



BASIC MANUAL

DUAL BAND TRANSCEIVER

ID-5100A ID-5100E



The photo shows the ID-5100E version.

This device complies with Part 15 of the FCC Rules. Operation is subject to the following two conditions: (1) this device may not cause harmful interference, and (2) this device must accept any interference received, including interference that may cause undesired operation.

WARNING: MODIFICATION OF THIS DEVICE TO RECEIVE CELLULAR RADIOTELEPHONE SERVICE SIGNALS IS PROHIBITED UNDER FCC RULES AND FEDERAL LAW.

Icom Inc.

Thank you for choosing this Icom product. This product is designed and built with Icom's state of the art technology and craftsmanship. With proper care, this product should provide you with years of trouble-free operation.

This product combines traditional analog technologies with the new digital technology, Digital Smart Technologies for Amateur Radio (D-STAR), for a balanced package.

IMPORTANT

READ ALL INSTRUCTIONS carefully and completely before using the transceiver.

SAVE THIS INSTRUCTION MANUAL— This instruction manual contains basic operating instructions for the ID-5100A/ID-5100E.

Icom, Icom Inc. and Icom logo are registered trademarks of Icom Incorporated (Japan) in Japan, the United States, the United Kingdom, Germany, France, Spain, Russia, Australia, New Zealand, and/or other countries.

Microsoft and Windows are registered trademarks of Microsoft Corporation in the United States and/or other countries.

Adobe, Acrobat, and Reader are either registered trademarks or trademarks of Adobe Systems Incorporated in the United States and/or other countries.



AMBE+2 is a trademark and property of Digital Voice Systems Inc.

The Bluetooth word mark and logos are registered trademarks owned by the Bluetooth SIG, Inc. and any use of such marks by Icom Inc. is under license. Other trademarks and trade names are those of their respective owners.

Android and the Android logo are trademarks of Google LLC.

All other products or brands are registered trademarks or trademarks of their respective holders.

EXPLICIT DEFINITIONS

WORD	DEFINITION
 DANGER!	Personal death, serious injury or an explosion may occur.
 WARNING!	Personal injury, fire hazard or electric shock may occur.
CAUTION	Equipment damage may occur.
NOTE	Recommended for optimum use. No risk of personal injury, fire or electric shock.

IMPORTANT NOTES

◆ Magnets

The optional MBA-2 controller bracket uses strong magnets to attach the bracket to the controller's rear panel.

 **DANGER! NEVER** place or attach the magnets on electronic medical equipment, such as an implanted cardiac pacemaker. It may affect the operation of the equipment. This could be life endangering.

BE CAREFUL not to pinch your finger when you attach the bracket to the controller's rear panel.

DO NOT put the controller near a clock, television set (CRT type), magnetic compass or any magnetic/IC cards, credit cards, and so on. The magnets may cause the products to malfunction or may erase the contents of magnetic storage devices.

IMPORTANT NOTES (Continued)

◇ When using the GPS receiver

- GPS signals cannot pass through metal objects. When using the ID-5100A or ID-5100E inside a vehicle, you may not receive GPS signals. We recommend you use it near a window. Please avoid the areas where:
 1. The driver's view will be blocked.
 2. The air bags could deploy.
 3. The unit becomes a driving obstacle.
- The Global Positioning System (GPS) is built and operated by the U.S. Department of Defence. The Department is responsible for accuracy and maintenance of the system. Any changes by the Department may affect the accuracy and function of the GPS system.
- When the GPS receiver is activated, please do not cover the remote controller with anything that will block the satellite signals.
- The GPS receiver may not work if used in the following locations:
 1. Tunnels or high-rise buildings
 2. Underground parking lots
 3. Under a bridge or viaduct
 4. In remote forested areas
 5. Under bad weather conditions (rainy or cloudy day)

SUPPLIED ACCESSORIES

The following accessories are supplied with the transceiver.

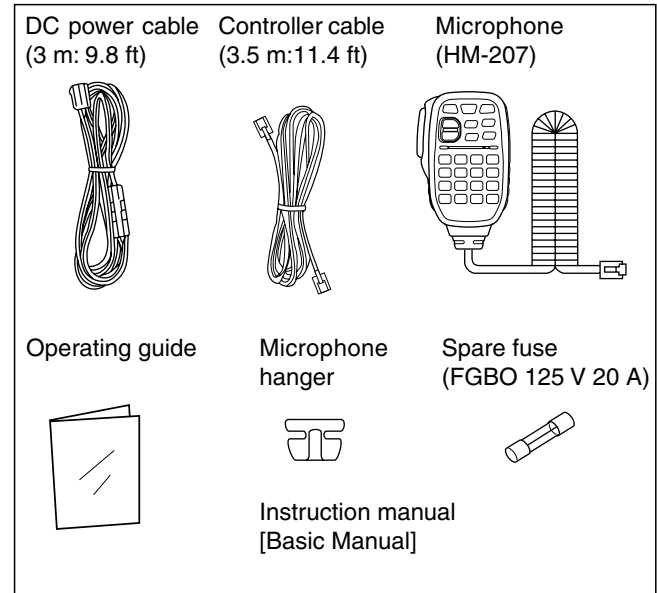

You can use the CS-5100 PROGRAMMING SOFTWARE, that can be downloaded from the Icom website, to setup the transceiver from your PC.

Refer to the CS-5100 instructions that can be downloaded from the Icom website, for details on the programming software.

ABOUT THE TOUCH SCREEN

◇ Touch screen precautions

Briefly touching the controller's touch operates the function.

- The touch screen may not properly work when LCD protection film or sheet is attached.
- Touching the screen with finger nails, sharp topped object and so on, or touching the screen hard may damage the screen.
- Tablet PC's operations such as flick input, pinch in and pinch out cannot be performed with this touch screen (based on the resistance film type).

◇ Touch screen maintenance

- If the touch screen becomes dusty or dirty, wipe it clean with a soft, dry cloth.
- When you wipe the touch screen, be careful not to push it too hard or scratch it with finger nails. Otherwise you may damage the touch screen.

◇ Touch operation

Ⓢ (Short touch): If the display is touched briefly, one short beep sounds.

Ⓛ (Long touch): If the display is touched for 1 second, one short and one long beep sound.

- After the beep, the operation is enabled.

 In the instruction manual, the touch operation is described as shown below.

 If the display is touched briefly, one short beep sounds.

 If the display is touched for 1 second, one short and one long beep sound.

◇ About the Touch area

Areas you can touch for various operations are shown to the right.

- This page describes the main operations of the touch screen. See the instruction manual for other operations.

ABOUT THE TOUCH SCREEN (Continued)

Dual or Single band display selection: **L**

- MAIN band: Used for TX or radio's settings
- SUB band: Used for the Dualwatch operation

"kHz" tuning selection: **S**

Tuning step selection: **L**

Sets MAIN band to the right side: **S**

Dual or Single band display selection: **L**

- In the Single band, touch [B] to set the B band as the MAIN band.

"MHz" tuning selection: **L**

Operating mode selection: **S**

Operating band selection: **S**

Sets the Mode: **S**

Displays the Monitor function: **S**

TX power selection: **S**

Function menu selection: **S**

Displays the Function menu list: **L**

Displays the Menu screen: **S**

Operating mode selection: **S**

Displays the date and time: **S**

Displays the GPS menu window: **S**

Sets MAIN band to the right side: **S**

Function menu operations

- The following operations are examples.

MW

Displays the Memory Write window: **S**

Writes to a blank CH: **L**

SCAN

Scan type selection: **S**

Starts a scan: **L**

- The last used scan starts.

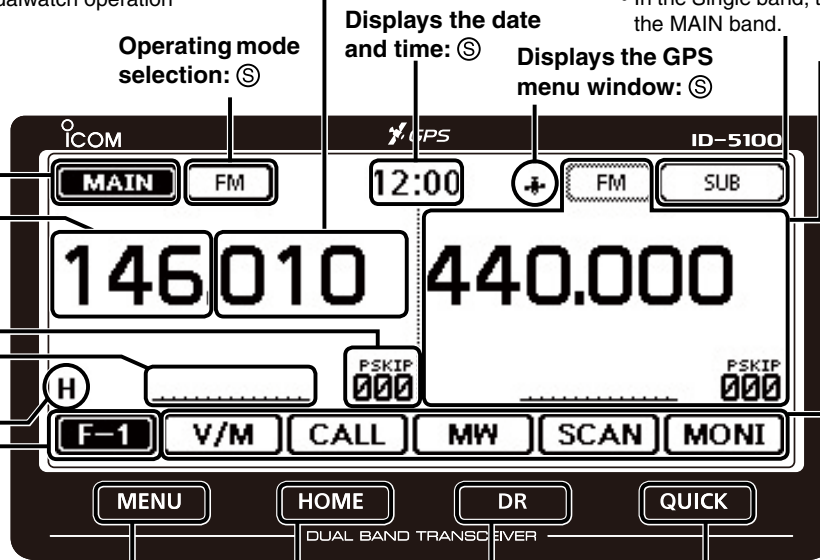

Home CH selection: **S**

- Selects the Home CH that you set in the QUICK Menu.

Home CH setting: **L**

Displays the DR screen: **S**

- D-STAR settings can easily be made.

Displays the QUICK Menu: **S**

- Releases mute when rotating [DIAL], [VOL] or [SQL], or operating a key, touch screen or microphone.

ABOUT THE MANUALS

You can use the following manuals to understand and operate this transceiver.

They are published at the following internet address:
<https://www.icomjapan.com/support/>

- **Basic Manual (This manual)**

Basic operating instructions, and are the same instructions that are in this manual

- **Full Manual (PDF type)**

Full operating instructions, and more details are described than in this manual

- **Operating Guide (Comes with the transceiver)**

Operating guide for using the touch screen, Menu items and Quick menu items. Contains the same information that is in the supplied leaflet.

For Reference

- **HAM radio Terms (PDF type)**

A glossary of HAM radio terms

To read the manuals, Adobe® Acrobat® Reader® is required. If you have not installed it, please download the Adobe® Acrobat® Reader® and install it to your PC.

You can download it from Adobe Systems Incorporated's website.

VOICE CODING TECHNOLOGY

The AMBE+2™ voice coding Technology embodied in this product is protected by intellectual property rights including patent rights, copyrights and trade secrets of Digital Voice Systems, Inc. This voice coding Technology is licensed solely for use within this Communications Equipment.

The user of this Technology is explicitly prohibited from attempting to extract, remove, decompile, reverse engineer, or disassemble the Object Code, or in any other way convert the Object Code into a human-readable form.

U.S. Patent Nos.

#8,595,002, #8,359,197, #8,315,860, #8,200,497,
#7,970,606, #6,912,495 B2.

PRECAUTIONS

⚠ **DANGER HIGH VOLTAGE! NEVER** touch an antenna connector during transmission. This may result in an electrical shock or burn.

⚠ **WARNING RF EXPOSURE!** This transceiver emits Radio Frequency (RF) energy. Extreme caution should be observed when operating this transceiver. If you have any questions regarding RF exposure and safety standards please refer to the Federal Communications Commission Office of Engineering and Technology's report on Evaluating Compliance with FCC Guidelines for Human Radio Frequency Electromagnetic Fields (OET Bulletin 65).

⚠ **WARNING! NEVER** operate the transceiver while driving a vehicle. Safe driving requires your full attention—anything less may result in an accident.

⚠ **WARNING! NEVER** operate the transceiver with an earphone or other audio accessories at high volume levels. Continuous high volume operation may cause a ringing in your ears. If you experience ringing, reduce the volume level or discontinue use.

⚠ **WARNING! NEVER** connect the transceiver to an AC outlet. This may pose a fire hazard or result in an electric shock.

⚠ **WARNING! NEVER** operate the transceiver during a lightning storm. It may result in an electric shock, cause a fire or damage the transceiver. Always disconnect the power source and antenna before a storm.

⚠ **WARNING! NEVER** connect the transceiver to a power source of more than 16 V DC such as a 24 V DC. This could cause a fire or damage the transceiver.

⚠ **WARNING! NEVER** reverse the DC power cable polarity when connecting to a power source. This could damage the transceiver.

⚠ **WARNING! NEVER** cut the DC power cable between the DC plug and fuse holder. If an incorrect connection is made after cutting, the transceiver may be damaged.

⚠ **WARNING! NEVER** let metal, wire or other objects touch any internal part or connectors on the rear panel of the transceiver. This may result in an electric shock or this could cause a fire or damage the transceiver.

⚠ **WARNING! NEVER** operate or touch the transceiver with wet hands. This may result in an electric shock or may damage the transceiver.

⚠ **WARNING!** Immediately turn the transceiver power OFF and remove the power cable if it emits an abnormal odor, sound or smoke. Contact your Icom dealer or distributor for advice.

CAUTION: NEVER expose the transceiver to rain, snow or any liquids.

PRECAUTIONS (Continued)

CAUTION: NEVER change the internal settings of the transceiver. This may reduce transceiver performance and/or damage to the transceiver.

CAUTION: NEVER place the transceiver where normal operation of the vehicle may be hindered or where it could cause bodily injury.

NEVER place the transceiver in an insecure place to avoid inadvertent use by unauthorized persons.

DO NOT operate the transceiver near unshielded electrical blasting caps or in an explosive atmosphere.

DO NOT push the PTT when not actually desiring to transmit.

DO NOT use harsh solvents such as benzene or alcohol to clean the transceiver, as they will damage the transceiver's surfaces. If the transceiver becomes dusty or dirty, wipe it clean with a soft, dry cloth.

DO NOT use or place the transceiver in areas with temperatures below -10°C ($+14^{\circ}\text{F}$) or above $+60^{\circ}\text{C}$ ($+140^{\circ}\text{F}$). Be aware that temperatures on a vehicle's dashboard can exceed $+80^{\circ}\text{C}$ ($+176^{\circ}\text{F}$) in direct sunlight, resulting in permanent damage to the transceiver if left there for extended periods.

DO NOT place the transceiver in excessively dusty environments or in direct sunlight.

DO NOT place the transceiver against walls or putting anything on top of the transceiver. This will obstruct heat dissipation.

During mobile operation, **NEVER** place the transceiver where air bag deployment may be obstructed.

During mobile operation, **DO NOT** place the transceiver where hot or cold air blows directly onto it.

During mobile operation, **DO NOT** operate the transceiver without running the vehicle's engine. When the transceiver's power is ON and your vehicle's engine is OFF, the vehicle's battery will soon become exhausted.

Make sure the transceiver power is OFF before starting the vehicle engine. This will avoid possible damage to the transceiver by ignition voltage spikes.

During maritime mobile operation, keep the transceiver and microphone as far away as possible from the magnetic navigation compass to prevent erroneous indications.

BE CAREFUL! The rear panel will become hot when operating the transceiver continuously for long periods of time.

Use Icom microphones only (supplied or optional). Other manufacturer's microphones have different pin assignments, and may damage the transceiver.

TABLE OF CONTENTS

IMPORTANT	i
EXPLICIT DEFINITIONS.....	i
IMPORTANT NOTES.....	i
SUPPLIED ACCESSORIES.....	ii
ABOUT THE TOUCH SCREEN.....	iii
ABOUT THE MANUALS.....	v
VOICE CORDING TECHNOLOGY.....	v
PRECAUTIONS.....	vi

NEW FUNCTIONS X

1 PANEL DESCRIPTION 1–10

■ Controller — Front panel.....	1
■ Controller — Display (Touch screen)	2
■ Main unit — Front and rear panels	7
■ Microphone (HM-207).....	8

2 BASIC OPERATION..... 11–18

■ Turning ON the power.....	11
■ Setting audio volume and squelch level.....	11
■ Selecting a tuning step.....	11
■ Selecting the watch mode.....	12
■ Selecting the operating band.....	13
■ Direct frequency input.....	14
■ Selecting the Mode and the DR function	15
■ Transmitting.....	16

■ Selecting the operating mode	17
■ Lock function.....	17
■ Home channel function	18
■ Speech function	18

3 MEMORY OPERATION..... 19–20

■ Writing Memory channels	19
■ Checking the Memory contents	19

4 D-STAR OPERATION..... 21–54

■ Unique features of D-STAR.....	21
■ D-STAR Introduction	22
■ About the DR (D-STAR Repeater) function.....	22
■ Ways to Communicate with the DR function.....	23
■ Enter your call sign into the transceiver	24
■ Register your call sign at a gateway repeater	27
■ Making a Simplex call	29
■ Accessing repeaters	31
■ Using the RX history	33
■ Capturing a call sign	35
■ Making a Local area call	37
■ Making a Gateway Repeater call	39
■ Calling an individual station	41
■ Troubleshooting.....	43
■ Reflector operation.....	45
■ Updating the repeater list.....	51

TABLE OF CONTENTS (Continued)

5 RECORDING A QSO ONTO AN SD CARD...55–58	9 MAINTENANCE 87–88
■ About the SD card.....55	■ Resetting.....87
■ Inserting the SD card.....56	■ Power protect function88
■ Recording a QSO audio.....57	■ Spurious signals88
■ Playing recorded audio58	■ Fuse replacement88
■ Removing the SD card.....58	
6 GPS OPERATION 59–60	10 INFORMATION..... 89–90
■ GPS operation59	DISPOSAL.....89
■ Checking your GPS position59	ABOUT CE AND DOC.....89
	FCC INFORMATION.....90
7 MENU SCREEN 61–79	INDEX..... 91–93
■ Menu item selection.....61	
■ Menu items and Default settings.....62	
8 INSTALLATION AND CONNECTIONS .. 80–86	
■ Connect controller to main unit80	
■ Microphone connection.....80	
■ DC power supply connection80	
■ Installing a controller.....81	
■ Installing in a vehicle.....83	
■ Installing an antenna.....84	
■ Battery connection.....85	
■ External GPS receiver connection86	

This section describes the new functions built into the ID-5100A/E.

- See the Full Manual for more details.

1 Two band monitoring in the DV mode

The transceiver can simultaneously monitor two different frequencies in the DV mode.

For example, while operating in the Simplex mode on the MAIN band, you can monitor a D-STAR repeater on the SUB band.

- While receiving or transmitting a DV signal on the MAIN band, DV mode audio from the SUB band will be muted.
- See Section 7 of the Full Manual for details.

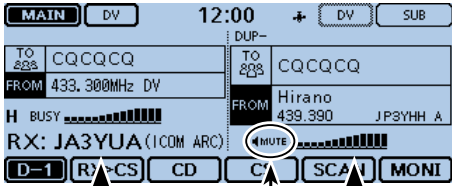

MAIN band
(You can hear the received audio)

Appears

SUB band
(The received audio is muted.)

2 Add-on functions for D-PRS

D-PRS enables the transceiver to transmit or receive the Object, Item or Weather data in addition to position data.

With the D-PRS add-on functions, you can receive information such as an event, traffic, emergency or weather while making a voice call in the DV mode.

- See Section 8 of the Full Manual for details.

D-PRS “TX FORMAT” screen in the Menu screen.
(GPS > GPS TX Mode > D-PRS > TX Format)

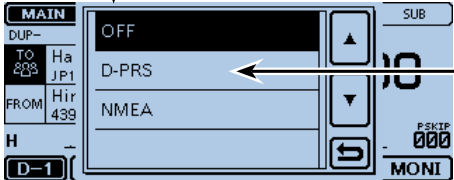
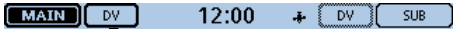
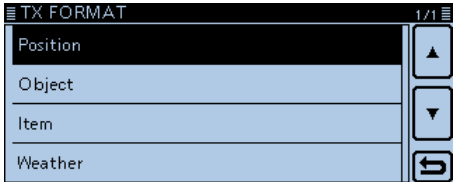

Touch to set the GPS TX format to “D-PRS.”

NEW FUNCTIONS

3 Memory management

You can easily edit the Memory or Call channel contents in the “MANAGE MEMORY” screen. You can view the contents on a list. (p. 19)

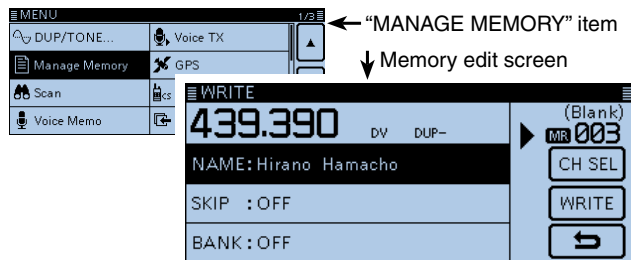

5 Near FM Repeater search function

You can enter FM repeater data using the DR function. The function can find only FM repeaters in your transceiver's repeater list.

- See Section 6 of the Full Manual for details.

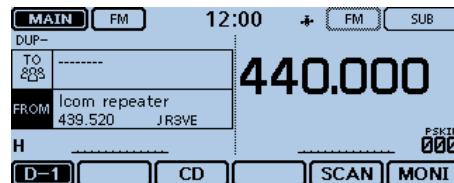

When FM repeater is selected.

4 Import and Export the CSV format file

You can easily import and export the repeater list. (p. 53)

- An SD card is required.

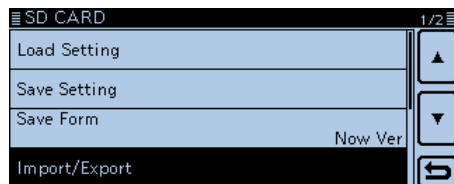

6 Bluetooth® operation

Installing the optional UT-133 Bluetooth® UNIT allows you to use a variety of Bluetooth® products.

- See Section 15 of the Full Manual for details.

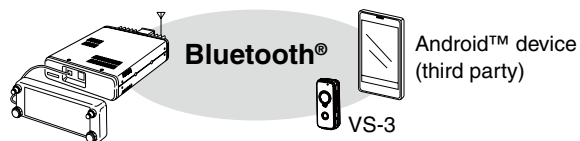

7 Calling through a reflector

When you link to a reflector, you can listen to activity on all the repeaters that are connected to the reflector, and easily make contacts. (p. 45)

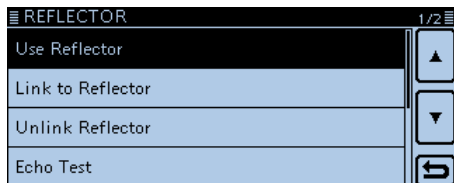

8 DV Fast data function

You can use the DV Fast Data function for the data communication in the DV mode.

The DV Fast Data function uses the data and the audio frames to send data approximately 3.5 times faster than the normal speed. So, no audio can be sent.

- See the PDF type Advanced Instruction's Section 9 for details.

■ Controller — Front panel

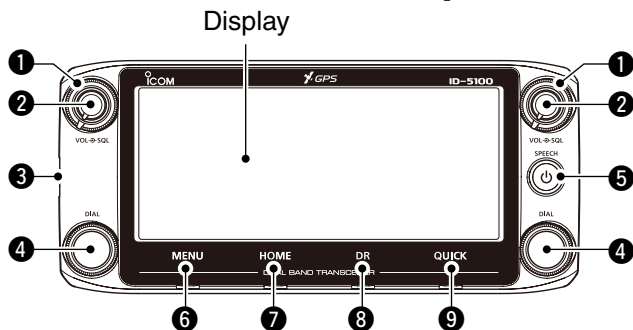

About control's operation

In the Dualwatch mode, the left side controls are used for the left side band, and the right side controls are used for the right side.

In the Single watch mode, the left side controls are used for the A band, and the right side controls are used for the B band.

① SQUELCH CONTROL [SQL]

Rotate to adjust the squelch level. (p. 11)

- Normally, set the squelch level to where noise and the “BUSY” icon just disappear. (closed)
- You can use the S-Meter Squelch or Attenuator function by rotating the control clockwise beyond the center position. (Section 2 of the Full Manual)

② VOLUME CONTROL [VOL]

Rotate to adjust the audio level. (p. 11)

③ MAIN UNIT CONNECTOR

Connect the controller to the Main unit using the supplied control cable. (p. 80)

④ TUNING DIAL [DIAL]

- ➔ In the VFO mode, rotate to select the operating frequency, and in the Memory mode, rotate to select a Memory channel. (p. 15)
- ➔ In the Menu screen or Quick Menu window, rotate to select a desired option or value.
- ➔ While scanning, rotate to change the scanning direction. (Section 4 of the Full Manual)

⑤ POWER/SPEECH KEY [⏻](SPEECH)

- ➔ Hold down for 1 second to turn power ON or OFF. (p. 11)
- ➔ Push to audibly announce the operating frequency, mode or a selected call sign. (p. 18)

⑥ [MENU] (Touch screen) (p. 61)

Touch to open the Menu screen.

⑦ [HOME] (Touch screen)

- ➔ Touch to select the Home channel.
- ➔ Touch for 1 second to set the Home channel. (p. 18)

⑧ [DR] (Touch screen) (p. 16)

Touch to open the DR screen.

⑨ [QUICK] (Touch screen)

- ➔ Touch to open the Quick Menu window.
- ➔ Touch for 1 second to mute the audio. (p. 11)

■ Controller — Display (Touch screen)

Dualwatch mode

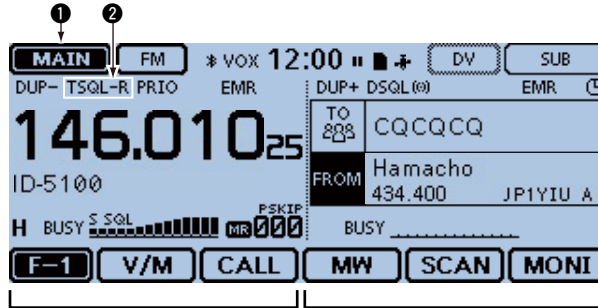

In the Single watch mode: A band In the Single watch mode: B band

Single watch mode (A band)

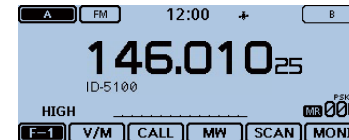

Single watch mode (B band)

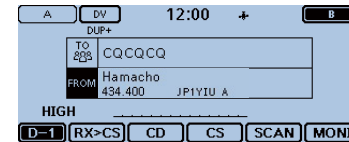

1 MAIN/SUB BAND ICON

In the Dualwatch mode, this icon will be highlighted to indicate the MAIN band.

“SUB” is displayed on the SUB band. (p. 12)

2 TONE/DIGITAL SQUELCH ICONS (Section 15 of the Full Manual)

Displayed when you set any tone or digital squelch function.

(Mode: FM/FM-N)

- “TONE” Repeater Tone
- “TSQL ((·))” Pocket Beep by Tone Squelch
- “TSQL” Tone squelch
- “DTCS ((·))” Pocket Beep by DTCS Code Squelch
- “DTCS” DTCS Code Squelch
- “TSQL-R” Reverse Tone Squelch
- “DTCS-R” Reverse DTCS Code Squelch

➤ “DTCS (T)”

TX: DTCS, RX: OFF

- “DTCS” blinks.

➤ “TONE (T)/DTCS (R)”

TX: TONE, RX: DTCS

- “T-DTCS” is displayed (“T” blinks).

➤ “DTCS (T)/TSQL (R)”

TX: DTCS, RX: CTCSS

- “D-TSQL” is displayed (“D” blinks).

➤ “TONE (T)/TSQL (R)”

TX: TONE, RX: CTCSS

- “T-TSQL” is displayed (“T” blinks).

(Mode: DV)

➤ “DSQL ((·))”

Pocket Beep by Digital Call sign Squelch

➤ “DSQL”

Digital Call Sign squelch.

➤ “CSQL ((·))”

Pocket Beep by Digital Code squelch

➤ “CSQL”

Digital Code squelch

1 PANEL DESCRIPTION

■ Controller — Display (Touch screen) (Continued)

Dualwatch mode

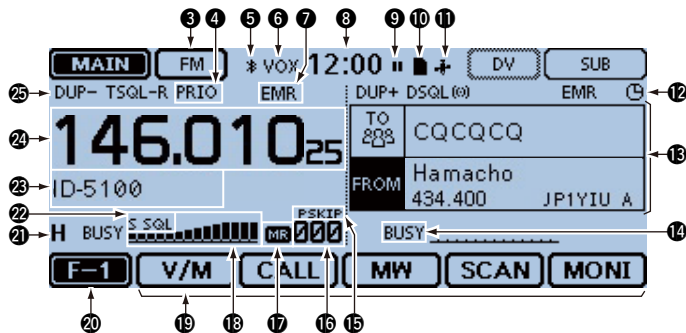

Single watch mode (A band)

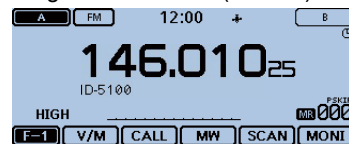

Single watch mode (B band)

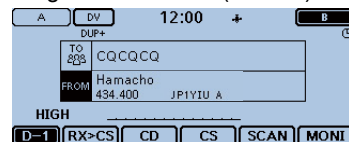

3 MODE ICONS

Displays the selected operating mode. (p. 17)

- In the DV mode, “DV” is displayed when you set the GPS TX Mode to “D-PRS” or “NMEA.”

4 PRIORITY ICON

Displayed when Priority watch is turned ON.

5 Bluetooth® ICON (Section 15 of the Full Manual)

Displayed when you make a Bluetooth® connection between your transceiver that has the optional UT-133 Bluetooth® UNIT installed and a Bluetooth® device.

6 VOX ICON (Section 15 of the Full Manual)

Displayed when you make a Bluetooth® connection between your transceiver that has the optional UT-133 Bluetooth® UNIT installed and the optional VS-3 Bluetooth® HEAD-SET, and the VOX function is ON.

7 EMR/BK/Packet Loss/Auto Reply ICON

- ➔ “EMR” is displayed when you select the Enhanced Monitor Request (EMR) mode.
- ➔ “BK” is displayed when you select the Break-in (BK) mode.
- ➔ “L” is displayed when packet loss has occurred.
- ➔ “A” is displayed when you select the Automatic Reply function.





8 CLOCK READOUT

Displays the current time.

9 RECORD ICON

Displayed while recording.

- “” is displayed while the transceiver is recording.
- “” is displayed while the recording is paused.

- ⑩ **SD ICON** (p. 56)
 - “” is displayed when a SD card is inserted.
 - “” and “” alternately blinks while accessing the SD card.
- ⑪ **GPS ICON**
 - Displays the status of the GPS receiver. (p. 59)
 - “”)” is displayed when you set the GPS alarm. (Section 8 of the Full Manual)
- ⑫ **AUTO POWER OFF ICON** (p. 61)
Displayed when the Auto power OFF function is ON.
- ⑬ **DR SCREEN** (pp. 16, 22)
Displays the DR screen where the D-STAR settings are made.
- ⑭ **BUSY/MUTE ICON** (Section 2 of the Full Manual)
 - “BUSY” is displayed while a signal is being received or the squelch is open.
 - “BUSY” blinks while the monitor function is activated.
 - “MUTE” is displayed while the mute is activated.
- ⑮ **SKIP ICON** (Section 4 of the Full Manual)
Displays the selected Skip function.
 - “SKIP”: Memory skip
 - “PSKIP”: Program skip
- ⑯ **MEMORY CHANNEL NUMBER** (p. 15)
 - Displays the selected Memory channel number, Memory Bank, and so on.
 - “WX” is displayed when the Weather channel mode is ON.*
*Only the USA version transceiver.
- ⑰ **MEMORY ICON** (p. 15)
Displayed when the Memory mode is selected.

- ⑱ **S/RF METER** (Section 2 of the Full Manual)
 - Displays the relative signal strength of the receive signal.
 - Displays the output power level of the transmit signal.
- ⑲ **FUNCTION MENU DISPLAY**
Displays the touch key, according to the selected function menu group. (p. 5)
- ⑳ **FUNCTION GROUP ICON**
Displays the selected function group (F-1 to F-4, D-1 to D-3) (p. 5)
- ㉑ **POWER ICONS** (Section 2 of the Full Manual)
 - Displays the output power level of the transmit signal in three levels.
 - In the Dualwatch mode:
 - “H” is displayed when you select high power.
 - “M” is displayed when you select mid power
 - “L” is displayed when you select low power.
- ㉒ **S-METER SQUELCH/ATTENUATOR ICONS** (Section 2 of the Full Manual)
 - “S SQL” is displayed when the S-meter squelch is activated.
 - “ATT” appears when the Attenuator function is activated.
- ㉓ **MEMORY NAME DISPLAY** (Section 3 of the Full Manual)
In the Memory mode, displays the programmed memory name.
- ㉔ **FREQUENCY READOUT**
Displays the operating frequency. (p. 14)
- ㉕ **DUPLEX ICON** (Section 11 of the Full Manual)
“DUP-” is displayed when minus duplex is selected, and “DUP+” is displayed when plus duplex is selected.

1 PANEL DESCRIPTION

■ Controller — Display (Touch screen) (Continued)

◇ Function menu

You can toggle the function group to select the desired function keys to operate the transceiver, depending on the transceiver's operating mode or status.

Each function key works for the MAIN band.

- In the VFO, Memory or Call channel mode, you can select the F-1 to F-4 menus.
- In the DR screen, you can select the D-1 to D-3 menus.

- ➔ Touch the group icon to toggle the function group.
- ➔ Touch the group icon for 1 second to display the function menu list.



- 1 [V/M]**
Touch to toggle between the VFO and Memory modes.
- 2 [CALL]**
Touch to turn the Call channel mode ON or OFF.
- 3 [MW]**
 - ➔ Touch to open the Memory Write window.
 - ➔ In the VFO mode or the DR screen, touch for 1 second to store the operating data into the blank channel.
 - ➔ In the Memory or Call channel mode, touch for 1 second to open the Memory Edit screen.

- 4 [SCAN]**
 - ➔ Touch to open the Scan type setting window.
 - ➔ Touch for 1 second to start the last used scan.

- 5 [MONI]**
Touch to turn the Monitor function ON or OFF.

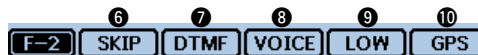

- 6 [SKIP]**
(Displayed in the Memory mode.)
Touch to open the Scan Skip setting window.
- 7 [DTMF]**
Touch to open the DTMF send window.
- 8 [VOICE]**
When you insert an SD card into the transceiver's SD card slot, touch to open the "VOICE TX" screen.
- 9 [LOW]**
Touch to open the TX power setting window.
- 10 [GPS]**
Touch to open the GPS item setting window.



- 11 [DUP]**
Touch to open the duplex direction setting window.
- 12 [TONE]**
(Displayed only when in the FM/FM-N mode.)
Touch to open a Tone function setting window.
- 13 [REC]**
When you insert an SD card into the transceiver's SD card slot, touch to start recording a QSO (communication) audio.
- 14 [SCOPE]**
Touch to open the sweep item setting window.
- 15 [▶□]**
(Displayed only when you select a sweep operation in [SCOPE](14).)
 - Touch to start a single sweeping.
 - Touch for 1 second to start a continuous sweeping.
 - While sweeping, touch to stop it.



- (Displayed only when in the DV mode.)
- 16 [RX>CS]**
 - Touch to open the "RX>CS" screen.
 - Touch for 1 second to set the received station call sign as the destination (UR) call sign.
 - 17 [CD]**
Touch to open the "RX HISTORY" screen.
 - 18 [CS]**
Touch to open the "CALL SIGN" screen.

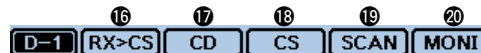

- 19 [SCAN]**
 - Touch to open the DR scan setting window.
 - Touch for 1 second to start the last used scan.
- 20 [MONI]**
Touch to turn the Digital Monitor function ON or OFF.

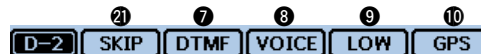

- 21 [SKIP]**
 - Touch to open the skip setting window for the Access repeater scan.
 - Touch for 1 second to set the skip setting in the Function menu.

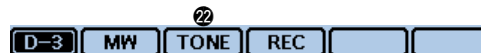
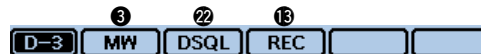

- 22 [DSQ1]**
(Displayed in the DV mode.)
Touch to open the Digital squelch function setting window. If you set the operating mode to "DV" in the VFO mode, [DSQ1] is displayed instead of [TONE] on the F-3 menu.
- [TONE]**
(Displayed when an analog repeater is selected in the DR screen for the EUR or ITR version transceiver.)
While holding down [PTT], touch [TONE] to send the 1750 Hz tone.

1 PANEL DESCRIPTION

■ Main unit — Front and rear panels

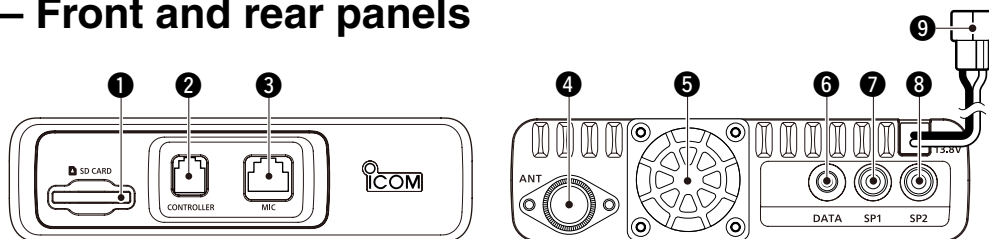

1 SD CARD SLOT [SD CARD]

Insert an SD card (purchase separately). (p. 52)

2 CONTROLLER CONNECTOR [CONTROLLER]

Connects to the Controller using the supplied control cable.

3 MICROPHONE CONNECTOR [MIC]

Plug in the supplied microphone (HM-207) or the optional microphone (HM-154).

4 ANTENNA CONNECTOR

Connect a 50 Ω impedance of antenna with a PL-259 connector.

The transceiver has a built-in duplexer, so you can use a 144 and 430 MHz dual-band antenna without needing an external duplexer.

5 COOLING FAN

The cooling fan for heat dissipation.

You can select the Fan control option in the Menu screen, and automatically starts to rotate when you begin transmitting, or continuously rotates from power ON.

6 DATA JACK [DATA]

Connect a PC through the optional data communication cable, for cloning or data communication in the DV mode. (Section 13 of the Full Manual)

7 EXTERNAL SPEAKER JACK 1 [SP1]

8 EXTERNAL SPEAKER JACK 2 [SP2]

➤ Connect to an 8 ohm external speaker.

- When you connect external speakers to [SP1] and [SP2], the A band (left side display) audio is heard from [SP1] and the B band (right side display) audio is heard from [SP2].

- When you connect an external speaker to [SP1], the A and B band audio is heard from [SP1]. In this case, the internal speaker is disabled.

- When you connect an external speaker to [SP2], the A band (left side display) audio is heard from the internal speaker and the B band (right side display) audio is heard from the external speaker.

➤ The [SP2] jack is used for external control of the transceiver. (Section 1 of the Full Manual)

9 DC POWER SOCKET [DC 13.8V]

Connect 13.8 V DC power source through the supplied DC power cable.

◇ Microphone connector information

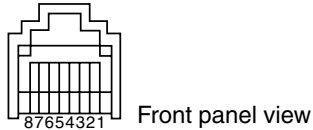

PIN No.	NAME	DESCRIPTION	SPECIFICATIONS
1	8 V	+8 V DC output.	Maximum 10 mA
2	MIC U/D	Frequency Up/Down	UP: Ground DN: Ground through 470 Ω
3	M8V SW	HM-207 connection Grounds when the HM-207 is connected.	—
4	PTT	PTT input	Ground for transmission
5	MIC E	Microphone ground	—
6	MIC	Microphone input	—
7	GND	PTT ground	—
8	DATA IN	When the HM-207 is connected, inputs HM-207 data	—

■ Microphone (HM-207)

With the HM-207, you can input numbers for frequency or Memory channel setting, and easily adjust the audio volume or squelch level.

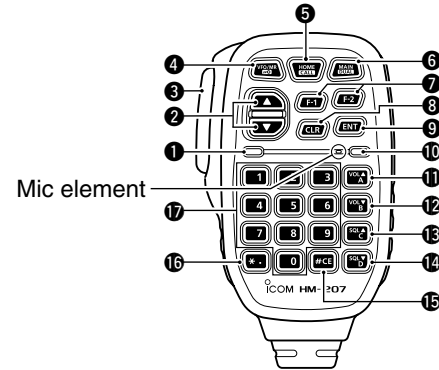

1 LED 1

Lights red while transmitting with [PTT].

2 [▲]/[▼] (UP/DOWN) KEYS

- Push to change the operating frequency or Memory channel.
- Hold down to continuously change the frequency or Memory channel.

1 PANEL DESCRIPTION

■ Microphone (HM-207) (Continued)

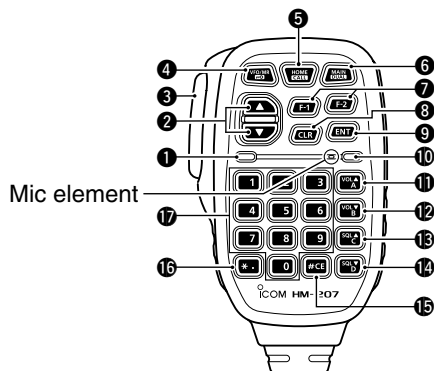

3 [PTT] SWITCH

Hold down to transmit, release to receive.

4 [VFO/MR] KEY

- ➔ Push to toggle between the VFO and Memory modes.
- ➔ Hold down for 1 second to turn the Lock function ON or OFF. (p. 17)

5 [HOME/CALL] KEY

- ➔ Push to select the Home channel.
- ➔ Hold down for 1 second to turn the Call channel mode ON or OFF.

6 [MAIN/DUAL] KEY

- ➔ In the Single watch mode, push to toggle between the A and B bands.
- ➔ In the Dualwatch mode, push to toggle between the MAIN and SUB bands.
- ➔ Hold down for 1 second to toggle between the Dualwatch and Single watch modes.

7 [F-1] KEY

Push to activate the preprogrammed function of the [F-1] key.

(Default: During RX/Standby: [BAND/BANK]
During TX: [T-CALL])

[F-2] KEY

Push to activate the preprogrammed function of the [F-2] key.

(Default: During RX/Standby: [Monitor]
During TX: [---])

/// You can assign a desired function in the Menu screen.

8 [CLR] KEY

In the Menu screen or Quick Menu window, push to return to the standby screen.

9 [ENT] KEY

- ➔ In the VFO mode, push to open the frequency entry window.
- ➔ In the Memory mode, push to open the memory channel number input window.
- ➔ After the numeral input, push to set.

10 LED 2

Lights green when transceiver's power is ON.

11 [VOL▲/A] KEY

- Push to increase the audio output level.
- When entering a DTMF code, push to input 'A.'

12 [VOL▼/B] KEY

- Push to decrease the audio output level.
- When entering a DTMF code, push to input 'B.'

13 [SQL▲/C] KEY

- Push to increase the squelch level.
- When entering a DTMF code, push to input 'C.'

14 [SQL▼/D] KEY

- Push to decrease the squelch level.
- When entering a DTMF code, push to input 'D.'

15 [# / CE] KEY

- In the frequency entry screen, push to delete a number.
- When entering a DTMF code, push to input '#.'

16 [* / .] KEY

- In the frequency entry screen, push to input a '.' (decimal point).
- When entering a DTMF code, push to input '*.'

17 [0] to [9] KEYS

In the frequency entry window or while entering a DTMF code, push to input '0' through '9.'

◇ Setting frequency and Memory channel**[Example for frequency setting]**

First, push [VFO/MR•>] to select the VFO mode.

To enter the 435.680 MHz frequency:

- Push [4], [3], [5], [6], [8], [0], then [ENT].

To change the 435.680 MHz to 435.540 MHz:

- Push [•], [5], [4], [0], then [ENT].

To enter the 433.000 MHz frequency:

- Push [4], [3], [3], then [ENT].

[Example for Memory channel setting]

First, push [VFO/MR•>] to select the Memory mode.

To select the Memory channel '5':

- Push [5] then [ENT].

■ Turning ON the power

- ➔ Hold down [⏻] for 1 second to turn ON the power.
 - A beep sounds and, after the opening message and power source voltage are displayed, the operating frequency appears.
 - Hold down [⏻] for 1 second to turn OFF the power.

■ Setting audio volume and squelch level

- ① Rotate [VOL] to adjust the audio level.
- ② Rotate [SQL] until the noise and the “BUSY” icon just disappear.
 - Rotating [SQL] clockwise makes the squelch tight. The tight squelch is for strong signals.
 - When rotating [SQL] clockwise beyond the center position, [SQL] can be used as ‘S-meter Squelch’ or ‘Attenuator.’ Select the [SQL] option in the Menu screen. (p. 71)

- ➔ To mute the audio, touch [QUICK] for 1 second.
 - Releases mute when rotating [DIAL], [VOL] or [SQL], or operating a key, touch screen or microphone.

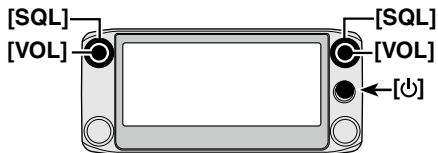

■ Selecting a tuning step

Rotating [DIAL] changes the frequency in the selected tuning steps.

The VFO scan uses this step to search for a signal.

Tuning steps (kHz)

5	6.25	8.33*	10	12.5	15
20	25	30	50	Auto*	

*Appears only when the AIR band is selected.

◇ Tuning step selection

- ① Touch the kHz digits for 1 second.
 - Opens the Tuning step setting window.

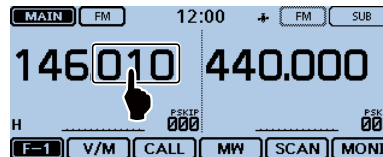

- ② Touch the desired tuning step.
 - Sets the tuning step, and then returns to the previous screen.
 - You can set the tuning step for both the VFO and Memory mode.
 - You can set the tuning step for each band.
 - In the Tuning step setting window, rotating [DIAL] also selects the tuning step.

■ Selecting the watch mode

The transceiver has two independent watch modes: Dualwatch mode and Single watch mode.

Dualwatch mode

The Dualwatch mode uses the MAIN and SUB bands, and you can simultaneously monitor both bands.

In the Dualwatch mode, both MAIN and SUB bands are displayed side by side.

Touching [MAIN] or [SUB] for 1 second selects the Single watch mode.

Single watch mode

The Single watch mode uses the A and B bands, instead of the MAIN and SUB bands, and you can monitor one of them at a time.

In the Single watch mode, only one of the A or B bands is displayed.

Touching [A] or [B] for 1 second selects the Dualwatch mode.

NOTE: The Dualwatch left side band becomes the A band in the Single watch mode.
The Dualwatch right side band becomes the B band in the Single watch mode.

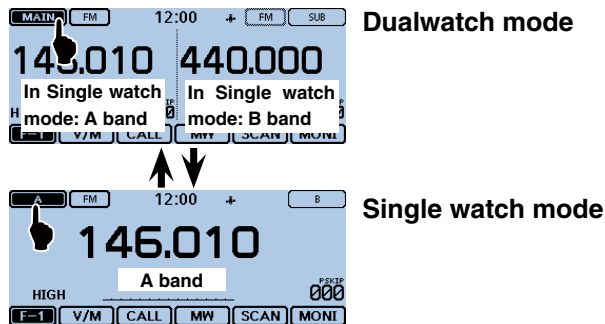

◇ Selecting the MAIN or SUB band

- ▶ Touch [SUB] to toggle the displayed band between the MAIN band and the SUB band.
 - [MAIN] will be highlighted to indicate the MAIN band.

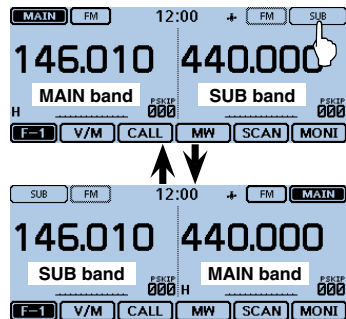

2 BASIC OPERATION

■ Selecting the operating band

The transceiver can receive the AIR, 144 MHz or 430 MHz bands.

The frequency range on each operating band is shown below.

You can transmit on only the 144 MHz and 430 MHz bands.

Operating band	Frequency range
AIR	118.000 MHz to 136.99166 MHz
144 MHz	137.000 MHz to 174.000 MHz
430 MHz	375.000 MHz to 550.000 MHz

The ranges may differ, depending on the transceiver version.

◇ Operating band setting

- ① Touch the Memory channel number.

• Opens the Mode setting window.

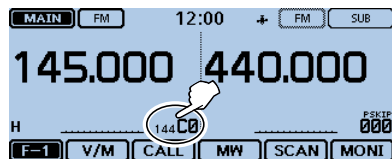

- ② Touch [VFO].

• Selects the VFO mode.



- ③ Touch the MHz digits.

• Opens the operating band setting window.

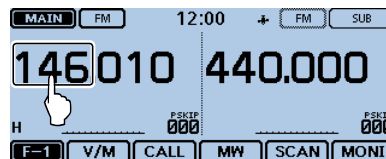

- ④ Touch the desired operating band.

• The operating band setting window disappears.

• Touch [F-INP] to open the frequency entry window. You can directly enter a frequency.

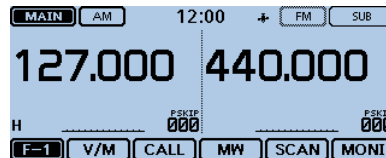
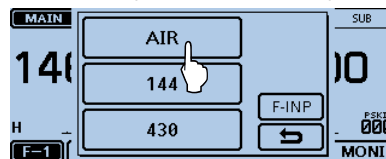

■ Direct frequency input

You can directly enter a frequency in the frequency entry window.

- ① Touch the Memory channel number.
 - Opens the Mode setting window.

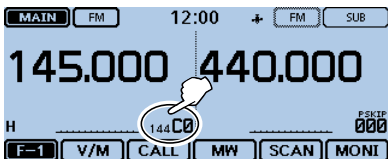

- ② Touch [VFO].
 - Selects the VFO mode.
- ③ Touch the MHz digits.
 - Opens the operating band setting window.

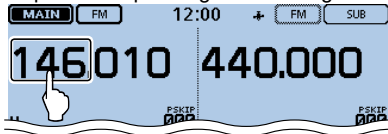

- ④ Touch [F-INP].
 - Opens the frequency entry window.

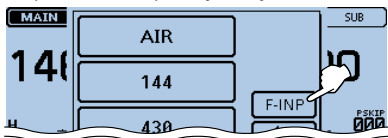

- ⑤ Touch the numbers to enter the desired frequency.
 - The first entered digit is displayed to the left. Then the next entered digit is displayed to the right of the previously entered digit.
 - If desired, touch "CE" to delete the entry.

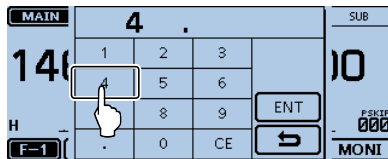

- ⑥ Touch [ENT] to set the frequency.
 - Closes the frequency entry window.
 - If you touch [ENT] without entering a digit below 100 kHz, all unentered digits are set to "0."

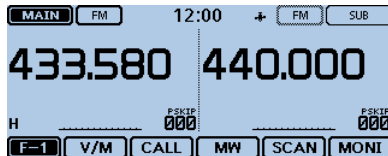
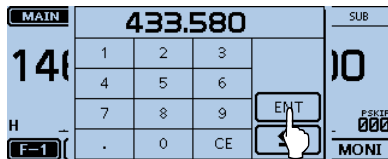

The entered frequency is displayed.

■ Selecting the Mode and the DR function

◇ VFO/Memory/Call channel/Weather channel* mode

VFO mode

The VFO mode is used to set the operating frequency.

Memory mode

The Memory mode is used to operate on Memory channels.

Call channel mode

The Call channel mode is used to operate on the most-often used frequencies.

Weather channel mode*

The Weather channel mode is used to monitor weather channels from the NOAA (National Oceanographic and Atmospheric Administration) broadcasts.

*Selectable in only the U.S.A. version transceivers.

- ① Touch the Memory channel number.
 - Opens the Mode setting window.

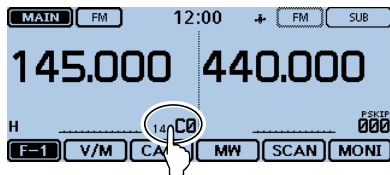

- ② Select the desired Mode.

- ③ Rotate [DIAL] to select the operating frequency or a channel.
 - “MR” and the selected Memory channel number are displayed.
 - A selected Call channel number (“144 C0,” “144 C1,” “430 C0” or “430 C1”) is displayed.
 - The selected weather channel number (“WX-01” to “WX-10”) is displayed.

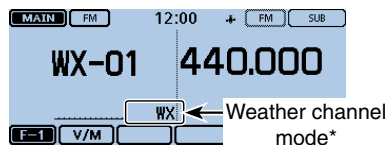
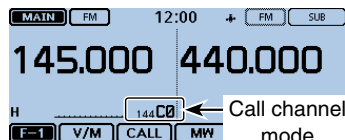
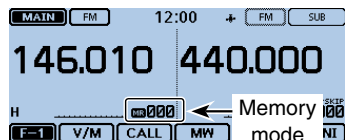
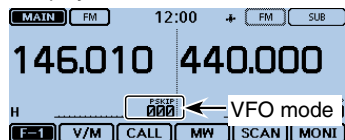

◇ DR (D-STAR Repeater) function selection

The DR (D-STAR Repeater) function is for D-STAR repeater operation. In this mode, you can easily select the pre-programmed repeaters and UR call signs by rotating [DIAL]. See page 21 for the DR function details.

- ① Touch [DR].
 - Displays the DR screen.

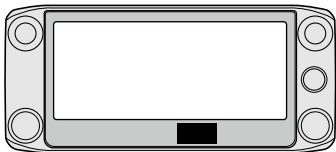

[DR]

- ② Rotate [DIAL] to select a desired access repeater.

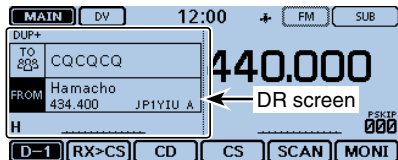

- ③ Touch [DR].
 - Closes the DR screen.

■ Transmitting

◇ Transmitting on an Amateur band

Before transmitting, monitor the operating frequency to make sure transmitting won't cause interference to other stations on the same frequency.

- /// **CAUTION: DO NOT** transmit without an antenna.
- /// You can transmit on only the 144 MHz and 430 MHz bands.

- ① Set the operating frequency. (p. 14)
- ② Touch the Power icon.
 - Opens the output power level setting window.
- ③ Touch the transmit output power level.
 - Select a level to suit your operating requirements.
 - In the Dualwatch mode, “H” indicates high power, “M” indicates mid power and “L” indicates low power.
- ④ Hold down [PTT] to transmit, and speak at your normal voice level.
 - The transmit LED lights red while transmitting.
 - The S/Rf meter displays the output power level.
- ⑤ Release [PTT] to receive.

2 BASIC OPERATION

■ Selecting the operating mode

Operating modes are determined by the modulation of the radio signals. The transceiver has a total of five operating modes, AM, AM-N, FM, FM-N and DV.

The FM mode is set as a default.

① Touch the Mode icon.

- Opens the operating mode setting window.

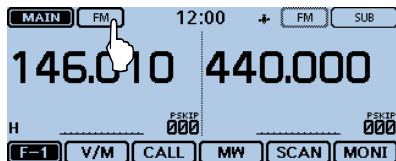

② Touch a desired operating mode.

- You can select the AM or AM-N mode for only the AIR band (118.000 MHz to 136.99166 MHz).
- You can select the FM, FM-N or DV mode for only the 144 and 430 MHz bands.
- While in the FM-N mode, the TX modulation is automatically set to narrow (approximately ± 2.5 kHz)
- While in the DV mode, [GPS] appears in the operating mode setting window, and you can select the GPS TX mode. When the GPS TX mode is set, "[DV GPS]" is displayed. (Section 8 of the Full Manual)

■ Lock function

You can use the Lock function to prevent accidental frequency changes and unnecessary function access.

① Touch [QUICK].

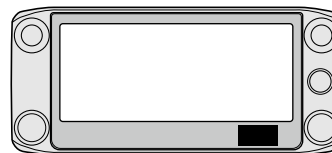

[QUICK]

② Touch "<<Lock>>".

- If the item is not displayed, touch [▲] or [▼] one or more times to select another page.
- When the Lock function is turned ON and the locked key is pushed, the touch screen is touched, or [DIAL] is rotated, the "LOCK" dialog box appears.
- To turn OFF the Lock function, touch [OFF] in the "LOCK" dialog box.
- You can still use [P], [PTT], [SQL] and [VOL] while the Lock function is ON.

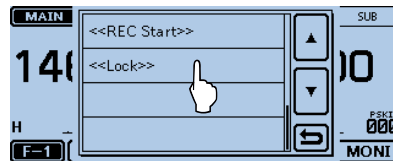

Quick Menu window

■ Home channel function

Home channels are often-used frequencies you can preset in the transceiver's VFO mode, Memory mode and DR function. Select the Home channel function by just touching [HOME] in each mode.

◇ Home channel setting

- ① Select the desired mode or the DR screen to set the Home channel.
- ② Select a frequency to be set as the Home channel.
 - While in the DR screen, select "FROM."
- ③ Touch [HOME] for 1 second.
- ④ Touch the displayed item to set the Home channel.
 - While in the VFO mode, touch "Set Frequency;" while in the Memory mode, touch "Set Channel;" or while in the DR screen, touch "Set Repeater."

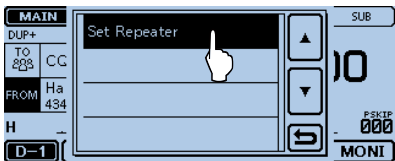

■ Speech function

When you push [SPEECH], the Speech function audibly announces the displayed frequency and operating mode in the VFO, Memory or Call channel modes, or the call sign of the DR function.

Also, you can use other speech functions, such as the [DIAL] speech function and Mode speech function.

NOTE: When you push [SPEECH] while recording the received audio in the DV mode, the received audio will be muted, and no audio is recorded onto the SD card. In modes other than the DV mode, the received audio will be recorded.

You set the detail settings of the Speech function in the "SPEECH" item of the Menu screen. (Section 13 of the Full Manual)

Example: When pushing [SPEECH].

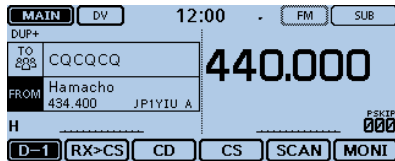

[SPEECH]

JP1YIU A

3

MEMORY OPERATION

■ Writing Memory channels

The Memory mode is useful to quickly select often-used repeaters.

In this section, the basic channel programming is described. See the Full Manual for details.

Example: Writing 146.030 MHz/FM mode into a blank channel.

- ① Touch the Function group icon one or more times.
 - Selects the F-1 menu.
- ② Touch [MW] for 1 second.
 - The memory contents are briefly displayed, and then the operating data are saved into a blank channel.

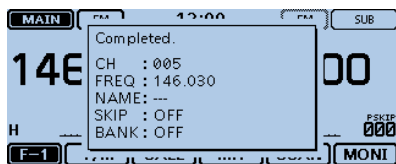
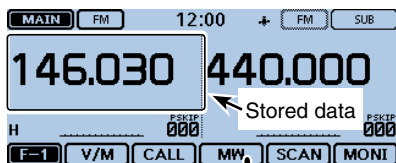

■ Checking the Memory contents

The contents of the Memory channels can be checked on the "MEMORY LIST" screen.

Example: Checking the contents of Memory channel 5.

- ① Touch [MENU].
- ② Touch "Memory CH."
 - (Manage Memory > Memory CH)
 - If the item is not displayed, touch [▲] or [▼] one or more times to select the page.

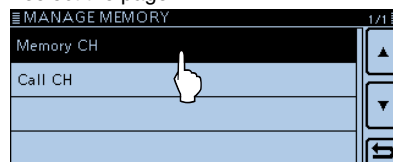

- ③ Touch "ALL."
 - Displays the "MEMORY CH ALL" screen.

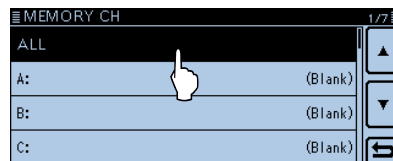

- ④ Touch [▲] or [▼].
- Displays Channel 5.

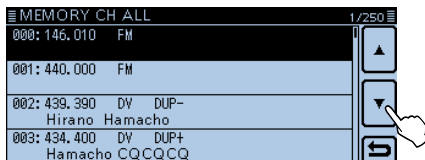

- ⑤ Touch "005."
- Displays the data in Channel 5.
 - Touch [▲] or [▼] one or more times to select the page.

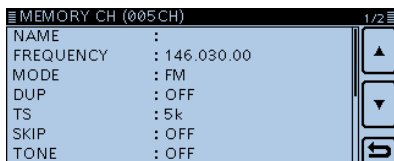
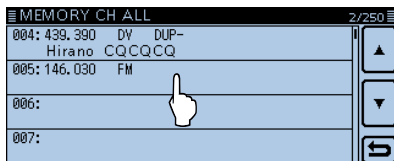

- ⑥ Touch [MENU].
- Closes the "MEMORY CH ALL" screen.

4 D-STAR OPERATION

■ Unique features of D-STAR

- Easy Cross band operation through the repeater
- Easy call sign entry with the Repeater list or TX/RX History
- Call Sign Capture key [RX>CS] makes call sign capture easy.

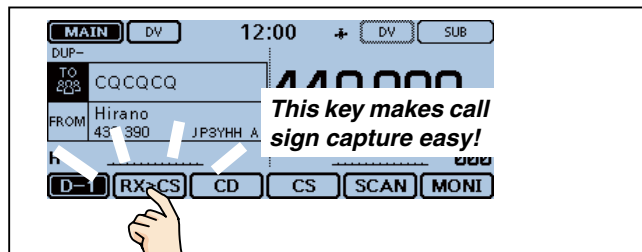
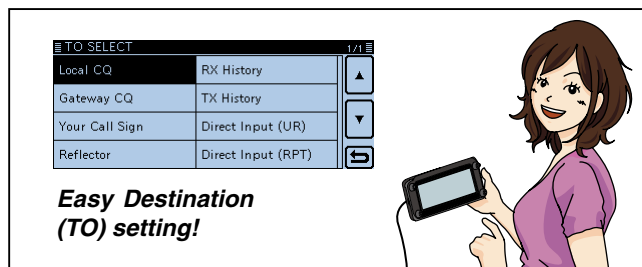
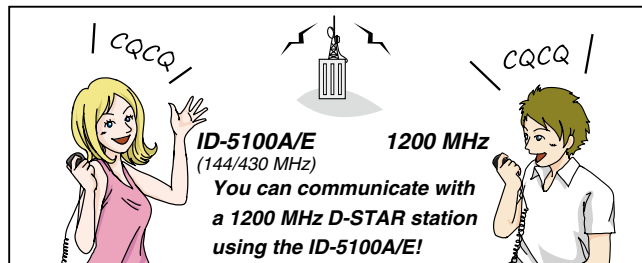

Before starting D-STAR, the following steps are needed.

IMPORTANT! **STEP 1** Entering your call sign (MY) into the transceiver. → **STEP 2** Registering your call sign (MY) to a gateway repeater. → **STEP 3** Entering your D-STAR equipment into your registration form. → You have completed the steps!!

See pages 24 to 28 for details.

■ D-STAR Introduction

- In the original D-STAR (Digital Smart Technologies for Amateur Radio) plan, JARL envisioned a system of repeaters grouped together into Zones.
- The D-STAR repeater enables you to call a HAM station near you, or around the world.

- You can transmit and receive digital voice, including low-speed data, at the same time. You can transmit and receive position data from the built-in GPS receiver.

■ About the DR (D-STAR Repeater) function

You can easily use the D-STAR repeaters with the DR (D-STAR Repeater) function. With this function, you can select the preprogrammed repeater or frequency in “FROM” (the access repeater or simplex), and UR call sign in “TO” (destination), as shown to the right.

NOTE: If the repeater set in “FROM” (Access Repeater) has no Gateway call sign, you cannot make a gateway call.

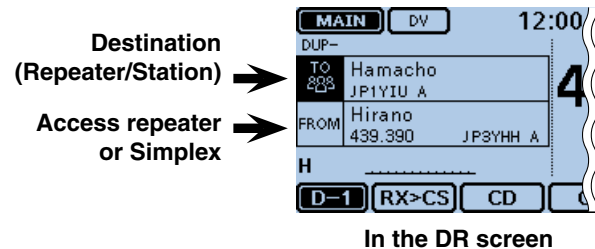

4 D-STAR OPERATION

■ Ways to Communicate with the DR function

With the DR function, the transceiver has three ways to communicate, as shown below.

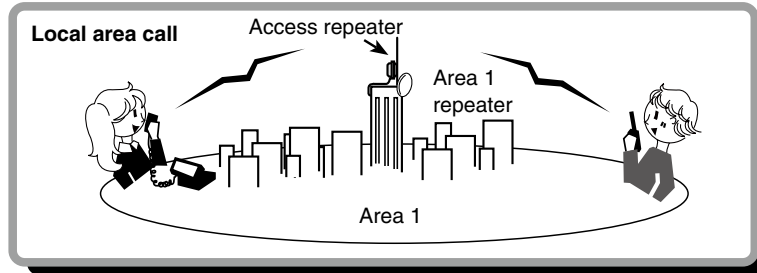

To call through your local area (access) repeater.

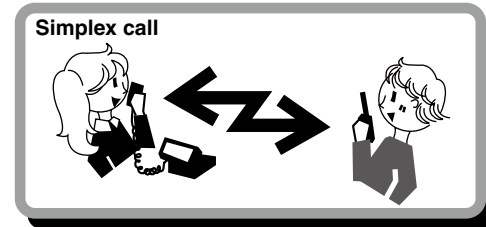

To call another station not using a repeater.

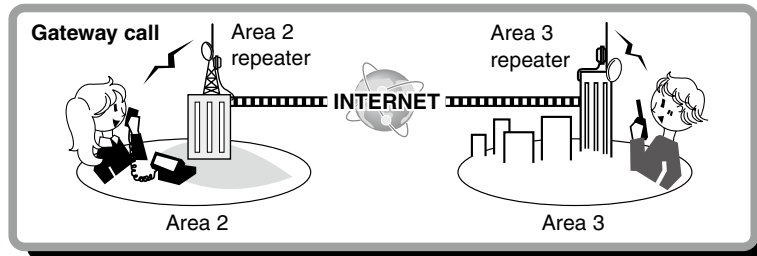

To call through your local area (access) repeater, repeater gateway and the internet to your destination repeater or individual station's last used repeater, using call sign routing.

NOTE:

- Using the repeater list is required to use the DR function. (p. 51)
- Before operating in the duplex mode, be sure to check whether the repeater is busy, or not. If the repeater is busy, wait until it is clear, or ask for a "break" using a method acceptable to your local procedures.
- The transceiver has a Time-Out Timer function for DV operation. The timer limits a continuous transmission. Warning beeps will sound approximately 30 seconds before time-out and then again immediately before time-out.

■ Enter your call sign into the transceiver

You can enter up to six MY call signs, in [MY1] through [MY6].
Example: Enter "JA3YUA" as your own call sign into the MY call sign memory [MY1].

1. Displays the MY Call Sign edit screen

- ① Touch [MENU].
- ② Touch [My Call Sign].
(My Station > My Call Sign)
 - If the item is not displayed, touch [▲] or [▼] one or more times to select the page.



- ③ Touch the MY call sign memory channel "1" ([MY1]) for 1 second.



- ④ Touch "Edit."
 - Opens the "MY CALL SIGN (MY*)" edit screen.
 - The channel number selected in step ③ is displayed on '*'.
 - A cursor appears and blinks.



2. Enter the call sign

- ⑤ Touch the desired keypad to select the first digit.
(Example: J).
 - A to Z, 0 to 9, / and (Space) are selectable.
 - Touch "ab↔12" to toggle between the Alphabet input and Number input modes.
 - Touch [CLR] to delete the selected character, symbol or number.
 - Touch "SPACE" to input a space.



- ⑥ Touch [←] to move the cursor backwards, or touch [→] to move the cursor forwards.
- ⑦ Repeat steps ⑤ and ⑥ to enter your call sign of up to 8 characters, including spaces.

(Example: First J, then A, then 3, then Y, then U, then A)

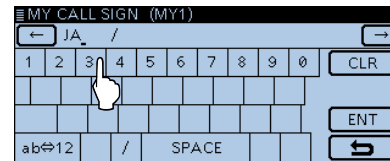

To enter '3:'

/// **NOTE:** Your call sign must match the call sign you registered. (p. 27)

4 D-STAR OPERATION

- Enter your call sign into the transceiver (Continued)

3. Save the call sign

- ⑧ Touch [ENT].
- Saves the entered call sign and returns to the “MY CALL SIGN” screen.
 - See “Convenient” below if you want to enter a note.

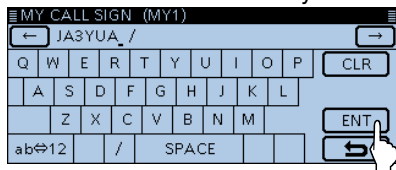

- ⑨ Touch the entered call sign.
- Sets the call sign to be used as MY call sign.

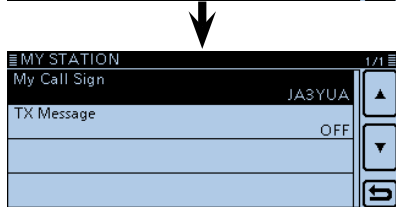
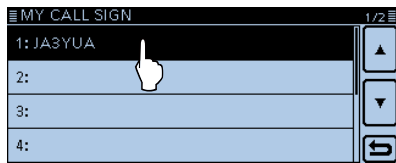

- ⑩ Touch [MENU].
- Closes the “MY CALL SIGN” screen.

Keys used for entry

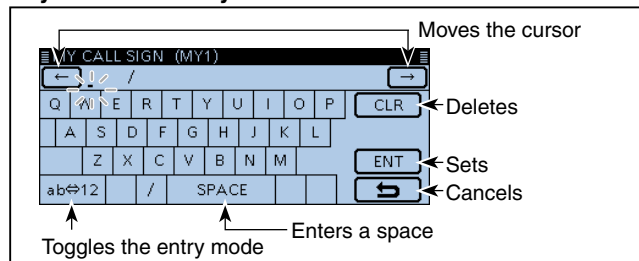

NOTE: The MY Call sign in the instructions is ONLY an example that is used in explanations. You MUST enter your own call sign, the one that was assigned to you and is on your license.

✓ Convenient!

If desired, enter a note of up to 4 characters, such as the model of the transceiver, name, area name, and so on, after your call sign.

- ① Touch [→] one or more times until the cursor moves to the right of the “/”.

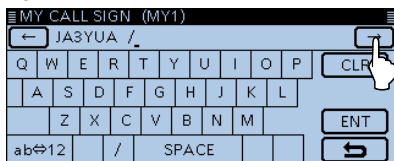

- ② Repeat steps ⑤ and ⑥ on the page 24 to enter a 4 character note.

(Example: 5100)

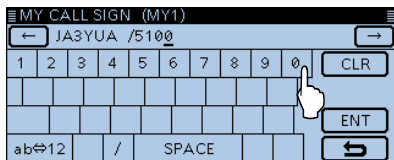

4 D-STAR OPERATION

■ Register your call sign at a gateway repeater

To use the Internet, you must register your call sign with a repeater that has a gateway, usually one near your home location.

■ About the registration process described:

This section describes the call sign registration process at a repeater that is connected to the US Trust server.

There are other systems as well, and they have their own registration process. For information on how to register on one of them, contact the administrator of a repeater that uses the alternate system.

If needed, ask the gateway repeater administrator for call sign registration instructions.

1. Access the call sign registration screen

- ① Access the following URL to find the gateway repeater closest to you.
<http://www.dstarusers.org/repeaters.php>
- ② Click the call sign of the repeater that you want to register to.
- ③ Click the “Gateway Registration URL:” link address.
- ④ The “D-STAR Gateway System” screen appears.
Click [Register] to start the New User registration.

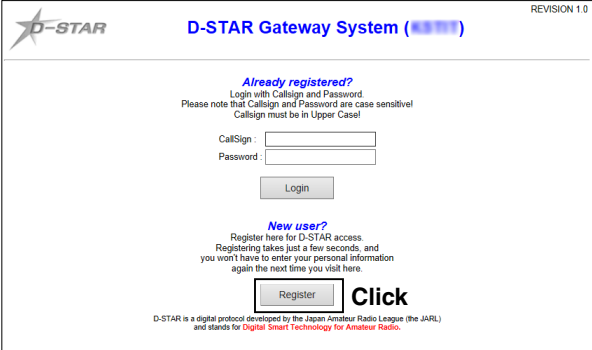

D-STAR D-STAR Gateway System (日本語) REVISION 1.0

Already registered?
Login with Callsign and Password.
Please note that Callsign and Password are case sensitive
Callsign must be in Upper Case!

CallSign :
Password :

Login

New user?
Register here for D-STAR access.
Registering takes just a few seconds, and
you won't have to enter your personal information
again the next time you visit here.

Register **Click**

D-STAR is a digital protocol developed by the Japan Amateur Radio League (the JARL) and stands for Digital Smart Technology for Amateur Radio.

2. Register your call sign

- ⑤ Follow the registration instructions found there.
- ⑥ When you receive a notification from the administrator, your call sign registration has been approved.

/// **NOTE:** It may take a few days for the administrator to approve you.

3. Register your personal information

- ⑦ After your registration is approved, log in your personal account with your registered call sign and password.

D-STAR D-STAR Gateway System (REVISION 1.0)

Already registered?
Login with Callsign and Password.
Please note that Callsign and Password are case sensitive!
Callsign must be in Upper Case!

CallSign :
Password :

Click

New user?
Register here for D-STAR access.
Registering takes just a few seconds, and you won't have to enter your personal information again the next time you visit here.

D-STAR is a digital protocol developed by the Japan Amateur Radio League (the JARL) and stands for **D**igital **S**mart **T**echnology for **A**mateur **R**adio.

4. Register your D-Star equipment

- ⑧ Register your D-STAR equipment information.
Ask the gateway repeater administrator for details.
- ⑨ When your registration is complete, log out of your personal account, and start using the D-STAR network.

/// **NOTE:** You must register your D-STAR equipment **BEFORE** you can make calls through the gateway.

4 D-STAR OPERATION

■ Making a Simplex call

You can make a transceiver to transceiver call (through no repeater) in the DR screen.

NOTE: Depending on the transceiver's version, the frequencies may be different. Check for acceptable frequencies for your operating area.

✓ What is a Simplex Call??

A simplex call is a direct call to another station, not using a repeater.

Example: Making a simplex call on 433.450 MHz.

1. "FROM" (Simplex channel) setting

- ① Touch [DR].
- ② Check whether or not "FROM" is selected.
 - If "FROM" is not selected, touch the "FROM" field.
- ③ Touch the "FROM" field.
 - Opens the "FROM SELECT" screen.

"FROM" is selected.

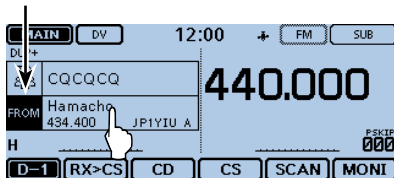

- ④ Touch "Repeater List."
 - Opens the "REPEATER GROUP" screen.

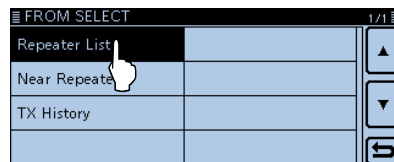

- ⑤ Touch "Simplex."

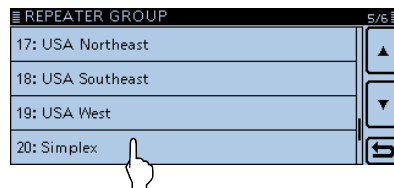

- ⑥ Touch a desired frequency. (Example: 433.450)
 - Returns to the DR screen, and the selected frequency is displayed in "FROM."
 - "CQCQCQ" is displayed in "TO."
 - If a station call sign is set in "TO," select "Local CQ" in the "TO SELECT" screen to set "CQCQCQ" in "TO."

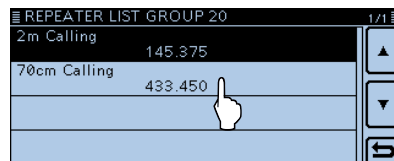

2. Hold down [PTT] to transmit

- The LED1 on the microphone lights red.

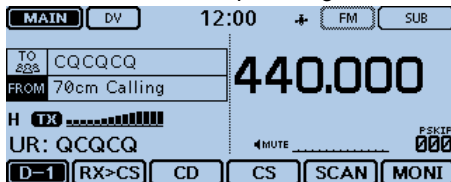

For your reference:

The simplex frequencies can be changed in the MENU screen.

(DV memory > Repeater List > Repeater group > **Simplex**)

When you make a simplex call in the VFO mode, the LCD changes, as shown below.

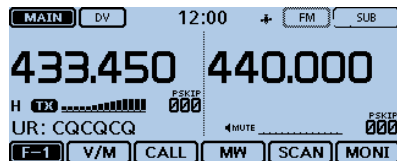

While transmitting in the DV mode

4 D-STAR OPERATION

■ Accessing repeaters

This section describes how to check whether or not you can access your local area repeater (Access repeater), and if your signal is successfully sent to a destination repeater.

▨ If your call sign (MY) has not been set, or your call sign and equipment have not been registered at a D-STAR repeater, see pages 24 to 28.

1. Select your Access repeater (“FROM”)

- ① Touch [DR].
- ② Check whether or not “FROM” is selected.
 - If “FROM” is not selected, touch the “FROM” field.
- ③ Touch the “FROM” field.
 - Opens the “FROM SELECT” screen.

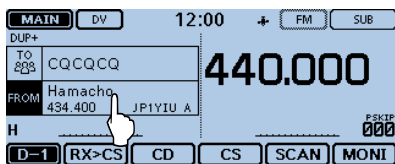

- ④ Touch “Repeater List.”
 - Opens the “REPEATER GROUP” screen.

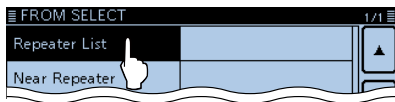

- ⑤ Touch the repeater group where your access repeater is listed. (Example: “11: Japan”)

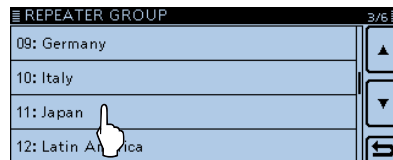

- ⑥ Touch your access repeater. (Example: “Hirano”)
 - Returns to the DR screen, and the selected repeater name is displayed in “FROM.”

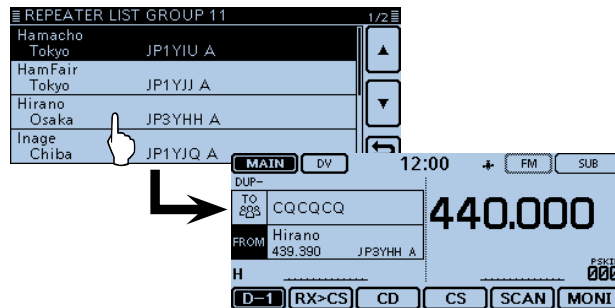

▨ Even if you select just the repeater name, the repeater call sign, its frequency, duplex setting, frequency offset and Gateway call sign are automatically set.

2. Select the Destination repeater (“TO”)

- ⑦ Touch the “TO” field.
 - Check whether “TO” is selected.
- ⑧ Touch the “TO” field again.
 - Opens the “TO SELECT” screen.

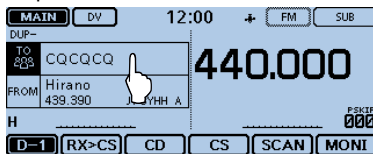

- ⑨ Touch “Gateway CQ.”
 - Opens the “REPEATER GROUP” screen.
- ⑩ Touch the repeater group where your destination repeater is listed. (Example: “11: Japan”)
- ⑪ Touch your destination repeater. (Example: “Hamacho”)
 - Returns to the DR screen, and the selected repeater name is displayed in “TO.”

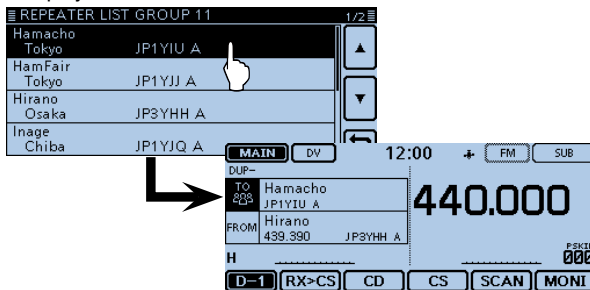

3. Check whether you can access the repeater

- ⑫ Hold down [PTT] for approximately 1 second to access the repeater.

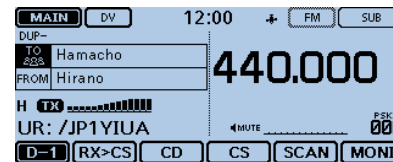

- ⑬ If you get a reply call, or “UR?” appears on the LCD within 3 seconds, your signal reached your access repeater and your call was successfully sent from your destination repeater.

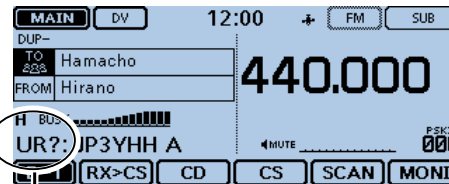

Successfully sent!

UR?:

NOTE: See page 43 for status indications after a repeater system reply is received.

4 D-STAR OPERATION

■ Using the RX history

When a DV call is received, the call signs of the caller, the called station and the called station's access repeater are stored in the RX history file.

Up to 50 calls can be stored.

This section describes how to view the RX history screen and how to save the call sign to memory.

When receiving a call from "JM1ZLK."

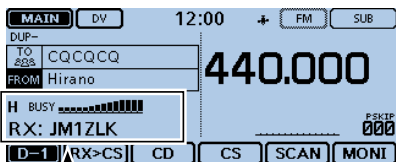

The S-meter appears and the caller's call sign is displayed.

1. To display a received call sign

- ① Touch the Function group icon one or more times.
 - Selects the D-1 menu.
- ② Touch [CD].
 - Opens the "RX HISTORY" screen.
 - Touch [▲] or [▼] one or more times to select other RX history memories.
 - The first page of the "RX HISTORY" screen displays the latest RX record of the MAIN band. The second page or later displays the record according to the received date and time, regardless of the band it was received on.

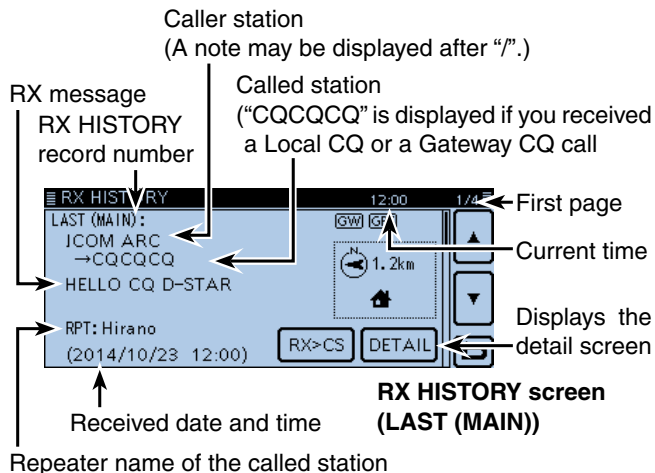

2. Save the destination call sign into your call sign memory from RX History

- ③ Touch [▲] or [▼] one or more times to select the RX HISTORY record with the call sign that you want to save to memory.

- ④ Touch [DETAIL].



- ⑤ Touch [QUICK].

- ⑥ Touch "Add To Your Memory."



- ⑦ Touch the call sign that you want to save. (Example: "JM1ZLK")

/// The display opens the "YOUR CALL SIGN EDIT" screen, and the call sign is automatically set.

- ⑧ Touch "NAME."
 - Opens the "NAME" screen.
 - Enter a name of up to 16 characters, including spaces. (Example: TOM)



- ⑨ Touch [ENT].
 - Returns to the "YOUR CALL SIGN EDIT" screen.

- ⑩ Touch "<<Add Write>>."
 - Opens the "Add write?" window.



- ⑪ Touch [YES].
 - Returns to the "RX HISTORY" screen.

4 D-STAR OPERATION

■ Capturing a call sign

After you receive a repeater's signal, the calling station's call sign can be captured by touching the Call Sign Capture key ([RX>CS]) for 1 second. Then you can quickly and easily reply to the call.

✓ What is the Call Sign Capture key??

Touching the Call Sign Capture key for 1 second sets the last received station call sign as a temporary destination, and makes replying quick and easy.

While receiving

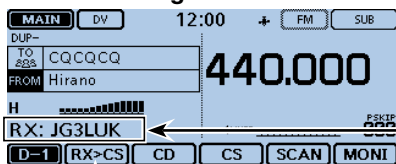

Call Sign Capture key

When receiving a call from "JG3LUK."

1. Set the received call sign to the destination

- ① Touch the Function group icon one or more times.

- Selects the D-1 menu.

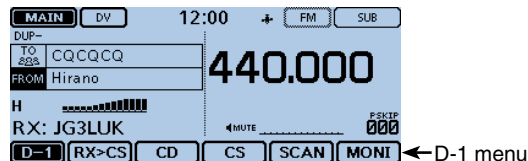

- ② Touch [RX>CS] for 1 second.

- Beep sounds when touched.

- After 1 second, two beeps sound, and the station call sign is announced.

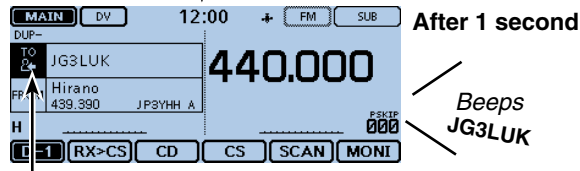
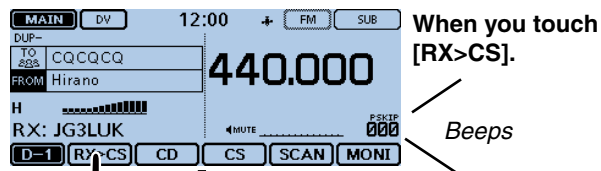

Blinks after selecting a call sign.

NOTE:

- After touching [RX>CS], you can select another call sign in the RX history.
- When a received signal is weak or DR scanning, the call sign may not be correctly received. In that case, you cannot capture a call sign.

2. Hold down [PTT] to transmit

- The LED1 on the microphone lights red.

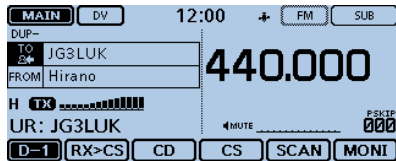

③ Touch [RX>CS].

- Returns to the previous call sign setting.

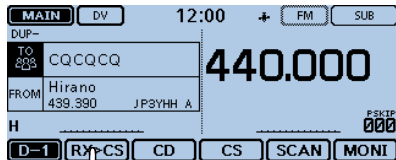

Returns to the previous screen

4 D-STAR OPERATION

■ Making a Local area call

A Local area call can be made when “Local CQ” is used to set “CQCQCQ” in “TO” (Destination).

✓ What is a Local Area Call??

To call through your local area (access) repeater.

1. Set “FROM” (Access repeater)

- ① Touch [DR].
- ② Check whether or not “FROM” is selected.
 - If “FROM” is not selected, touch the “FROM” field.
- ③ Touch the “FROM” field.
 - Opens the “FROM SELECT” screen.

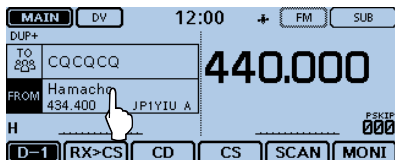

- ④ Touch “Repeater List.”
 - Opens the “REPEATER GROUP” screen.

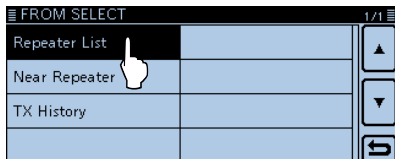

- ⑤ Touch the repeater group where your access repeater is listed. (Example: “11: Japan”)

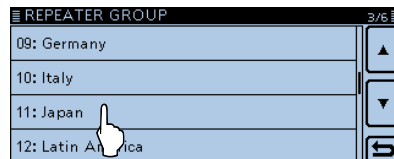

- ⑥ Touch your access repeater. (Example: “Hirano”)
 - Returns to the DR screen, and the selected repeater name is displayed in “FROM.”

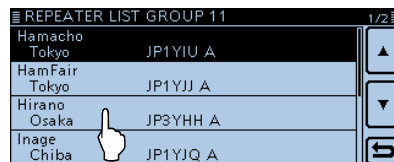

2. Set "TO" (Destination)

- ⑦ Touch the "TO" field.
 - Check whether "TO" is selected.
- ⑧ Touch the "TO" field again.
 - Opens the "TO SELECT" screen.

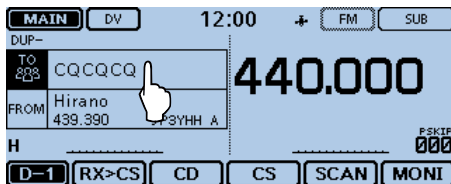

- ⑨ Touch "Local CQ."
 - Returns to the DR screen, and "CQCQCQ" is displayed in "TO."

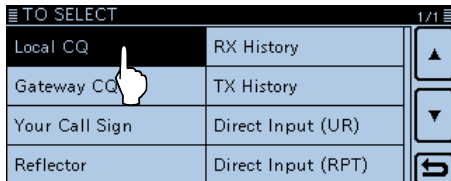

3. Hold down [PTT] to transmit

- The LED1 on the microphone lights red.

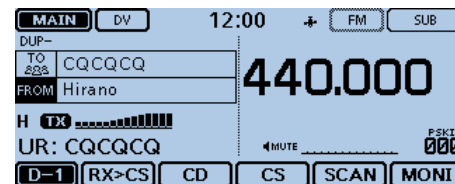

For your reference:

The Local CQ call is used to call anyone, but you can call a specific station by simply saying their call sign.

4 D-STAR OPERATION

■ Making a Gateway Repeater call

A Gateway call can be made when a destination repeater is selected in "TO" (Destination).

✓ What is a Gateway Repeater Call??

To call through your local area (access) repeater, repeater gateway, and the Internet to your desired destination repeater.

1. Set "FROM" (Access repeater)

- ① Touch [DR].
- ② Check whether or not "FROM" is selected.
 - If "FROM" is not selected, touch the "FROM" field.
- ③ Touch the "FROM" field.
 - Opens the "FROM SELECT" screen.

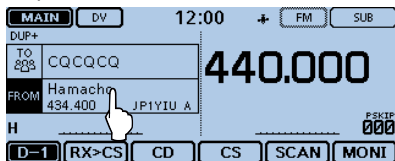

- ④ Touch "Repeater List."
 - Opens the "REPEATER GROUP" screen.

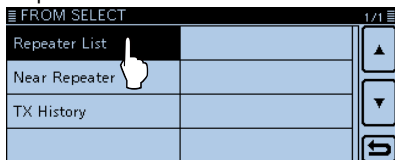

- ⑤ Touch the repeater group where your access repeater is listed. (Example: "11: Japan")

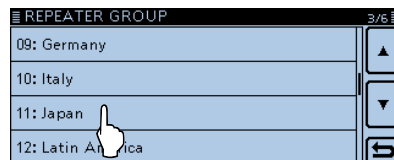

- ⑥ Touch your access repeater. (Example: "Hirano")
 - Returns to the DR screen, and the selected repeater name is displayed in "FROM."

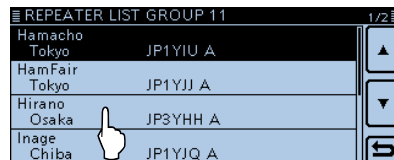

2. Set "TO" (Destination)

- ⑦ Touch the "TO" field.
 - Check whether "TO" is selected.
- ⑧ Touch the "TO" field again.
 - Opens the "TO SELECT" screen.

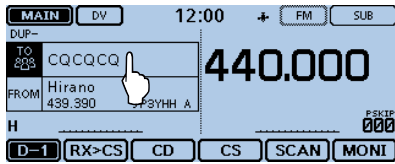

- ⑨ Touch "Gateway CQ."
 - Opens the "REPEATER GROUP" screen.

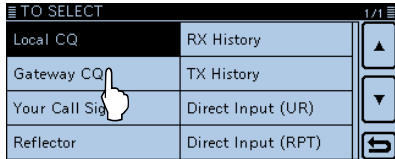

- ⑩ Touch the repeater group where your desired destination repeater is listed. (Example: "11: Japan")

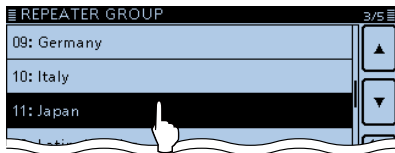

- ⑪ Touch your destination repeater.
 - (Example: "Hamacho")
 - Returns to the DR screen, and the selected repeater name is displayed in "TO."

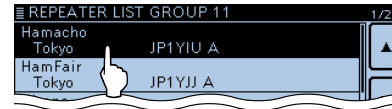

3. Hold down [PTT] to transmit

- The LED1 on the microphone lights red.

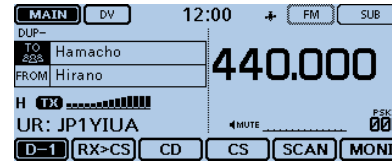

For your reference:

The Gateway CQ call is used to call any repeater, but you can call a specific station by simply saying their call sign.

4 D-STAR OPERATION

■ Calling an individual station

You can make a call to an individual station when the station call sign is selected in “TO” (Destination).

When you call an individual station call sign through a gateway, your call is automatically sent to the last repeater that the station accessed. So, even if you don't know where the station is, you can make a call using call sign routing.

1. Set “FROM” (Access repeater)

- ① Touch [DR].
- ② Check whether or not “FROM” is selected.
 - If “FROM” is not selected, touch the “FROM” field.
- ③ Touch the “FROM” field.
 - Opens the “FROM SELECT” screen.

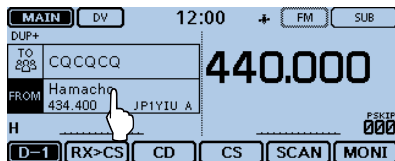

- ④ Touch “Repeater List.”
 - Opens the “REPEATER GROUP” screen.

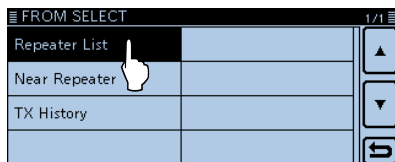

- ⑤ Touch the repeater group where your access repeater is listed. (Example: “11: Japan”)

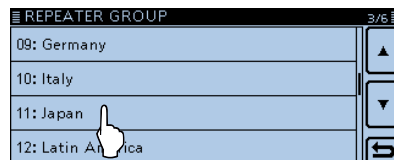

- ⑥ Touch your access repeater. (Example: “Hirano”)
 - Returns to the DR screen, and the selected repeater name is displayed in “FROM.”

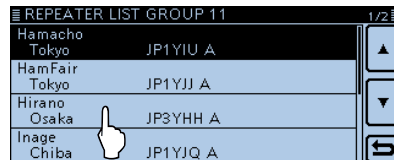

2. Set "TO" (Destination)

- ⑦ Touch the "TO" field.
 - Check whether "TO" is selected.
- ⑧ Touch the "TO" field again.
 - Opens the "TO SELECT" screen.

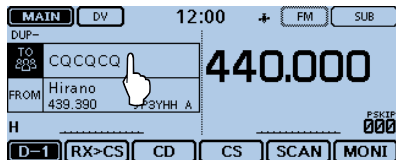

- ⑨ Touch "Your Call Sign."
 - Opens the "YOUR CALL SIGN" screen.

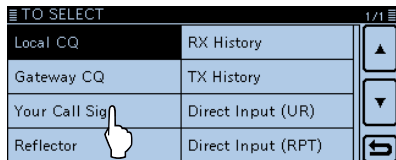

- ⑩ Touch the destination station. (Example: "TOM")
 - Returns to the DR screen, and the selected station name is displayed in "TO."

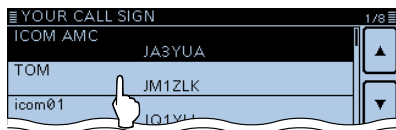

3. Hold down [PTT] to transmit

- The LED1 on the microphone lights red.

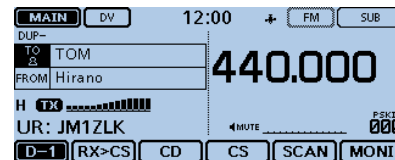

4 D-STAR OPERATION

■ Troubleshooting

To communicate through the repeater, your signal must access to the repeater. When your signal accesses your local repeater, but it is not sent to the destination repeater, the repeater replies with a status message.

PROBLEM	POSSIBLE CAUSE	SOLUTION	REF.
After your call, the repeater does not return a status reply.	<ul style="list-style-type: none"> • The repeater setting is wrong. • Your transmission did not reach the repeater. 	<ul style="list-style-type: none"> • Select the correct repeater. • Correct the repeater frequency, frequency offset, or duplex setting. • Wait until you are closer to the repeater and try again. • Try to access another repeater. 	p. 31 — —
After your call, the repeater replies 'UR?' and its call sign.	<ul style="list-style-type: none"> • The call was successfully sent, but no station immediately replied. 	<ul style="list-style-type: none"> • Wait for a while, and try again. 	—
After your call, the repeater replies 'RX' or 'RPT?' and the access repeater's call sign.	<ul style="list-style-type: none"> • Your call sign (MY) has not been set. • Your call sign (MY) has not been registered on a gateway repeater, or the registered contents do not match your transceiver's setting. 	<ul style="list-style-type: none"> • Set your call sign (MY). • Register your call sign (MY) on a D-STAR repeater, or confirm the registration of the call sign. 	p. 24 p. 27

PROBLEM	POSSIBLE CAUSE	SOLUTION	REF.
After your call, the repeater replies 'RPT?' and call sign of the destination repeater.	<ul style="list-style-type: none"> The repeater cannot connect to the destination repeater. The repeater is busy. 	<ul style="list-style-type: none"> Check the repeater setting. Wait for a while, and try it again. 	— —
After your call, the access repeater replies 'RPT?' and its call sign.	<ul style="list-style-type: none"> The call sign of the destination repeater is wrong. 	<ul style="list-style-type: none"> Correctly set the destination repeater call sign. 	—
Even holding down [DR], the DR screen will not appear.	<ul style="list-style-type: none"> There is no repeater list in your radio. 	<ul style="list-style-type: none"> Reload the repeater list using the SD card. Enter the Repeater list data directly into the transceiver. 	p. 51 Section 7 of the Full Manual
Even holding down [RX>CS], the received call sign will not set to the destination call sign.	<ul style="list-style-type: none"> The call sign has not been correctly received. When a received signal is weak, or a signal is received during scanning, the call sign may not be received correctly. In that case, "-----" appears and error beeps sound, and a reply call cannot be made. 	<ul style="list-style-type: none"> Try it again, after the transceiver has correctly received the call sign. 	—
A Local area call can be made, but the Gateway call or destination station call cannot be made.	<ul style="list-style-type: none"> MY call sign has not been registered at a D-STAR repeater. 	<ul style="list-style-type: none"> Register your call sign (MY) on a D-STAR repeater, or confirm the registration of the call sign. 	p. 27
<p>"L" appears on the LCD, and the received audio is interrupted.</p> 	<ul style="list-style-type: none"> While receiving through the internet, some packets may be lost due to a network error (poor data throughput performance). 	<ul style="list-style-type: none"> Wait a while, and try it again. When the transceiver receives corrupted data, and misidentifies it as packet loss, "L" is displayed, even if it is a Local area call. 	—
"DV" and "FM" icons alternately blink.	<ul style="list-style-type: none"> While in the DV mode, an FM signal is received. 	<ul style="list-style-type: none"> Wait a while, and try it again. 	Section 7 of the Full Manual

4 D-STAR OPERATION

■ Reflector operation

◇ What is the reflector?

A reflector is a special server connected to the internet and running a version of dplus software. If the dplus software is installed on your access repeater, it provides various functions including gateway and reflector linking capabilities (It is known as the D-STAR reflector system). The D-STAR reflector system enables a number of D-STAR repeaters around the world to link to a reflector. This means that when you transmit through a D-STAR repeater linked to a reflector, your voice can be heard on other repeaters linked to the reflector, and you can hear other stations that are connected to the reflector.

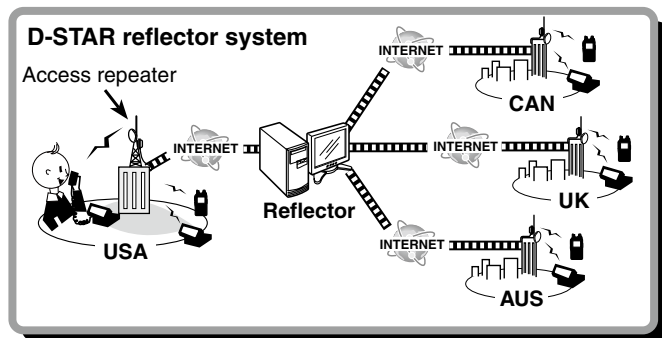

◇ Linking to a reflector

If your repeater is not currently linked to a reflector, or you want to change to another reflector, you can do so following the steps below. Before linking to another reflector, be sure to unlink the current reflector. (p. 48)

Direct inputting

Example: Directly enter “REF010BL.”

- ① Touch [DR].
- ② Check whether or not “TO” is selected.
 - If “TO” is not selected, touch the “TO” field.
- ③ Touch the “TO” field.
 - Opens the “TO SELECT” screen.

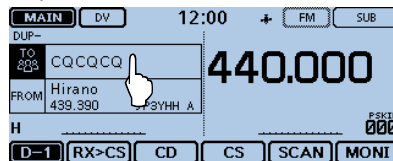

- ④ Touch “Reflector.”
 - Opens the “REFLECTOR” screen.

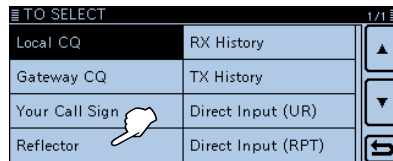

- ⑤ Touch “Link to Reflector.”
- ⑥ Touch “Direct Input.”
- ⑦ Touch [+] or [-] one or more times to select the reflector number. (Example: 010)
 - Touch [↵] to cancel, and then return to the previous screen.

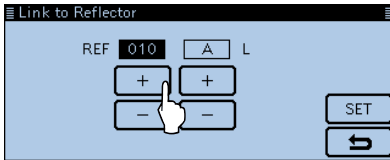

- ⑧ Touch [+] or [-] one or more times on the right-end box to select the module letter. (Example: B)
- ⑨ Touch [SET].
 - The transceiver returns to the DR screen.
 - “Link to Reflector” and “REF010BL” are displayed in “TO.”

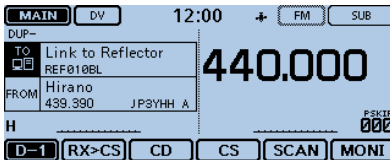

- ⑩ Hold down [PTT] to link to the reflector.
 - The LED1 on the microphone lights red.

Using the TX History

The TX History stores the up to 5 reflectors that your access repeater linked before.

Example: Select the “REF002AL” in the TX History.

- ① Touch [DR].
- ② Check whether or not “TO” is selected.
 - If “TO” is not selected, touch the “TO” field.
- ③ Touch the “TO” field.
 - Opens the “TO SELECT” screen.

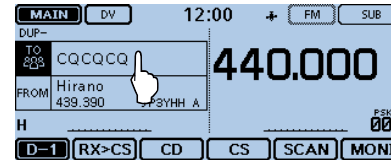

- ④ Touch “Reflector.”
 - Opens the “REFLECTOR” screen.

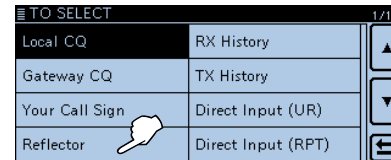

4 D-STAR OPERATION

■ Reflector operation

◇ Linking to a reflector (Continued)

⑤ Touch “Link to Reflector.”

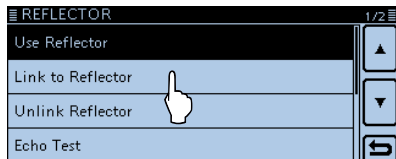

⑥ Touch the reflector that you want to link to. (Example: “REF002AL”)

- The transceiver returns to the DR screen.
- “Link to Reflector” and “REF002AL” are displayed in “TO.”

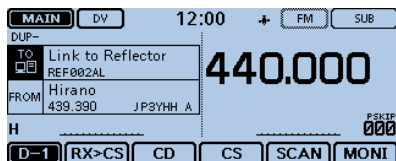
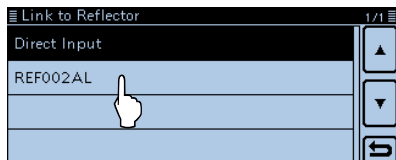

⑩ Hold down [PTT] to link to the reflector. • The LED1 on the microphone lights red.

◇ Using a reflector

- ① Touch [DR].
- ② Check whether or not “TO” is selected.
 - If “TO” is not selected, touch the “TO” field.
- ③ Touch the “TO” field.
 - Opens the “TO SELECT” screen.
- ④ Touch “Reflector.”
 - Opens the “REFLECTOR” screen.
- ⑤ Touch “Use Reflector.”
 - The transceiver returns to the DR screen.
 - “Use Reflector” and “CQCQCQ” are displayed in “TO.”

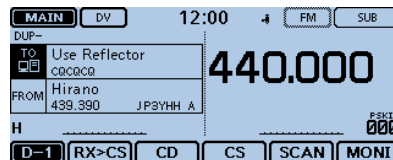
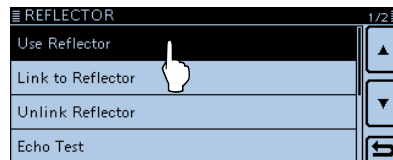

⑥ Hold down [PTT] to transmit. • The LED1 on the microphone lights red.

◇ Unlinking a reflector

Before linking to another reflector, be sure to unlink the current reflector.

- ① Touch [DR].
- ② Check whether or not "TO" is selected.
 - If "TO" is not selected, touch the "TO" field.
- ③ Touch the "TO" field.
 - Opens the "TO SELECT" screen.

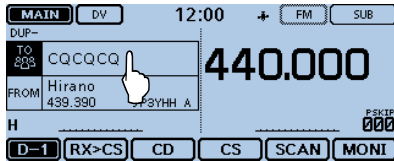

- ④ Touch "Reflector."

 - Opens the "REFLECTOR" screen.

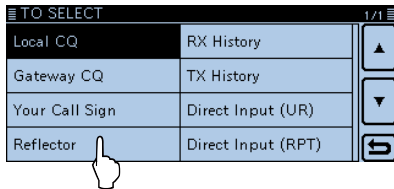

- ⑤ Touch "Unlink Reflector."
 - The transceiver returns to the DR screen.
 - "Unlink Reflector" and "U" are displayed in "TO."

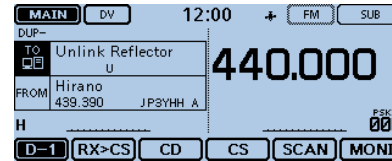
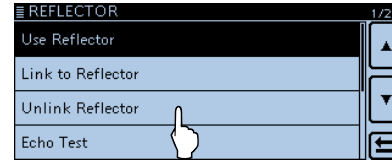

- ⑥ Hold down [PTT] to unlink the reflector.
 - The LED1 on the microphone lights red.

4 D-STAR OPERATION

■ Reflector operation (Continued)

◇ Reflector Echo Testing

You can transmit a short message, and after releasing [PTT], your message will be played back. It is a useful check of how well your signal is getting into the repeater, and you can use it to verify that your repeater is operating normally.

- ① Touch [DR].
- ② Check whether or not "TO" is selected.
 - If "TO" is not selected, touch the "TO" field.
- ③ Touch the "TO" field.
 - Opens the "TO SELECT" screen.

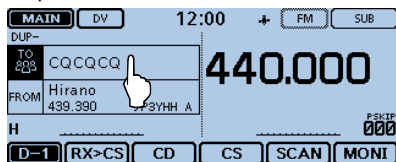

- ④ Touch "Reflector."
 - Opens the "REFLECTOR" screen.

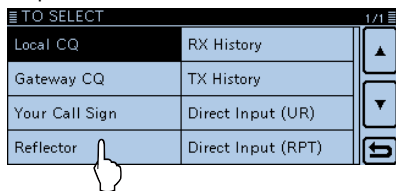

- ⑤ Touch "Echo Test."
 - The transceiver returns to the DR screen.
 - "Echo Test" and "E" are displayed in "TO."

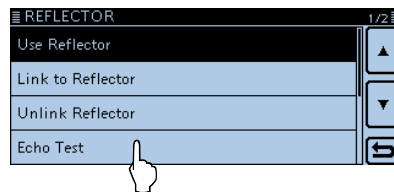

- ⑥ Hold down [PTT] and speak into the microphone.
 - The LED1 on the microphone lights red.
- ⑦ Release [PTT] to hear your message.



◇ Requesting repeater information

When you send the repeater information command, an ID message is sent back.

- ① Touch [DR].
- ② Check whether or not “TO” is selected.
 - If “TO” is not selected, touch the “TO” field.
- ③ Touch the “TO” field.
 - Opens the “TO SELECT” screen.

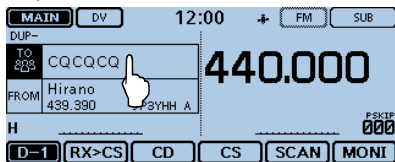

- ④ Touch “Reflector.”
 - Opens the “REFLECTOR” screen.

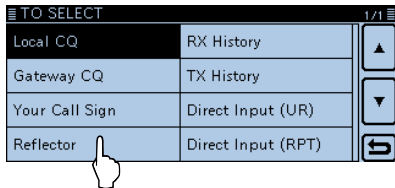

- ⑤ Touch [▼] to select the next page.
- ⑥ Touch “Repeater Information.”
 - The transceiver returns to the DR screen.
 - “Repeater Information” and “I” are displayed in “TO.”

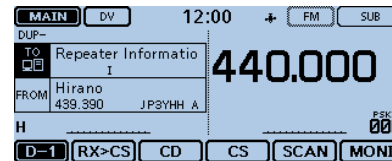
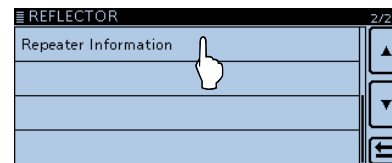

- ⑦ Hold down [PTT] to send the repeater information command.
 - The LED1 on the microphone lights red.
- ⑧ Release [PTT] to hear the repeater ID message.

4 D-STAR OPERATION

■ Updating the repeater list

For easy operation, the repeater list is preloaded into your transceiver.

This section describes how to manually update the repeater list using an SD card.

You can download the latest repeater list from the Icom website.

1. Downloading the latest repeater list

- 1 Access the following URL to download the latest data.
<https://www.icomjapan.com/support/>

- The latest repeater list (CSV: Comma Separated Values file) and settings file (ICF file) are contained in the downloaded ZIP file.

File Name: 5100_USA_Rpt_yymmdd.zip (Example)

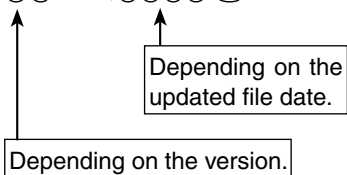

ID-5100A/E's latest repeater list and setting file are uploaded to "Repeater List & Setting Data(Version 20*****)" on the Icom website screen.

- The displayed contents may differ.

Firmware / Software

Search by genre Search by Model name

Please fill the model name or part of the model name, and click the "Search" button

ID-5100

Search

Type	Model Name	ASC / DESC	Version	last update
Repeater List & Setting Data	ID-5100A		20	20/11/17
Firmware	ID-5100A/ID-5100E		Release	20/11/17
Cleaning software	ID-5100A/ID-5100E		Revision	20/11/17
Repeater List & Setting Data	ID-5100E		20	20/11/17

- 2 Unzip the ZIP file that you downloaded from the Icom website.
The "5100_USA_Rpt_yymmdd" (Example) folder will be created.

2. Inserting the SD card into a PC

- 3 Insert the SD card into the SD card drive on your PC.
 - Icom recommends that you format all SD cards to be used with the transceiver, even preformatted SD cards for PCs or other uses. (p. 56)

See page 56 and 58 for details on inserting and removing the SD card.

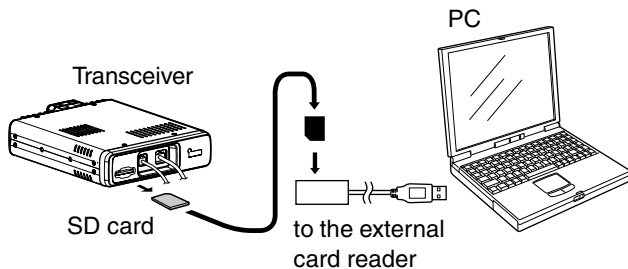

3. Copying the latest repeater list to the SD card

- 4 Double-click the “5100_USA_Rpt_yymmdd” (Example) folder created in the same place where the downloaded file is saved.
- 5 Copy the CSV file (Example: “5100_USA_Rpt_yymmdd.csv”) in the folder to [RptList] of the SD card.
[ID-5100] > [CSV] > [RptList]

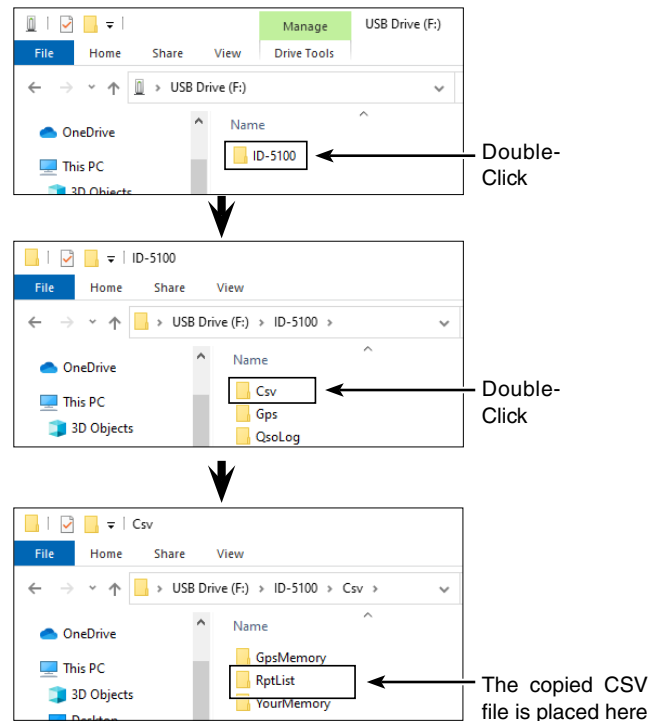

Continued on the next page

4 D-STAR OPERATION

■ Updating the repeater list (Continued)

4. Inserting the SD card

- 6 Remove the SD card from your PC, and insert it into the transceiver's slot.

See page 56 for details on inserting the SD card into the transceiver.

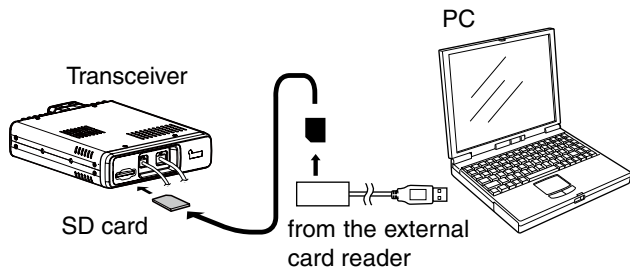

▨ Icom recommends that you save the current data before loading other data into the transceiver.

5. Updating the repeater list

- 7 Touch [MENU].
- 8 Touch [Repeater list].
(SD Card > Import/Export > Import > **Repeater list**)
 - If the item is not displayed, touch [▲] or [▼] one or more times to select another page.

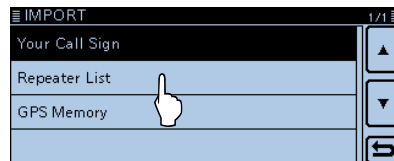

- 9 Touch the CSV file to be loaded.
(Example: "5100_USA_Rpt_yymmdd.csv")
 - The "Keep 'SKIP' settings in Repeater List?" window appears.

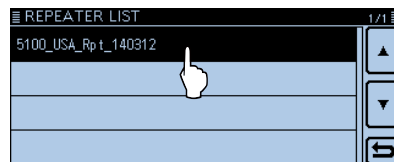

- 10 Touch [YES] or [NO].
- When you touch [YES], the skip settings of the repeater list are retained.
 - When you touch [CANCEL], returns to the “REPEATER LIST” screen.



- 11 When the “Import file?” appears, Touch [YES].
- Starts to import.
 - While importing, “IMPORTING” and a progress bar are displayed.



- 14 After importing ends, “COMPLETED!” appears.
To complete the importing, reboot the transceiver.

For your reference:

If you copy the ICF file to [Setting] of the SD card, the repeater list can be updated with the same procedures. In this case, touch “Load Setting.”

(SD Card > **Load Setting**)

In the LOAD FILE screen, touch “Repeater List Only.”

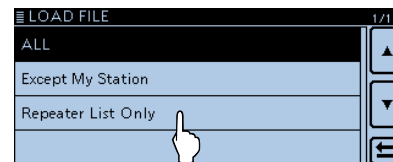

■ About the SD card

The SD and SDHC cards are not available from Icom. Purchase separately.

An SD card of up to 2 GB, or an SDHC of up to 32 GB, can be used with the ID-5100A/E.

Icom has checked the compatibility with the following SD and SDHC cards.

(As of June 2020)

Brand	Type	Memory size
SanDisk®	SD	2 GB
	SDHC	4 GB
		8 GB
		16 GB
		32 GB

- The above list does not guarantee the card's performance.
- Throughout the rest of this document, the SD card and an SDHC card are simply called SD cards.
- Icom recommends that you format all SD cards to be used with the transceiver, even preformatted SD cards for PCs or other uses.



▨ Saving the factory default data is recommended. Insert the card into the transceiver's slot, and then touch [MENU].
 ▨ Touch "SD Card," and then "Save Setting" to save.

NOTE:

- Before using the SD card, read the instructions of the SD card thoroughly.
- If you do any of the following, the SD card data may be corrupted or deleted.
 - You remove the SD card from the transceiver while accessing the SD card.
 - You change the external power supply's voltage while accessing the SD card.
 - You start the vehicle engine while accessing the SD card.
 - You drop, impact or vibrate the SD card.
- Do not touch the contacts of the SD card.
- The transceiver takes a longer time to recognize a high capacity SD card.
- The SD card will get warm if used continuously for a long period of time.
- The SD card has a certain lifetime, so data reading or writing may not be possible after using it for a long time period.
- When reading or writing data is impossible, the SD card's lifetime has ended. In this case, purchase a new one. We recommend you make a backup file of the important data onto your PC.
- Icom will not be responsible for any damage caused by data corruption of an SD card.

■ Inserting the SD card

◇ Inserting the SD card

- ① Turn OFF the transceiver.
- ② Insert the card into the slot until it locks in place, and makes a 'click' sound.
- ③ Turn ON the transceiver.
 - “” is displayed when the SD card is inserted.
 - “” and “” alternately blink while accessing the SD card.

NOTE: Before inserting, be sure to check the card direction. If the card is forcibly or inversely inserted, it will damage the card and/or the slot.

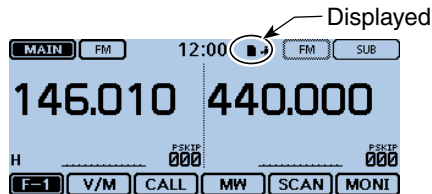
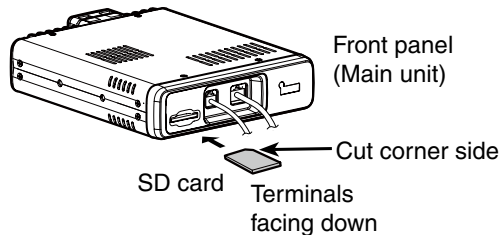

◇ Formatting the SD card

- If you use a brand new SD card, format it by doing the following steps.
- **Formatting a card erases all its data.** Before formatting any used card, back up its data onto your PC.

- ① Turn OFF the transceiver, and then insert the card into the slot.
- ② Turn ON the transceiver.
 - “” appears when the SD card is inserted.
- ③ Touch [MENU].
- ④ Touch “SD Card.”
 - If the item is not displayed, touch [▲] or [▼] one or more times to select the page.
- ⑤ Touch “Format.”
 - The confirmation window “Format OK?” appears.



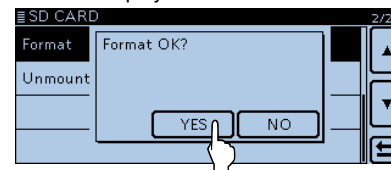

- ⑥ Touch [YES].
 - The formatting starts and the display shows the formatting progress.
 - After formatting ends, the display automatically returns to the screen displayed before the “Format OK?” window.



5 RECORDING A QSO ONTO AN SD CARD

■ Recording a QSO audio

- ① Touch the Function group icon one or more times.
 - When the DR screen is displayed, selects the D-3 menu.
 - While in the VFO, Memory or Call CH mode, displays the F-3 menu.
- ② Touch [REC].
 - The “Recording started” dialog box appears, and voice recording starts.
 - “” is displayed while the transceiver is recording.
 - “” is displayed while the recording is paused.
 - Recording is continuous until you manually stop recording, or the card becomes full.
 - If the recording file’s content reaches 2GB, the transceiver automatically creates a new file, and continues recording.



NOTE:

Once the voice recording starts, it will continue until you stop recording, even if you turn OFF the transceiver.

- ③ Touch the record icon.
 - The “Stop recording?” dialog box appears.

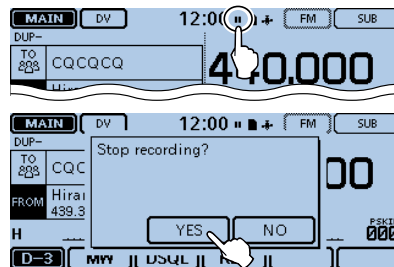

- ④ Touch [YES].
 - The “Recording stopped” dialog box appears, and voice recording stops.

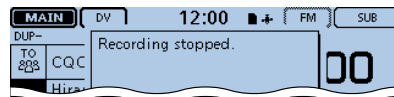

For your reference:

When the PTT Automatic Recording function is set to ON in the MENU screen, the recording automatically starts when [PTT] is pushed.

(Voice Memo > QSO Recorder > Recorder Set > **PTT Auto REC**)

■ Playing recorded audio

- ① Touch [MENU].
- ② Touch “Play Files.”
(Voice Memo > QSO Recorder > **Play Files**)
 - If the item is not displayed, touch [▲] or [▼] one or more times to select the page the item is on.

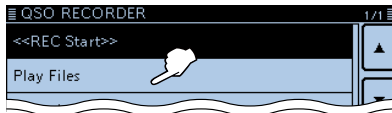

- ③ Touch the folder that contains the file you want to play.
 - The file list is displayed.
 - The folder is named yyyyymmdd (y: year, m: month, d: day.)
- ④ Touch the file that you want to play.
 - The “VOICE PLAYER” screen is displayed, and the file starts to play.
 - See the Full Manual for details.

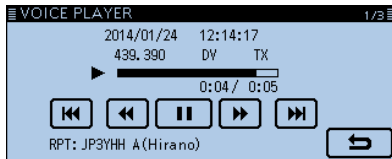

- ⑤ Touch [MENU].
 - Stops the playing, and the “VOICE PLAYER” screen closes.

■ Removing the SD card

◇ Removing the SD card

- ① Turn OFF the power.
- ② Push in the SD card until a click sounds, and then carefully pull it out.

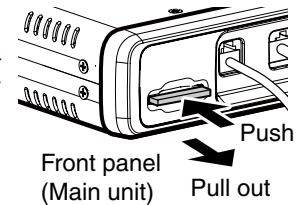

◇ Removing the SD card while the transceiver's power is ON

- ① Touch [MENU].
- ② Touch “SD Card.”
 - If the item is not displayed, touch [▲] or [▼] one or more times to select the page with the item.
- ③ Touch “Unmount.”
 - The confirmation window “Unmount OK?” appears.

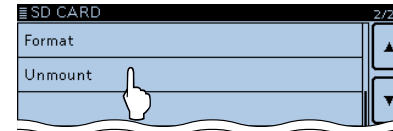

- ④ Touch [YES].
 - When the unmounting is completed, “Unmount is completed.” is displayed, then the display automatically returns to the screen displayed before the “Unmount OK?” window.
- ⑤ Push in the SD card until a click sounds, and then carefully pull it out.

■ GPS operation

The transceiver has a built-in GPS receiver. You can check your current position, and transmit GPS data in the DV mode.

◇ GPS receive setting

Check whether or not the GPS receiver is receiving your position.

The GPS icon blinks when searching for satellites.



The GPS icon stops blinking when the minimum needed number of satellites is found.



- It may take only a few seconds to receive. But depending on the environment, it may take a few minutes. If you have difficulties receiving, we recommend that you try a different location.
- When “GPS Select” item is set to “Manual,” the icon does not appear.
(GPS > GPS Set > GPS Select)

NOTE:

The built-in GPS receiver does not calculate its position if it cannot receive signals from the GPS satellites. Refer to page 82 for details.

■ Checking your GPS position

You can check your current position.

If you transmit while displaying the GPS position screen, the screen closes.

But you can check your current position, RX position, and so on by touching the GPS icon while transmitting.

◇ Displaying Position Data

- ① Touch the GPS icon.

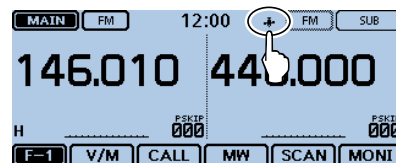

- ② Touch [GPS Position].

- Opens the “GPS POSITION” screen.

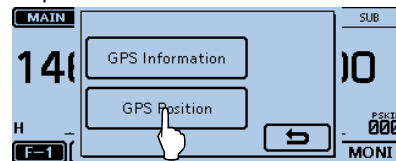

- ③ Touch [▲] or [▼] one or more times.
 - Selects the page.

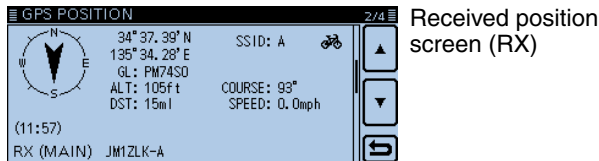
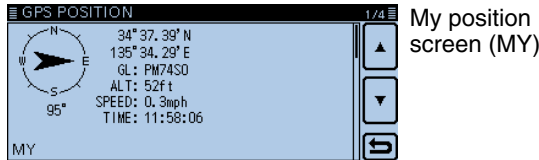

- ④ Touch [↵].
 - Closes the “GPS POSITION” screen.

◇ About the GPS Position screen

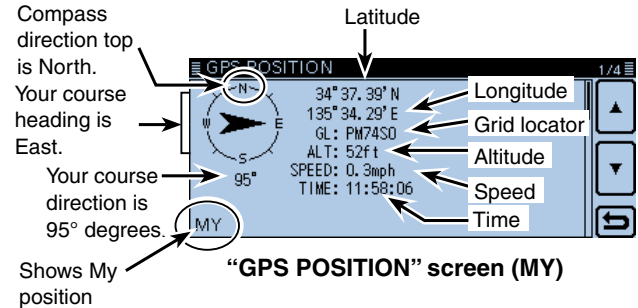

■ Menu item selection

The Menu screen is used to program infrequently changed values or function settings.

In addition to this page, see pages 62 through 78 for details of each item's options and their default value.

NOTE: The Menu system is constructed in a tree structure. You may go to the next tree level, or go back a level, depending on the selected item.

◇ Entering the Menu screen

Example: Set the Auto Power OFF function to "30 min."

- ① Touch [MENU].
- ② Touch [▲] or [▼] one or more times to select the page.
 - If you continuously hold down [▲] or [▼], the items are quickly scrolled.
 - You can select an item by rotating [DIAL].
- ③ Touch "Time Set."

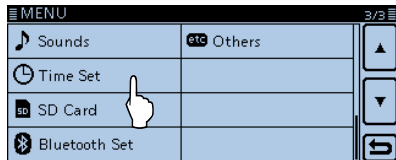

- ④ Touch "Auto Power OFF."
 - To set other item, touch [↵] to go back a tree level.

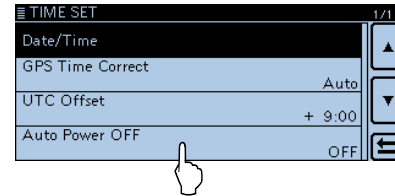

- ⑤ Touch "30min."

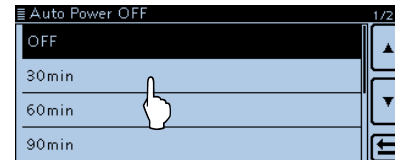

- ⑥ Touch [MENU]
 - Closes the Menu screen.

To return to the default setting:
Touch [QUICK] in step ⑤, and then touch "Default."

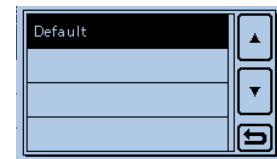

■ Menu items and Default settings

/// **NOTE:** The default settings shown in bold letters below are for the USA version.
 /// The default settings may differ, depending on your transceiver version.

DUP/TONE...	Settings to access repeaters.	
Offset Freq	0.000~ 0.600.00 *1~59.995 MHz	Sets the frequency offset for duplex (repeater) operation.
Repeater Tone	67.0~ 88.5 ~254.1 Hz	Selects a tone frequency used to access the repeaters.
TSQL Freq	67.0~ 88.5 ~254.1 Hz	Selects a tone frequency for the Tone squelch or the pocket beep function.
Tone Burst	OFF or ON	Turns the Tone Burst function ON or OFF. This function is used to suppress the squelch tail noise heard from the transceiver's speaker.
DTCS Code	023 ~754	Selects a DTCS (both encoder/decoder) code for DTCS squelch or the pocket beep function.
DTCS Polarity	Both N , TN-RR, TR-RN or Both R	Selects the DTCS polarity for the DTCS squelch or the pocket beep function.
Digital Code	00 ~99	Selects a digital code for the Digital Code squelch function.
Manage Memory	Manage your Memory or Call channel data.	
Memory CH	ALL , A~Z	Manages for the Memory channels.
Call CH	C0/C1(144):146.010 FM*2 C0/C1(430):440.000 FM*2	Manages for the Call channels.

*1 The default value may differ, depending on the frequency band (selected as the MAIN band before entering the Menu screen) and the transceiver version.

*2 The default value may differ, depending on the transceiver version.

7 MENU SCREEN

■ Menu items and Default settings (Continued)

Scan	Set scan options.	
Pause Timer	2sec~ 10sec ~20sec or HOLD	Selects the scan pause time. When receiving signals, the scan pauses according to the scan pause timer.
Resume Timer	0sec~ 2sec ~5sec or HOLD	Selects the scan resume time from a pause after the received signal disappears.
Temporary Skip Timer	5min , 10min or 15 min	Selects the Temporary Skip Time. When the time is set, specified frequencies are skipped for this period during a scan.
Program Skip	OFF or ON	Turns the Program Skip Scan function ON or OFF for a VFO mode scan.
Bank Link	A: <input checked="" type="checkbox"/> ~Z: <input checked="" type="checkbox"/>	Selects banks to be scanned during a Bank Link Scan.
Program Scan Edge	00~24	Sets the frequency ranges for the program scan.
Program Link		Sets the link function for the program scan edge channels.
	See the Full Manual for details of the preset values.	
Voice Memo	Set the TX/RX voice recording options.	
QSO Recorder		
<<REC Start>>*		Starts recording the received signal audio.
Play Files*	PLAY FILES	Plays or deletes the recorded audio.
Recorder Set		
REC Mode	TX&RX or RX Only	Selects to record the TX audio or not.
RX REC Condition	Always or Squelch Auto	Selects whether or not the squelch status affects the RX voice audio recording.
File Split	OFF or ON	Selects whether or not to automatically create a new file if transmission and reception, or squelch status (open and close) is switched.

* Be sure to insert the SD card into the transceiver before selecting these items.

PTT Auto REC	OFF or ON	Turns the PTT Automatic Recording function ON or OFF.
Player Set		
Skip Time	3sec, 5sec, 10sec or 30sec	Sets the Skip time to rewind or forward the recorded audio when you push the fast-rewind or fast-forward key during playback.
DV Auto Reply*		Records a voice audio to use the Auto Reply function in the DV mode.
Voice TX Set microphone voice recording options.		
Record*	T1~T4	Starts recording the microphone audio.
TX Set		
Repeat Time	1sec~ 5sec ~15sec	Sets the repeat interval. The transceiver repeatedly transmits the recorded voice audio at this interval.
TX Monitor	OFF or ON	The TX Monitor function outputs the TX voice audio from the speaker during voice transmission.
<<TX>>*	T1~T4, Repeat TX	The transceiver transmits the recorded voice audio.
GPS Set GPS options.		
GPS Set		
GPS Select	OFF, Internal GPS , External GPS or Manual	Selects the position data source that the transceiver uses for its position data.
Manual Position		Manually enter your current position.
GPS Out (To DATA Jack)	OFF or ON	Selects to output the GPS information to the [DATA] jack
GPS TX Mode		
OFF		Turns OFF the GPS TX function.
D-PRS		
Unproto Address	API510,DSTAR*	Enters an unproto address, or keep the default.

* Be sure to insert the SD card into the transceiver before selecting these items.

7 MENU SCREEN

■ Menu items and Default settings (Continued)

TX Format		
Position		
Symbol	1:Car, 2:Van, 3:Truck or 4:House QTH (VHF)	Selects a desired D-PRS Symbol to transmit.
SSID	---, (-0), -1~-15 or -A~-Z	Selects the APRS® call sign SSID.
Comment		Enters a comment to transmit.
Time Stamp	OFF, DHM or HMS	Selects a format to transmit the current UTC time as a time stamp.
Altitude	OFF or ON	Turns the altitude transmit option ON or OFF.
Data Extension	OFF, Course/Speed or Power/Height/Gain/Directivity	Selects whether to transmit the course/speed data, power/height/gain/directivity data or not.
Power	0W, 1W, 4W, 9W, 16W, 25W, 36W, 49W, 64W or 81W	Selects the TX power level information to send when using as a base station.
Height	10ft, 20ft, 40ft, 80ft, 160ft, 320ft, 640ft, 1280ft, 2560ft, 5120ft*	Selects the height information to send when using as a base station.
Gain	0dB~9dB	Selects the antenna gain information to send when using as a base station.
Directivity	Omni, 45°NE, 90°E, 135°SE, 180°S, 225°SW, 270°W, 315°NW, 360°N	Selects the antenna directivity information to send when using as a base station.
Object		
Object Name		Enters an object station name to transmit.
Data Type	Live Object, Killed Object	Selects an object station's status to transmit.
Symbol	Radio	Selects an object station's symbol to transmit.
Comment		Enters an object station's comment to transmit.
Position		Sets an object station's position data to transmit.
Data Extension	OFF, Course/Speed or Power/Height/Gain/Directivity	Selects whether to transmit the object station's course/speed data, power/height/gain/directivity data or not.
Course	0°~360°	Sets an object station's course to transmit.
Speed	0mph~1150mph*	Sets an object station's speed to transmit.

* The unit may differ, depending on the "Display Unit" settings. (p. 74)

Power	0W , 1W, 4W, 9W, 16W, 25W, 36W, 49W, 64W or 81W	Selects an object station's TX power level to transmit.
Height	10ft , 20ft, 40ft, 80ft, 160ft, 320ft, 640ft, 1280ft, 2560ft, 5120ft*	Selects the height of the object station to transmit.
Gain	0dB ~9dB	Selects the antenna gain of the object station to transmit.
Directivity	Omni , 45°NE, 90°E, 135°SE, 180°S, 225°SW, 270°W, 315°NW, 360°N	Selects the antenna directivity of the object station to transmit.
SSID	- - - , (-0), -1~-15 or -A~-Z	Selects the APRS® call sign SSID for the object station.
Time Stamp	DHM or HMS	Selects a format to transmit the current UTC time as a time stamp.
Item		
Item Name		Enters an item station name to transmit.
Data Type	Live Item , Killed Item	Selects an item station's status to transmit.
Symbol	Radio	Selects an item station's symbol to transmit.
Comment		Enters an item station's comment to transmit.
Position		Sets an item station's position data to transmit.
Data Extension	OFF , Course/Speed or Power/Height/Gain/Directivity	Selects whether to transmit the item station's course/speed data, power/height/gain/directivity data or not.
Course	0° ~360°	Sets an item station's course to transmit.
Speed	0mph ~1150mph*	Sets an item station's speed to transmit.
Power	0W , 1W, 4W, 9W, 16W, 25W, 36W, 49W, 64W or 81W	Selects an item station's TX power level to transmit.
Height	10ft , 20ft, 40ft, 80ft, 160ft, 320ft, 640ft, 1280ft, 2560ft, 5120ft*	Selects the height of the item station to transmit.
Gain	0dB ~9dB	Selects the antenna gain of the item station to transmit.

* The unit may differ, depending on the "Display Unit" settings. (p. 74)

7 MENU SCREEN

■ Menu items and Default settings (Continued)

Directivity	Omni , 45°NE, 90°E, 135°SE, 180°S, 225°SW, 270°W, 315°NW, 360°N	Selects the antenna directivity of the item station to transmit.
SSID	--- , (-0), -1~-15 or -A~-Z	Selects the APRS® call sign SSID for the item station.
Weather		
Symbol	WX Station	Selects a weather station's symbol to transmit.
SSID	--- , (-0), -1~-15 or -A~-Z	Selects the APRS® call sign SSID for the weather station.
Comment		Enters a weather station's comment to transmit.
Time Stamp	OFF, DHM or HMS	Selects a format to transmit the current UTC time as a time stamp.
NMEA		
GPS Sentence	RMC, GGA , GLL, VTG, GSA or GSV	Transmits position data in selected GPS sentences.
GPS Message		Enter a GPS message to be transmitted.
GPS Information		Displays the received GPS information.
GPS Position		Displays your position, RX station, GPS memory and Alarm positions.
GPS Memory	(No Group), A~Z	Shows the GPS memory contents.
GPS Alarm		
Alarm Select	OFF , RX, Group or Memory	Select the target for the GPS alarm function.
Alarm Area (Group)	0'05"/0.08'~ 0'15"/0.25' ~ 59'59"/59.99'	Enter the GPS alarm active range.
Alarm Area (RX/Memory)	Limited, Extended or Both	Select the GPS alarm active range.
GPS Logger*		
GPS Logger	OFF or ON	Turns the GPS logger function ON or OFF, to store your route as you move.
Record Interval	1sec, 5sec , 10sec, 30sec or 60sec	Selects the GPS Logger function record interval.

* Be sure to insert the SD card into the transceiver before selecting these items.

Record Sentence	<input checked="" type="checkbox"/> RMC/ <input checked="" type="checkbox"/> GGA/ <input checked="" type="checkbox"/> VTG/ <input checked="" type="checkbox"/> GSA	Selects the GPS Logger function record sentences.
GPS Auto TX	OFF , 5sec, 10sec, 30sec, 1min, 3min, 5min, 10min or 30min	Selects a time option for the GPS automatic transmission function.
Call Sign Set and display the DV mode call signs.		
UR: CQCQCQ, R1: -----, R2: -----, MY: -----		Displays the operating call signs. Sets the operating call signs according to the type of call you want to make.
RX History Displays the received call history in the DV mode.		
LAST (MAIN)		Displays the calls your transceiver received.
DV Memory Stores call signs or repeater information to use in the DV mode.		
Your Call Sign	Blank	Stores station call signs. Add or edit call signs.
Repeater List (See the Full Manual for details of the preloaded data.)	01:~50:	Stores repeater information. Add or edit repeater information.
/// NOTE: The repeater list described in this manual may differ from your preloaded list.		
My Station Sets and stores your call sign to use in the DV mode.		
My Call Sign	1:~6:	Stores your call signs. Select or edit a call sign to use in the DV mode.
TX Message	1:~5: or OFF	Stores TX Messages. Select or edit TX Message to use in the DV mode.
DV Set Sets values for the DV mode operations.		
Tone Control		
RX Bass	Cut, Normal or Boost	Sets the DV mode received audio bass filter level to Cut, Normal or Boost.

7 MENU SCREEN

■ Menu items and Default settings (Continued)

RX Treble	Cut, Normal or Boost	Sets the DV mode received audio treble filter level to Cut, Normal or Boost.
RX Bass Boost	OFF or ON	Turns the DV mode received audio Bass Boost function ON or OFF
TX Bass	Cut, Normal or Boost	Sets the DV mode transmit audio bass filter level to Cut, Normal or Boost.
TX Treble	Cut, Normal or Boost	Sets the DV mode transmit audio treble filter level to Cut, Normal or Boost.
Auto Reply	OFF , ON, Voice, Position (Main Only) or Position (Main/Sub)	Selects the Automatic Reply function.
DV Data TX	PTT or Auto	Selects manually or automatically to transmit low speed data.
DV Fast Data		The DV Fast Data function uses the data and the audio frames to send data approximately 3.5 times faster than the normal speed. So, no audio can be sent.
Fast Data	OFF or ON	Selects whether or not to use DV Fast data function for data communication in the DV mode.
GPS Data Speed	Slow or Fast	Set the GPS data speed when the data is sent using the DV Fast Data function.
TX Delay (PTT)	1sec~ 2sec ~10sec or OFF	Set the TX delay time after releasing [PTT] when the "DV Data TX" item is set to "PTT" and data is sent using the DV Fast data function.
Digital Monitor	Auto , Digital or Analog	Selects the DV mode RX monitoring when [SQL] is held down.
Digital Repeater Set	OFF or ON	Turns the digital repeater setting function ON or OFF. This function is usable in any DV mode except using the DR function.
DV Auto Detect	OFF or ON	Turns the DV mode automatic detect function ON or OFF.

RX Record (RPT)	ALL or Latest Only	The transceiver can record the data of up to 50 individual calls.
BK	OFF or ON	Turns the BK (Break-in) function ON or OFF. The BK function allows you to break into a conversation between two stations with call sign squelch enabled.
EMR	OFF or ON	Turns the EMR (Enhanced Monitor Request) communication mode ON or OFF. After turning OFF the transceiver, the EMR mode will be cancelled.
EMR AF Level	0~ 19 ~32	Sets the audio output level when an EMR mode signal is received.

SPEECH

Sets the Speech functions.

RX Call Sign SPEECH	OFF, ON (Kerchunk) or ON (All)	Selects the RX call sign speech function option while ON, or turn it OFF.
RX>CS SPEECH	OFF or ON	Turns the RX>CS Speech function ON or OFF.
DIAL SPEECH	OFF or ON	Turn the Dial Speech function ON or OFF.
MODE SPEECH	OFF or ON	Turn the Operating Mode Speech function ON or OFF.
SPEECH Language	English or Japanese	Selects either English or Japanese as the desired speech language.
Alphabet	Normal or Phonetic Code	Selects the alphabet character announcement type.
SPEECH Speed	Slow or Fast	Selects Slow or Fast speech speed
SPEECH Level	0~ 7 ~9	Sets the volume level for the voice synthesizer.

DTMF

Sets the DTMF Memory functions.

DTMF Memory	d0 :~d9:, dA:~dD:, d* : or d#:	Shows a list of the DTMF memory channels. The DTMF memory can store up to 24-digit DTMF code.
DTMF Speed	100ms , 200ms, 300ms or 500ms	Selects the DTMF transfer speed.

7 MENU SCREEN

■ Menu items and Default settings (Continued)

QSO/RX Log	Sets the QSO/RX History Log options.	
QSO Log* ¹	OFF or ON	Selects to make a communication log on the SD card, or not.
RX History Log* ¹	OFF or ON	Selects to make a DV mode's receive history log on the SD card, or not.
CSV Format		
Separator/Decimal	Sep [.,] Dec [.] * ² , Sep [;] Dec [.] or Sep [;] Dec [.,]	Selects the separator and the decimal character for the CSV format.
Date	yyyy/mm/dd, mm/dd/yyyy * ² or dd/mm/yyyy	Selects the date format.
Function	Sets various function's options.	
Squelch/ATT Select	OFF, S-Meter Squelch , ATT	Selects to use the S-Meter Squelch or the Attenuator function for the [SQL] control.
Squelch Delay	Short , Long	Selects to shorten or lengthen the time until the squelch opens.
Fan Control	Slow, Mid, Fast or Auto	Selects the cooling fan control condition.
Dial Speed-UP	OFF or ON	Turns the dial speed acceleration ON or OFF.
Auto Repeater* ³	OFF or ON (DUP) , ON (DUP,TONE)	Turns the Auto Repeater function ON or OFF.
Remote MIC Key	Selects the key function for [F-1] or [F-2] on the supplied remote-control microphone.	
During RX/Standby	[F-1]:BAND/BANK [F-2]:MONITOR	Selects the key function to be used while receiving or in the standby mode.
During TX	[F-1]:T-CALL [F-2]:---	Selects the key function to be used while transmitting.

*¹ Be sure to insert the SD card into the transceiver before selecting these items.

*² The default value may differ, depending on the transceiver version.

*³ Does not appear, depending on the transceiver version.

Up/Down MIC Key		Selects the key function for [UP] or [DN] on the optional hand microphone.
During RX/Standby	[UP]:UP [DN]:DOWN	Selects the key function to be used while receiving or in the standby mode.
During TX	[UP]:--- [DN]:---	Selects the key function to be used while transmitting.
One-Touch PTT(Remote MIC)	OFF or ON	Turns the One-Touch PTT function ON or OFF.
PTT Lock	OFF or ON	Turns the PTT Lock function ON or OFF.
Busy Lockout	OFF or ON	Turns the Busy Lockout function ON or OFF.
Time-Out Timer	OFF , 1min, 3min, 5min, 10min, 15min or 30min	Selects the Time-Out Timer time options.
Active Band	Single or All	Allows continuous frequency selection across all bands by rotating [DIAL].
MIC Gain	1~2*~4	Sets the microphone sensitivity to suit your preference.
Touch Operation (Sub)	Main Select or Function Select	Sets the touch operation on the SUB band display.
Keyboard Type	Ten-key, Full keyboard	Selects the keyboard input type to enter a call sign, memory name, and so on.
Data Speed	4800bps or 9600bps	Selects the data transmission speed for low-speed communication, or between the [DATA] jack and external modules like a GPS receiver, and so on.
CI-V		
CI-V Address	01h~ 8Ch ~DFh	Sets the transceiver's unique CI-V hexadecimal address code.
CI-V Baud Rate	4800, 9600, 19200 or Auto	Sets the CI-V code transfer speed.
CI-V Transceive	OFF or ON	Turns the CI-V Transceive function ON or OFF.
CI-V Bluetooth→REMOTE transceive Address	00h ~DFh	Sets the address to inhibit the external control with CI-V for the transceiver through the [SP2] (REMOTE) jack.

* The default value may differ, depending on the transceiver version.

7 MENU SCREEN

■ Menu items and Default settings (Continued)

Heterodyne		
Heterodyne (A BAND VHF)	Normal or Reverse	Effective to eliminate internal spurious that may occur in a rare combination of dual band frequencies, when operating VHF on the A band.
Heterodyne (A BAND UHF)	Normal or Reverse	Effective to eliminate internal spurious that may occur in a rare combination of dual band frequencies, when operating UHF on the A band.
Heterodyne (B BAND UHF)	Normal or Reverse	Effective to eliminate internal spurious that may occur in a rare combination of dual band frequencies, when operating UHF on the B band.
Power OFF (With No Controller)	OFF or ON	Selects whether or not to automatically turn OFF the transceiver when the controller is disconnected from the transceiver.

Display	Sets the Display options.	
Backlight	1~8	Selects the transceiver backlight option.
Backlight Night Time Setting		
Night Time Setting	OFF or ON	Select whether or not to tone down the backlight brightness for the nighttime operation.
Brightness	1~4~8	Select the backlight brightness level
Night Time Start	0:00~18:00~23:59	Set the start time for the nighttime operation.
Night Time End	0:00~6:00~23:59	Set the end time for the nighttime operation.
Auto Dimmer Setting		
Auto Dimmer	OFF , Auto-OFF, or Auto 1~7	Sets the Auto dimmer function, and the dimmer level.
Auto Dimmer Timer	5sec , 10sec	Selects the backlight ON time period.
Touch Operation (Dimmed)	Brighten, Brighten & Action	Selects whether or not to brighten and make an action when you touch the dimmed panel.
Auto Dimmer Cancel (PTT)	OFF or ON	Select the transceiver operation for when [PTT] is pushed while the Auto Dimmer is activated.

Auto Dimmer Cancel (DV RX)	OFF or ON	Select the transceiver operation for when receiving a DV signal while the Auto Dimmer is activated.
LCD Contrast	1~8~16	Sets the contrast level of the LCD.
RX Call Sign	OFF, Normal , RX Hold or Hold	Selects the call sign and message display option when receiving a call.
RX Position Indicator	OFF or ON	Selects whether or not to display the indicator when the position data is included in the signal received in the DV mode.
RX Position Display	OFF, ON (Main/Sub) or ON (Main Only)	Selects whether or not to display the caller's position data in a dialog when the data is included in the signal received in the DV mode.
RX Position Display Timer	5sec, 10sec , 15sec, 30sec, Hold	Sets the RX position data display time period.
Reply Position Display	OFF or ON	Selects whether or not to display the caller's position data in a dialog when the data is included in the Auto Reply signal.
TX Call Sign	OFF, Your Call Sign or My Call Sign	Selects whether or not to display My or Your call sign while transmitting.
Scroll Speed	Slow or Fast	Selects the scrolling speed of the message, call sign, or other text.
Opening Message	OFF or ON	Selects whether or not to display the opening message at power ON.
Voltage (Power ON)	OFF or ON	Selects whether or not to display the voltage of the external DC power source at power ON.
Clock/Voltage Display	Clock or Voltage	Select whether to display the clock or voltage at the top of the LCD.
Display Unit		
Latitude/Longitude	ddd°mm.mm' , ddd°mm'ss"	Selects position format to display the position.
Altitude/Distance	m, ft/ml*	Selects units to display the distance and altitude.
Speed	km/h, mph* or knots	Selects units to display the speed.

* The default value may differ, depending on the transceiver version.

7 MENU SCREEN

■ Menu items and Default settings (Continued)

Temperature	°C, F*	Selects units to display the temperature.
Barometric	hPa, mb, mmHg, inHg*	Selects units to display the barometric pressure.
Rainfall	mm, inch*	Selects units to display the rainfall.
Wind Speed	m/s, mph* , knots	Selects units to display the wind speed.
Display Language	English or Japanese	Selects the display language in the DR screen or Menu mode. When “English” is selected in System Language, this setting will disappear.
System Language	English or Japanese	Selects English or Japanese as the system language of the transceiver.

Sounds

Sets the Sound options.

Beep Level	0-9	Sets the beep output level.
Key-Touch Beep	OFF or ON	Turns the confirmation beep tones when key is pushed, ON or OFF.
Home CH Beep	OFF or ON	Turns the Home CH Beep ON or OFF.
Band Edge Beep	OFF or ON	Turns the Band edge beep ON or OFF.
Scan Stop Beep	OFF or ON	Turns the scan stop beep ON or OFF.
Standby Beep	OFF, ON, ON (to me:High Tone) or ON (to me:Alarm/High Tone)	Turns the standby beep function in the DV mode ON or OFF.
Sub Band Mute (Main RX)	OFF , Mute, Beep or Mute & Beep	Selects to mute the SUB band audio signal while receiving on the MAIN band, and/or sound a beep when a signal disappears on the SUB band.
Sub Band Mute (TX)	OFF or ON	Select whether or not to mute the SUB band audio signal while transmitting in the Dualwatch mode.
Scope AF Output	OFF or ON	Selects the audio output option during a sweep.

* The default value may differ, depending on the transceiver version.

Time Set	Sets the Time options.	
Date/Time		
DATE	2000/01/01~2099/12/31	Sets the current date.
TIME	0:00~23:59	Sets the current time.
GPS Time Correct	OFF or Auto	Sets to automatically correct the time using a GPS signal.
UTC Offset	-14:00~±0:00~+14:00	Enters the time difference between UTC and the local time.
Auto Power OFF	OFF , 30min, 60min, 90min or 120min	Turns the Auto power OFF function ON or OFF.
SD Card*	Sets the SD card options.	
Load Setting		
File selection	ALL, Except My Station, Repeater List Only	Loads the settings file to the transceiver.
Save Setting		
<<New File>>		Saves the settings as a new file.
File selection		Saves the settings in a selected file.
Save Form	Now Ver , Old Ver (1.10), or Old Ver (1.00 - 1.05)	Select the format to save the Memory channels, Menu screen item settings, and repeater lists onto an SD card.
Import/Export		
Import	Your Call Sign, Repeater List or GPS Memory	Selects to import the repeater list, UR call sign or GPS memory data in the CSV format file.
Export	Your Call Sign, Repeater List or GPS Memory	Selects to export the repeater list, UR call sign or GPS memory data in the CSV format file.

* Be sure to insert the SD card into the transceiver before selecting these items.

7 MENU SCREEN

■ Menu items and Default settings (Continued)

CSV Format		
Separator/Decimal	Sep [.,] Dec [.]* , Sep [;] Dec [.] or Sep [;] Dec [.,]	Selects the separator and the decimal character for the CSV format.
Date	yyyy/mm/dd, mm/dd/yyyy* or dd/mm/yyyy	Selects the date format.
SD Card Info		
Format		Displays the free space and remaining recording time of the card.
Unmount		Formats the card.
		Unmounts the card.
Bluetooth Set Sets the Bluetooth® options.		
Bluetooth	OFF or ON	Turns the Bluetooth® function ON or OFF.
Auto Connect	OFF or ON	Selects whether or not to automatically connect to a paired Bluetooth® device when the device is turned ON.
Pairing/Connect		
Device Search		Selects to pair or connect to a Bluetooth® device.
Search Headset		
Search Data Device		Searches for the Bluetooth® headset.
Pairing list		Searches for the Bluetooth® data device.
<<Pairing Reception>>		Displays the paired device.
		Accepts the connection request from a Bluetooth® device.
Headset Set		
AF Output	Headset Only or Headset & Speaker	Selects the AF output option for when you use a Bluetooth® headset.
Headset Function Select	Normal , Microphone or PTT	Select the desired PTT and microphone combination when either a Bluetooth® headset or the radio microphone are used.

* The default value may differ, depending on the transceiver version.

VOX		
VOX	OFF or ON	Turn the VOX function ON or OFF for when you use a Bluetooth® headset.
VOX Level	OFF, 1~5~10	Set the MIC Gain level. • When the microphone input level is higher than this set value, the transceiver starts to transmit, and the input level is lower than this set value, it returns to receive.
VOX Delay	0.5sec, 1.0sec, 1.5sec, 2.0sec, 2.5sec or 3.0sec	Sets the VOX Delay time for the transmitter stays ON after you stop speaking before the VOX switches to receive.
VOX Time-Out Timer	OFF, 1min, 2min, 3min, 4min, 5min, 10min or 15min	Sets the VOX Time-Out Timer to prevent an accidental prolonged transmission.
Icom Headset		
Power Save	OFF or ON	Sets to use the optional Icom Bluetooth® headset (VS-3). Sets the Power save function to prolong the headset battery.
One-Touch PTT	OFF or ON	Sets the One-Touch PTT function to toggle between transmission and reception by pushing [PTT].
PTT Beep	OFF or ON	Sets to sound a beep when you push [PTT].
Custom Key Beep	OFF or ON	Sets to sound a beep when you push the custom key ([PLAY]/[FWD]/[RWD]).
Custom Key	[PLAY]:---, [FWD]:UP, [RWD]: DOWN	Selects the key function of the custom key ([PLAY]/[FWD]/[RWD]).
Data Device Set		
Serialport Function	CI-V (Echo Back OFF), CI-V(Echo Back ON) or DV Data	Sets the data device options. Selects to transmit or receive the CI-V command or the DV data.

7 MENU SCREEN

■ Menu items and Default settings (Continued)

Bluetooth Device Information	Shows the optional UT-133 Bluetooth® UNIT information.
Initialize Bluetooth Device	Selects to reset the optional UT-133 Bluetooth® UNIT.

Others

Sets other options.

Information		
Voltage		Shows the voltage of the external DC power source.
Version		Shows the transceiver's firmware version number.
Clone		
Clone Mode		Reads or writes the CS-5100 data from or to the PC.
Repeater Mode*		
<<Repeater Mode>>		Selects the Repeater mode.
Hang Up Time	OFF or ON	Selects the hangup time to cancel the transmission.
Touch Screen Calibration		Adjusts the touch screen.
Reset		
Partial Reset		Returns all settings to their defaults, without clearing the memory contents, call sign memories or repeater lists.
All Reset		Clears all programming and memories, and return all settings to their defaults.

*Does not appear, depending on the transceiver version.

■ Connect controller to main unit

Connect the controller to the main unit with the supplied control cable.

- The following longer cables may be required, depending on the installation location.

OPC-440 MIC EXTENSION CABLE:	5 m (16.4 ft)
OPC-647 MIC EXTENSION CABLE:	2.5 m (8.2 ft)
OPC-1156 CONTROLLER EXTENSION CABLE:	3.5 m (11.4 ft)
SP-35 EXTERNAL SPEAKER:	2 m (6.5 ft)
SP-35L EXTERNAL SPEAKER:	6 m (19.6 ft)
SP-30 EXTERNAL SPEAKER:	2.8 m (9.1 ft)

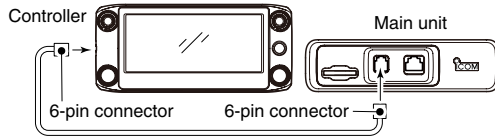

■ Microphone connection

Plug in the microphone to the microphone connector on the main unit as shown in the illustration below.

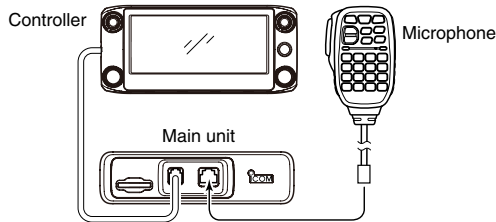

■ DC power supply connection

Use a 13.8 V DC power supply with at least 20 A capacity. Connect the black DC power cable to the (-) Negative terminal, and the red DC power cable to the (+) Positive terminal.

⚠ WARNING! NEVER remove the fuse holders from the DC power cable.

• CONNECTING TO A DC POWER SUPPLY

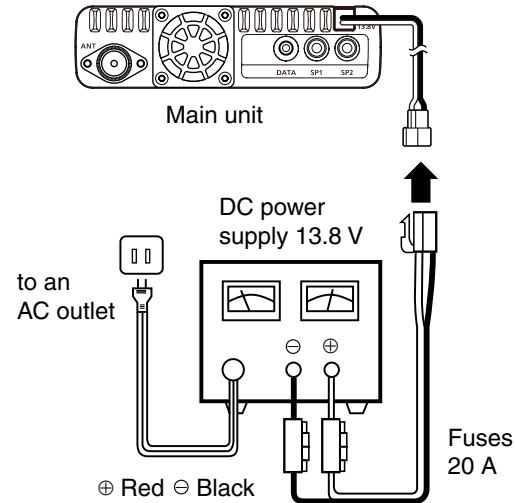

⚡ See page 85 for a car battery connection.

■ Installing a controller

◆ When installing into your vehicle

You can install the controller on the dashboard or the console of your vehicle with the optional MBA-2* CONTROLLER BRACKET and the MBF-1 MOUNTING BASE. (p. 82)

*MBA-2 may be supplied, depending on the transceiver's version.

- ① Attach the MBF-1 on the dashboard or the console.
 - See the MBF-1 instruction manual for details.

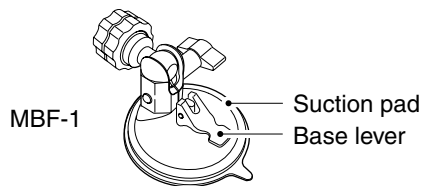

- ② Attach the MBA-2 to the controller's rear panel with the supplied two screws as shown below.

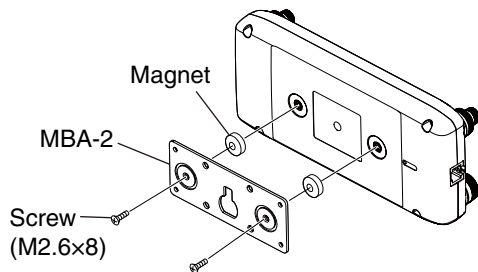

- ③ Slide the MBA-2's guide down over the MBF-1's locking head, as shown below.
 - Be sure the locking head fits into the slot at the top of the guide.
- ④ Tighten the lock knob to securely attach the controller.
- ⑤ Adjust the viewing angle of the controller, then tighten the adjustment knob.

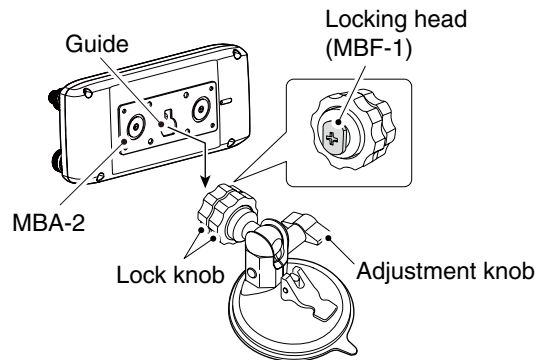

◇ **When installing to a flat surface**

You can install the controller on a flat surface with the optional MBA-2*¹ CONTROLLER BRACKET.

When attaching the bracket onto a wall, use a self-tapping screw*² (3 mm(d)).

*¹ MBA-2 may be supplied, depending on the transceiver's version.

*² Purchase separately

Attach the magnet to the Controller bracket

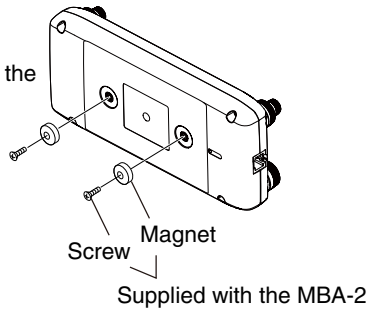

When attaching the bracket onto a wall

Screw (3 mm(d))
Purchase separately

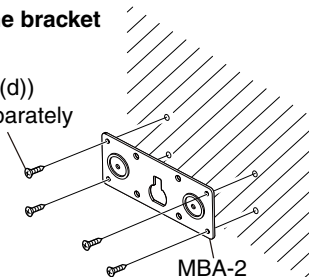

◇ **About GPS antenna**

The GPS antenna is located at the top back of the controller. If the controller's rear panel is covered with any object that interrupts the GPS signals from the satellites, the GPS receiver will not calculate its position.

Therefore, when you are using the GPS feature, be sure the controller is positioned so the antenna has a clear view to receive signals from the satellites.

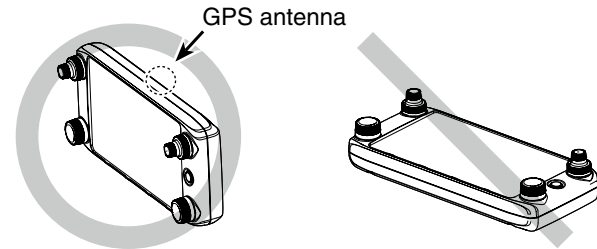
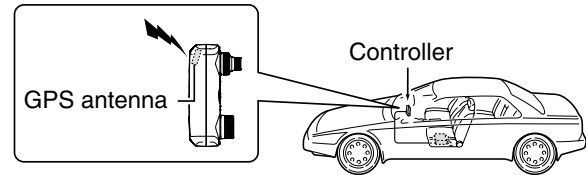

8 INSTALLATION AND CONNECTIONS

■ Installing in a vehicle

CAUTION: NEVER place the main unit or remote controller where normal operation of the vehicle may be hindered or where it could cause bodily injury.

CAUTION: NEVER place the main unit or remote controller where air bag deployment may be obstructed.

DO NOT place the transceiver or remote controller where hot or cold air blows directly onto it.

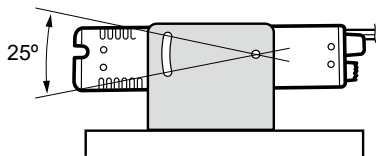
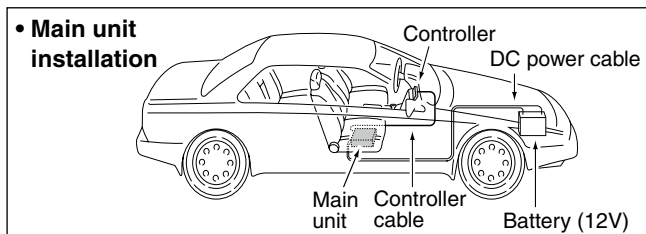

NOTE: Contact your car dealer or Icom dealer for advice for installing in a vehicle.

◇ Using the mounting bracket

You can install the main unit on the dashboard or the console of your vehicle with the optional MBF-4 MOBILE BRACKET.

- ① Drill 4 holes where the mounting bracket is to be installed.
 - Approximately 5.5 ~ 5.6 mm (0.21 ~ 0.22 inch)(d) when using nuts, approximately 2 ~ 3 mm (0.08 ~ 0.12 inch)(d) when using self-tapping screws.
- ② Insert the supplied screws, nuts and washers through the mounting bracket and tighten.
- ③ Adjust the angle to suit your needs.

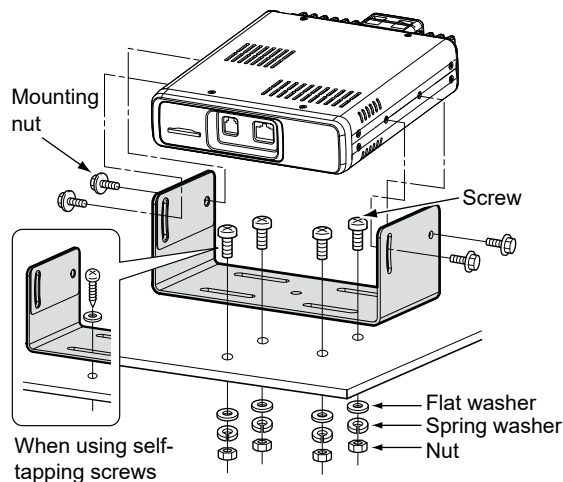

■ Installing an antenna

To obtain maximum performance from the transceiver, select a high-quality antenna and mount it in a good location.

• Antenna location

Roof-mount antenna
(Drill a hole or use a magnetic mount.)

Gutter-mount antenna

Trunk-mount antenna

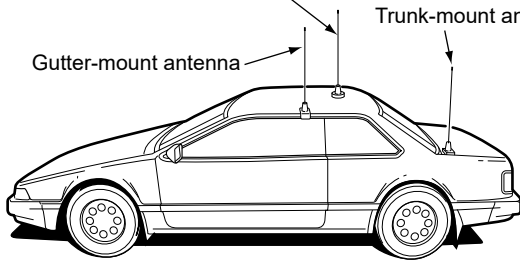

➔ Connect the coaxial cable that the antenna is connected to the antenna connector on the rear panel of the main unit.

Antenna connector

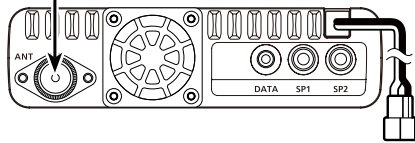

NOTE:

- Make the coaxial cable as short as possible.
- Be sure to seal the antenna connection.

◇ About the antenna

For radio communications, the antenna is of critically importance, along with output power and receiver sensitivity. Select a well-matched 50 Ω antenna and coaxial cable feed-line. We recommend 1.5:1 or better Voltage Standing Wave Ratio (VSWR) on your operating bands.

◇ About the internal duplexer

The transceiver has an internal duplexer, and you can easily connect a dual band antenna (VHF/UHF). If you connect separate the VHF and UHF antennas, use an external duplexer.

When you connect VHF and UHF antennas separately:

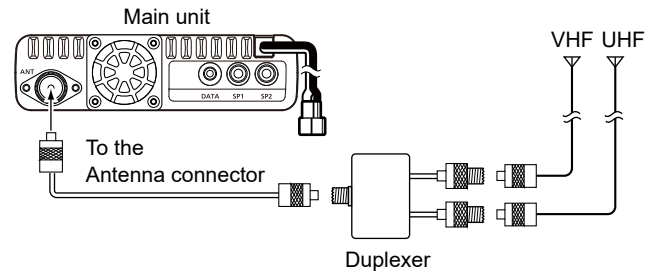

8 INSTALLATION AND CONNECTIONS

■ Battery connection

⚠ WARNING!

- **NEVER** remove the fuses from the cable connecting the transceiver to a power source, such as a car battery.
- **NEVER** connect the transceiver directly to a 24 V battery.

The transceiver may not receive well on some frequencies when installed in a hybrid vehicle, or any type of electric vehicle (fuel cell vehicle). This is because vehicle's electric components such as the inverter system generate a lot of electric noise.

- **DO NOT** use a cigarette lighter socket as a power source when operating in a vehicle. The plug may cause voltage drops and ignition noise may be superimposed onto transmit or receive audio.
- Use a rubber grommet when passing the DC power cable through a metal plate to prevent a short circuit.

⚠ WARNING! (About DC power supply)

- Make sure DC power cable polarity is correct.
Red: Positive + terminal
Black: Negative – terminal
- **DO NOT** pull or bend the DC power cable.

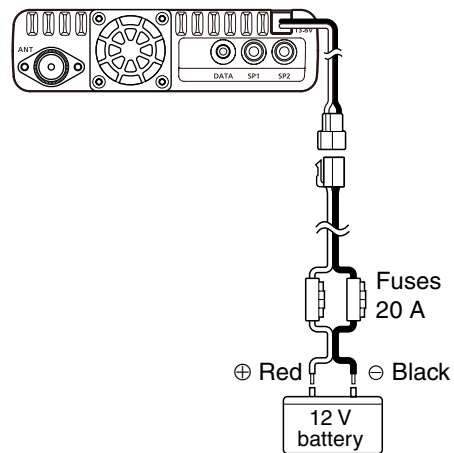

CONNECTING A VEHICLE BATTERY

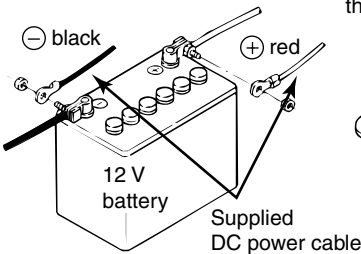
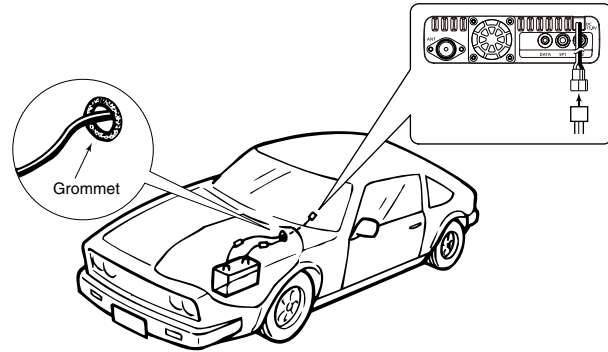

NOTE: Use terminals for the cable connections.

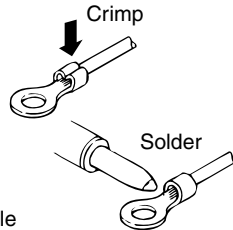

External GPS receiver connection

When "External GPS" is set to the "GPS Select" item, connect an NMEA format compatible external GPS receiver to the [DATA] jack using the OPC-1529R as shown below. See page 64 for setting of the "GPS Select" item.

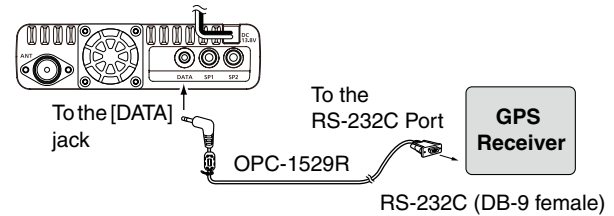

■ Resetting

Occasionally, erroneous information will be displayed when, for example, first applying power. This may be caused externally by static electricity or by other factors.

If this problem occurs, turn OFF power.

After waiting a few seconds, turn ON power again. If the problem is still there, perform a Partial reset or an All reset.

A Partial reset resets the operating settings to their default values (VFO frequency, VFO settings, menu contents) without clearing the items below:

- Memory channel contents
- Call channel contents
- Message data
- GPS Memory contents
- Scan Edge contents
- Call sign memories
- DTMF memory contents
- Repeater list

BE CAREFUL! An All reset clears all programming and returns all settings to their factory defaults. See the Full Manual for details.

◇ Partial Reset

① Touch [MENU].

② Touch "Reset."

(Manage Memory > Others > **Reset**)

- If the item is not displayed, touch [▲] or [▼] one or more times to select the page.



③ Touch "Partial Reset."



④ Touch [YES].

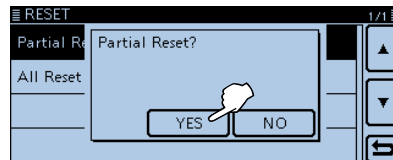

- The transceiver displays "PARTIAL RESET," then the partial reset is completed.

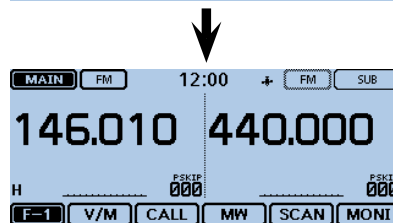

■ Power protect function

The transceiver is equipped with a protection circuit for the power amplifier. The circuit activates when the transceiver continuously transmit at high power, and then temperature becomes extremely high.

In this case, the transceiver automatically reduces transmit output power to low (approximately 5 W).

When the Power protect function activates, wait until the transceiver's temperature returns to normal.

NOTE: When the power supply voltage is over 17.0 V, the transceiver automatically displays "Over Voltage," and then sounds a warning beep. In this case, the transceiver may be damaged, and contact your nearest Icom Dealer or Service Center.

■ Spurious signals

Spurious signals may occur at some frequencies. These are created in the internal circuit and does not indicate a transceiver malfunction.

You may avoid the spurious signals with the Heterodyne function. (p. 73)

■ Fuse replacement

A fuse is installed in each fuse holder of the supplied DC power cable. If a fuse blows, or the transceiver stops functioning, track down the source of the problem if possible, repair it and then replace the damaged fuse with a new rated one (FGBO 125 V 20 A).

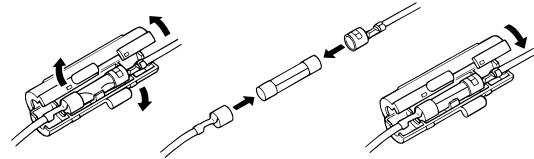

WARNING! NEVER remove the fuse holders from the DC power cable. **USE** only the specified fuses.

NOTE: Before replacing the fuse, be sure to disconnect the DC cable from the power supply.

Fuse Cording explanation

Fuse Coding: FUSE 32 V–250 V 20 A
 Fuse Voltage Rating: 32 to 250 Volts
 Fuse Current Rating: 20 Amperes

DISPOSAL



The crossed-out wheeled-bin symbol on your product, literature, or packaging reminds you that in the European Union, all electrical and electronic products, batteries, and accumulators (rechargeable batteries) must be taken to designated collection locations at the end of their working life. Do not dispose of these products as unsorted municipal waste. Dispose of them according to the laws in your area.

Icom is not responsible for the destruction, damage to, or performance of any Icom or non-Icom equipment, if the malfunction is because of:

- Force majeure, including, but not limited to, fires, earthquakes, storms, floods, lightning, other natural disasters, disturbances, riots, war, or radioactive contamination.
- The use of Icom transceivers with any equipment that is not manufactured or approved by Icom.

ABOUT CE AND DOC



Hereby, Icom Inc. declares that the versions of ID-5100E which have the “CE” symbol on the product, comply with the essential requirements of the Radio Equipment Directive, 2014/53/EU, and the restriction of the use of certain hazardous substances in electrical and electronic equipment Directive, 2011/65/EU. The full text of the EU declaration of conformity is available at the following internet address:
<https://www.icomjapan.com/support/>

FCC INFORMATION

This equipment has been tested and found to comply with the limits for a Class B digital device, pursuant to part 15 of the FCC Rules. These limits are designed to provide reasonable protection against harmful interference in a residential installation. This equipment generates, uses and can radiate radio frequency energy and, if not installed and used in accordance with the instructions, may cause harmful interference to radio communications. However, there is no guarantee that interference will not occur in a particular installation. If this equipment does cause harmful interference to radio or television reception, which can be determined by turning the equipment off and on, the user is encouraged to try to correct the interference by one or more of the following measures:

- Reorient or relocate the receiving antenna.
- Increase the separation between the equipment and receiver.
- Connect the equipment into an outlet on a circuit different from that to which the receiver is connected.
- Consult the dealer or an experienced radio/TV technician for help.

CAUTION: Changes or modifications to this device, not expressly approved by Icom Inc., could void your authority to operate this device under FCC regulations.

INDEX

A	
About the manuals.....	v
Access repeater	
Accessing repeaters	31
Antenna	
Antenna installation.....	84
Accessories	ii
Audio volume setting	11
B	
Band	
Operating band selection	13
Operating band setting.....	13
Basic operation.....	11
Battery Connection.....	85
C	
Call	
Calling an individual station	41
Gateway Repeater call.....	39
Local area call.....	37
Simplex call.....	29
Call channel mode.....	15
Call sign	
Enter your call sign into the transceiver	24
Capturing a call sign	35
Register.....	27
Coaxial cable	84
Connection	
Connect controller to main unit	81
Controller	
Display (Touch screen).....	2
Front panel	1
D	
DC power supply connection.....	80
Disposal.....	89
D-STAR operation.....	21
DR (D-STAR Repeater) function	22
Introduction	22
Selection	16
E	
Explicit definitions.....	i
F	
FCC information	90
Function menu.....	5
Fuse replacement.....	88
Frequency	
Direct frequency input.....	14
Setting.....	10

G	
GPS	
About GPS antenna	82
Operation	59
GPS receive setting	59
GPS Position screen	60
Checking your GPS position	59
Displaying Position Data	59
H	
Home channel	
Home channel function	18
Setting	18
I	
Important	i
Important notes	i
Information	89
Installation and connection	80
Connect controller to main unit	80
Installing in a vehicle	83
Microphone connection	80
Remote installation	83
When installing into your vehicle	81
When installing to a flat surface	82
L	
Lock function	17

M	
MAIN or SUB band selection	12
Menu screen	
Entering	61
Memory channel	
Memory mode	15
Memory operation	19
Checking the Memory contents	19
Setting a Memory channel	10
Writing Memory channels	19
Maintenance	87
Main unit - Front and rear panels	7
Menu screen	61
Menu items and Default settings	62
Menu item selection	61
Microphone	
Microphone connection	80
Microphone (HM-207)	8
Mode	
Mode and the DR function selection	15
Operating mode selection	17
Watch mode selection	12
P	
Panel description	1
Playing recorded audio	58
Power ON	11
Power protect function	88
Precautions	vi

INDEX

R	
Recording a QSO audio	57
Reflector	
Echo Testing.....	49
Linking to a reflector.....	45
Operation	45
Requesting repeater information.....	50
Unlinking a reflector	48
Using a reflector.....	47
What is the reflector?	45
Register your call sign at a gateway repeater.....	27
Repeater list	
Updating the repeater list.....	51
Resetting	
Partial Reset	87
S	
SD card.....	55
Formatting	56
Inserting	56
Playing recorded audio	58
Removing.....	58
Recording a QSO audio.....	57
Speech function.....	18
Spurious signals	88
Squelch level setting.....	11

T	
Touch screen	
Maintenance	iii
Operation	iii
Precautions	iii
Touch Area.....	iii
Transmitting	16
Troubleshooting	43
Tuning step selection	11
U	
Unique features of D-STAR	21
Using the RX history.....	33
V	
VFO mode	15
Voice cording technology.....	v
W	
Watch mode selection	12
Ways to Communicate with the DR function	23
When using the GPS receiver	ii
Weather channel mode	15

Count on us!

A7115D-2EX-8
Printed in Japan
© 2014–2021 Icom Inc. Mar. 2021

Icom Inc.
1-1-32 Kamiminami, Hirano-ku, Osaka 547-0003, Japan