

Getac

B300

USER'S MANUAL

Rugged Mobile Computing Solutions

July 2010

TRADEMARKS

The Bluetooth® word mark and logos are registered trademarks owned by Bluetooth SIG, Inc.

All other brand and product names are trademarks or registered trademarks of their respective owners.

NOTE

The information in this manual is subject to change without notice. For the latest version of the manual, please visit the Getac website at www.getac.com.

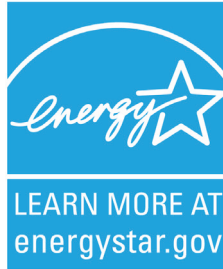

ENERGY STAR® is a government program that offers businesses and consumers energy-efficient solutions, making it easy to save money while protecting the environment for future generations.

Please reference ENERGY STAR® related information from www.energystar.gov.

As an ENERGY STAR® Partner, Getac Technology Corporation has determined that this product meets the ENERGY STAR® guidelines for energy efficiency.

An ENERGY STAR® qualified computer uses 70 % less electricity than computers without enabled power management features.

Earning the ENERGY STAR®

- When every home office is powered by equipment that has earned the ENERGY STAR®, the change will keep over 289 billion pounds of greenhouse gases out of the air.
- If left inactive, ENERGY STAR® qualified computers enter a low-power mode and may use 15 watts or less. New chip technologies make power management features more reliable, dependable, and user-friendly than even just a few years ago.
- Spending a large portion of time in low-power mode not only saves energy, but helps equipment run cooler and last longer.
- Businesses that use ENERGY STAR® enabled office equipment may realize additional savings on air conditioning and maintenance.

- Over its lifetime, ENERGY STAR® qualified equipment in a single home office (e.g., computer, monitor, printer, and fax) can save enough electricity to light an entire home for more than 4 years.
- Power management (“sleep settings”) on computers and monitors can result in much savings annually.

Remember, saving energy prevents pollution

Because most computer equipment is left on 24 hours a day, power management features are important for saving energy and are an easy way to reduce air pollution. By using less energy, these products help lower consumers’ utility bills, and prevent greenhouse gas emissions.



LEARN MORE AT
energystar.gov

Table of Contents

Chapter 1	Getting Started.....	1-1
	Getting the Computer Running.....	1-2
	Unpacking	1-2
	Using the Tether (Optional).....	1-3
	Connecting to AC Power.....	1-4
	Opening the Cover	1-5
	Turning On and Off the Computer	1-6
	Taking a Look at the Computer.....	1-7
	Front Components.....	1-7
	Rear Components	1-8
	Right-Side Components.....	1-9
	Left-Side Components.....	1-11
	Top-open Components.....	1-12
	Bottom Components	1-15
	Closing Connector Covers	1-16
Chapter 2	Operating Your Computer.....	2-1
	Starting and Stopping the Computer.....	2-2
	Starting the Computer	2-2
	Stopping the Computer	2-2
	Using the Keyboard	2-4
	Typewriter Keys	2-4
	Cursor-Control Keys.....	2-4
	Numeric Keypad	2-5
	Function Keys.....	2-6
	Fn Key	2-6
	Hot Keys	2-6
	Using the Touchpad.....	2-9

Configuring the Touchpad.....	2-11
Using the Touchscreen (Optional)	2-12
Using the Quick Buttons.....	2-14
Using the Hard Disk Drive	2-15
Installing a Second Hard Disk Drive (Optional)	2-15
Using the DVD Drive (Optional).....	2-17
Inserting and Removing a Disc	2-18
Using the Network Features	2-20
Using the Modem	2-20
Using the LAN	2-21
Using the Wireless LAN	2-22
Using the Bluetooth Feature.....	2-25
Turning On/Off the Bluetooth Radio	2-25
Connecting to another Bluetooth Device.....	2-27
Using the 3G Feature (Optional).....	2-29
Installing a SIM Card.....	2-30
Turning On/Off the 3G Radio	2-32
Using the Fingerprint Sensor	2-33
Chapter 3	
Managing Power	3-1
AC Adapter.....	3-2
Battery Pack.....	3-3
Charging the Battery Pack	3-3
Initializing the Battery Pack.....	3-4
Checking the Battery Level	3-5
Replacing the Battery Pack	3-6
Installing a Second Battery Pack (Optional)	3-7
Battery Low Signals and Actions	3-9
Power Management	3-10
Hibernation.....	3-11
Power-Saving Tips.....	3-12
Chapter 4	
Expanding Your Computer	4-1
Connecting a VGA or HDMI Display Monitor	4-2
Connecting a Serial Device	4-4
Connecting a USB Device	4-5
Connecting an eSATA Device.....	4-6

	Connecting an IEEE 1394 Device.....	4-7
	Connecting Audio Devices	4-8
	Using Smart Cards (Optional).....	4-9
	Using PC Cards.....	4-10
	Using ExpressCards (Optional)	4-12
	Using the MMC/SD Card Reader	4-14
	Using the Port Replicator (Optional).....	4-16
	System Memory Upgrade	4-17
Chapter 5	Using BIOS Setup and System Recovery	5-1
	BIOS Setup	5-2
	When and How to Use	5-2
	Information Menu	5-3
	Main Menu.....	5-4
	Advanced Menu.....	5-5
	Security Menu	5-10
	Boot Menu	5-12
	Exit Menu	5-13
	System Recovery.....	5-15
Chapter 6	Using the TPM and P1 Utility.....	6-1
	Using TPM (Trusted Platform Module).....	6-2
	P1 Quick Launch Key Utility	6-3
Chapter 7	Caring for the Computer.....	7-1
	Protecting the Computer	7-2
	Using an Anti-Virus Strategy	7-2
	Using Windows Action Center.....	7-2
	Using the Cable Lock.....	7-3
	Taking Care of the Computer	7-4
	Location Guidelines	7-4
	General Guidelines	7-4
	Cleaning Guidelines.....	7-5
	Battery Pack Guidelines.....	7-5
	Touchscreen Guidelines.....	7-6
	When Traveling.....	7-8

Chapter 8	Troubleshooting	8-1
	Preliminary Checklist.....	8-2
	Solving Common Problems	8-3
	Battery Problems	8-3
	Bluetooth Wireless Transmission Problems	8-3
	Display Problems.....	8-4
	ExpressCard Problems.....	8-5
	Hardware Device Problems.....	8-5
	Hard Disk Drive Problems.....	8-5
	Keyboard, Mouse, and Touchpad Problems.....	8-6
	LAN Problems.....	8-7
	Modem Problems.....	8-7
	DVD Drive Problems	8-7
	PC Card Problems.....	8-8
	Power Management Problems	8-9
	Software Problems	8-9
	Sound Problems	8-10
	Startup Problems	8-10
	WLAN Problems	8-11
	Other Problems.....	8-12
	Resetting the Computer	8-13
Appendix A	Specifications	A-1
Appendix B	Regulatory Information	B-1
	On the Use of the System.....	B-2
	Class B Regulations.....	B-2
	Safety Notices	B-3
	On the Use of the RF Device	B-6
	USA and Canada Safety Requirements and Notices	B-6
	European Union CE Marking and Compliance Notices....	B-9

Chapter 1

Getting Started

Congratulations on purchasing this rugged computer.

This chapter first tells you step by step how to get the computer up and running. Then, you will find a section briefly introducing the external components of the computer.

Getting the Computer Running

This section guides you through the procedures for getting the computer ready for operation.

Unpacking

After unpacking the shipping carton, you should find these standard items:

- Rugged computer
- Accessories:
 - AC adapter
 - AC power cord
 - Stylus and tether (depending on your model)

Inspect all the items. If any item is damaged or missing, notify your dealer immediately.

Keep the shipping carton and packing materials in case you need to ship or store the computer in the future.

Using the Tether (Optional)

A tether is provided for attaching the stylus to your computer.

1. Insert one of the tether's loop ends through the hole of the stylus (as indicated by **1** below). Then, insert the other end through the first loop (as indicated by **2** below) and pull it tight.



2. Insert the other loop end to the hook on the computer (as indicated by **1** below). Then, insert the stylus end through the loop (as indicated by **2** below) and pull it tight.



Connecting to AC Power

The computer operates either on the external AC power or internal battery power. It is suggested that you use AC power when you start up the computer for the very first time.

CAUTION: Use only the AC adapter included with your computer. Using other AC adapters may damage the computer.

1. Turn off the computer.
2. Plug the DC cord of the AC adapter to the power connector of the computer (❶).
3. Plug the female end of the AC power cord to the AC adapter and the male end to an electrical outlet (❷).



4. When the AC adapter is connected, power is being supplied from the electrical outlet to the AC adapter and onto your computer. Now, you are ready to turn on the computer.
5. When the AC adapter is connected, it also charges the battery pack. The Battery Charge Indicator on the computer glows amber to indicate that charging is in progress. When the battery is fully charged, the Battery

Charge Indicator () glows green. (For information on using battery power, see Chapter 3.)

CAUTION:

- When you disconnect the AC adapter, disconnect from the electrical outlet first and then from the computer. A reverse procedure may damage the AC adapter or the computer.
- When unplugging the connector, always hold the plug head. Never pull on the cord.

Opening the Cover

CAUTION: Be gentle when opening and closing the cover. Opening it vigorously or slamming it shut could damage the computer.

Open the top cover by pushing on the cover latch (❶) and lifting up the cover (❷). You can tilt the cover forward or backward for optimal viewing clarity.



Turning On and Off the Computer

Turning On

1. Make sure that the computer is connected to AC power or battery is fully charged.
2. Open the top cover
3. Press the power button (⏻).



4. Each time the computer is turned on, it performs a Power-On Self Test (POST), and the operating system such as Windows should start.

Turning Off

To turn off the computer power, use the “Shut Down” command of your operating system.

NOTE: There are other ways you can stop the computer so that you will be back to where you left off when you next turn on the computer. (See “Stopping the Computer” in Chapter 2 for information.)

CAUTION: If you have to turn the computer on again immediately after turning it off, wait for at least five seconds. Turning the computer off and on rapidly can damage it.

Taking a Look at the Computer

NOTE: Depending on the model you purchased, the appearance of your computer may not be exactly the same as those shown in this manual.

Front Components

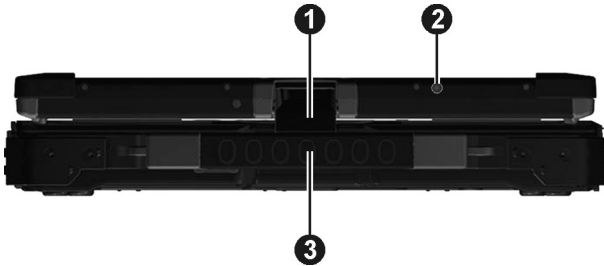

Ref	Component	Description	See Also
❶	Top Cover Latch	Locks the top cover.	P. 1-5
❷	3G Antenna	Serves as the antenna for wireless modem. NOTE: For data transmission only.	P. 2-29
❸	Handle	Provides a convenient way to carry the computer.	

Rear Components

NOTE: You need to open the covers to access the connectors.

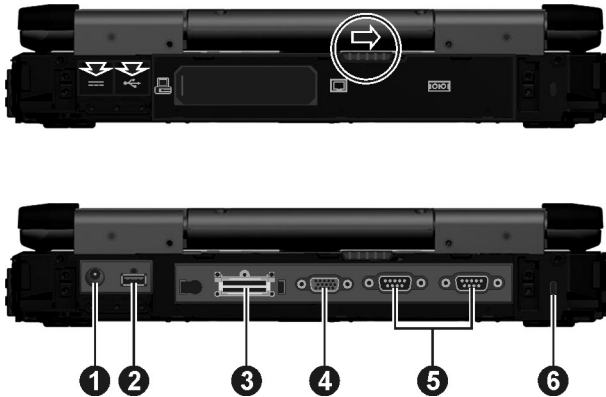

Ref	Component	Description	See Also
❶	Power Connector	Connects the AC adapter.	P. 1-3
❷	USB Port	Connects a USB device, such as a USB flash disk, printer, digital camera, joystick, and more.	P. 4-5
❸	Expansion Bus Connector	Connects to a Port Replicator.	P. 4-16
❹	VGA Connector	Connects an external display monitor.	P. 4-2
❺	Serial Connectors	Each of the two connectors connects a serial mouse or serial communication device.	P. 4-4
❻	Kensington Lock	Locks the computer to a stationary object for security.	P. 7-2

Right-Side Components

NOTE: You need to open the covers to access the connectors.

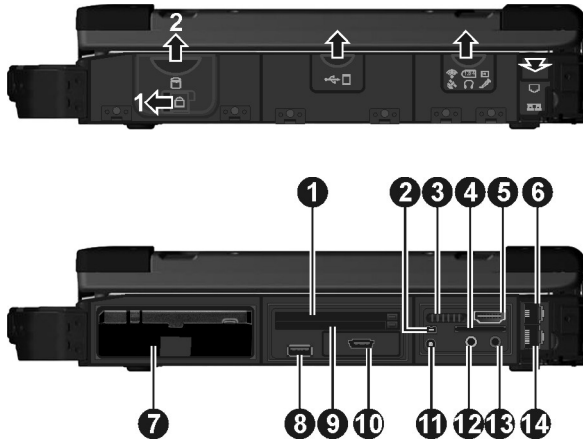

Ref	Component	Description	See Also
❶	Expansion Card Slot	Depending on your model, the slot can be any of the following:	
	ExpressCard Slot	Accepts an ExpressCard/34 or ExpressCard/54 for additional functions.	P. 4-12
	PCMCIA Slot	Accepts a PC card for additional functions.	P. 4-10
❷	Mini IEEE 1394 Port	Connects an IEEE 1394 device such as a scanner, printer, DVCAM, and VCR.	P. 4-6
❸	RF (radio frequency) On/Off Switch	Serves as the master on/off control for all the wireless modules (wireless LAN, Bluetooth, and WWAN). NOTE: Available modules on your computer depend on the configuration you purchased.	P. 2-23, 2-25, 2-29

Ref	Component	Description	See Also
4	Card Reader	Accepts a MultiMediaCard (MMC) or Secure Digital (SD) card for removable storage media.	P. 4-14
5	HDMI	Connects a HDMI (High-Definition Multimedia Interface) monitor or TV set.	P. 4-2
6	RJ-11 Connector	Connects the telephone line.	P. 2-20
7	Hard Disk Drive Compartment	Inside is the hard disk drive.	P. 2-15
8	USB Port	Connects a USB device, such as a USB flash disk, printer, digital camera, and joystick.	P. 4-5
9	Expansion Card Slot	Depending on your model, the slot can be any of the following:	
	Smart Card Reader	Accepts a smart card for additional security feature.	P. 4-9
	PCMCIA Slot	Accepts a PC card for additional functions.	P. 4-10
10	eSATA/USB Combo Port	Connects an eSATA device such as an external hard drive or optical drive.	P. 4-6
		Can also function as a USB port.	
11	GPS Antenna pass-through Connector (option)	Connects to the optional antenna for GPS receiver.	
12	Audio Output Connector	Connects a set of headphones or external speakers with amplifier.	P. 4-8
13	Microphone Connector	Connects an external microphone.	P. 4-8
14	RJ-45 Connector	Connects the LAN cable.	P. 2-21

Left-Side Components

NOTE: You need to open the covers to access the connectors.

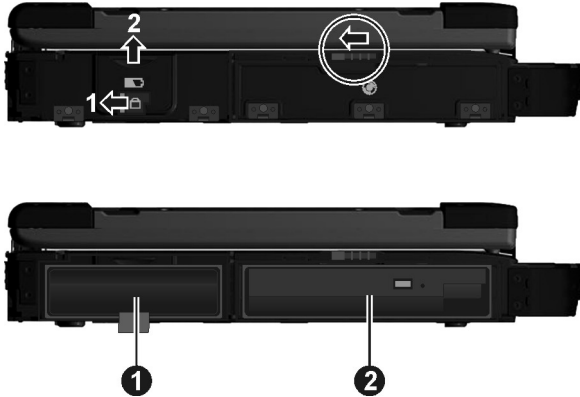





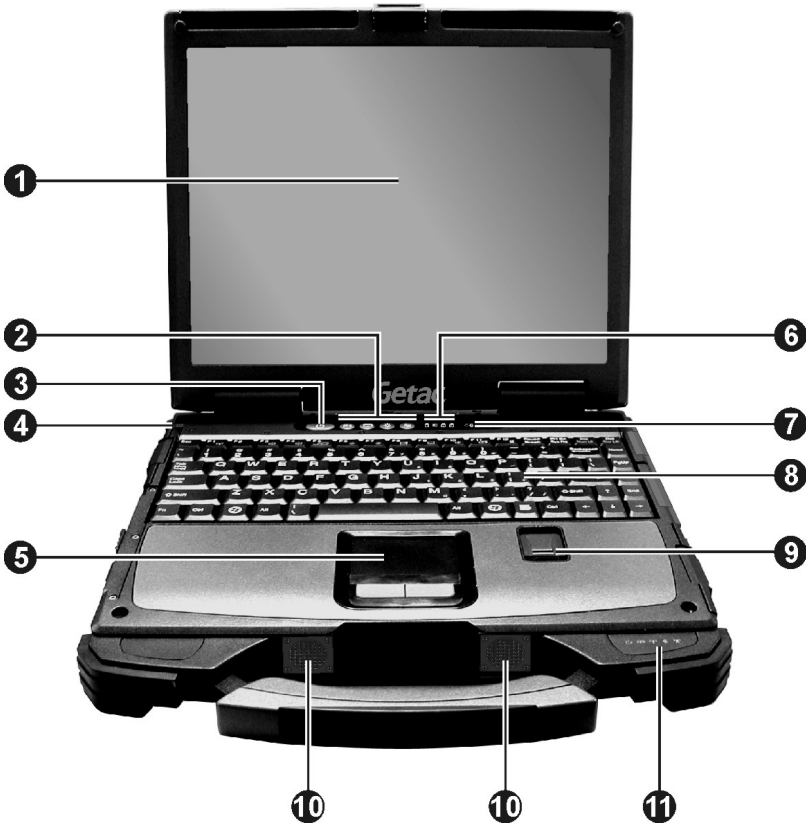









Ref	Component	Description	See Also
①	Battery Pack	Supplies power to your computer when external power is not connected.	P. 3-3
②	Media Bay	Depending on your model, the media bay may contain any of the following:	
	Combo Drive/ DVD Dual Drive/ Super Multi Drive	Accepts a compact disc for installing or loading software, accessing data, and playing music/video.	P. 2-17
	Secondary Battery Pack	Provides extra battery power.	P. 3-7
	Secondary Hard Disk Drive	Provides extra hard disk capacity.	P. 2-15

Top-open Components



Ref	Component	Description	See Also
1	LCD Screen	Displays the output of the computer. May include the optional touchscreen feature.	P. 2-12

Ref	Component	Description	See Also
2	Quick Buttons		
	P1	Turns off/on the LCD display and LED indicator by default.	P. 2-14
		Enables/disables power saving when using battery power.	P. 2-14
		Enables/disables sunlight readable display.	P. 2-14
		Enables/disables light sensor.	P. 2-14
3	Power Button 	Turns the computer power ON and OFF.	P. 1-6
4	Stylus (option)	Serves as the input device by tapping on the touchscreen to make selections and enter information.	P. 2-12
5	Touchpad	Serves as the pointing device of the computer.	P. 2-9
6	Indicators	Show the current status of the computer's devices.	
	Hard Disk Drive / DVD Drive 	Blinks green when computer is reading / writing data to the hard disk or DVD drive.	P. 2-15
	Card Reader 	Blinks green when computer is reading / writing data to the storage card.	P. 4-14
	Caps Lock 	Lights green when Caps Lock is on.	P. 2-5
	Num Lock / HDD Heater (option) 	Lights green when Num Lock is on. Lights amber when the optional hard disk heater is on.	P. 2-23
7	Microphone 	Receives sound and voice for the computer.	

Ref	Component	Description	See Also
8	Keyboard	Serves as the data input device of the computer.	P.2-4
9	Fingerprint Sensor	Serves as the fingerprint verification, preventing unauthorized access to your computer.	P. 2-33
10	Stereo Speaker	Sends out sound and voice from the computer.	
11	Indicators	Show the current status of the computer's devices.	
	Power 	Lights green when computer is on.	P. 1-6
		Blinks green when computer is on Sleep mode.	
	Battery Charge 	Lights green when the battery is fully charged.	P. 3-3
		Lights amber when the battery is being charged.	
		Blinks red when the battery's capacity is below 10 %.	
		Blinks amber when the battery is in an abnormal condition.	
	WLAN 	Lights green when WLAN radio is on.	P. 2-23
Bluetooth 	Lights green when Bluetooth radio is on.	P. 2-25	
3G 	Lights green when 3G radio is on.	P. 2-29	

Bottom Components



Ref	Component	Description	See Also
1	Memory Slots	Inside are the memory slots for expanding the memory size of your computer.	P. 4-17

Closing Connector Covers

It is important to close the connector covers completely to ensure the waterproof integrity. Make sure to engage the locking mechanism if the cover is designed with such mechanism.

Chapter 2

Operating Your Computer

This chapter provides information about the use of the computer.

If you are new to computers, reading this chapter will help you learn the operating basics. If you are already a computer user, you may choose to read only the parts containing information unique to your computer.

CAUTION: The computer can get uncomfortably warm when you use it in high temperatures. As a safety precaution in such a circumstance, do not place the computer on your lap or touch it with your bare hands for extended periods of time. Prolonged body contact can cause discomfort and potentially a burn.

Starting and Stopping the Computer

There are a number of ways to start and stop the computer.

Starting the Computer

You always start the computer using the power button.

A computer starts up with an operating system (OS) existing on the storage device such as the hard disk. The computer will automatically load the OS after you turn it on. This process is called booting.

NOTE: An operating system is the platform for all your software application programs to run on. Your computer uses the Microsoft Windows operating system.

Stopping the Computer

When you finish a working session, you can stop the computer by turning off the power or leaving the computer in Sleep or Hibernation mode:

To stop in this mode...	Do this...	To start up or resume again
Off	Click Start → Shut Down This can prevent loss of unsaved data or damage to your software programs. If the system is locked up because of hardware or software problems, press the power button to turn off the computer.	Press the power button.

To stop in this mode...	Do this...	To start up or resume again
Sleep	Depending on your settings in Windows, you can place the computer in Sleep mode by: <ul style="list-style-type: none"> • Closing the display cover • Pressing the Fn+F12 hot key • Pressing the power button 	Press any key.
Hibernation	Depending on your settings in Windows, you can place the computer in Hibernation mode by: <ul style="list-style-type: none"> • Closing the display cover • Pressing the Fn+F12 hot key • Pressing the power button 	Press the power button.

If you choose to stop in Sleep or Hibernation mode, you can return to where you left off the next time you start up the computer. (See “Power Management” in Chapter 3 for more information.)

Using the Keyboard

Your keyboard has all the standard functions of a full-sized computer keyboard plus an **Fn** key added for specific functions.

The standard functions of the keyboard can be further divided into four major categories:

- Typewriter keys
- Cursor-control keys
- Numeric keys
- Function keys

Typewriter Keys

Typewriter keys are similar to the keys on a typewriter. Several keys are added such as the **Ctrl**, **Alt**, **Esc**, and lock keys for special purposes. When the lock keys (**Caps Lock** and **Num Lk**) are pressed, their corresponding indicators light up.

The Control (**Ctrl**) / Alternate (**Alt**) key is normally used in combination with other keys for program-specific functions. The Escape (**Esc**) key is usually used for stopping a process. Examples are exiting a program and canceling a command. The function depends on the program you are using.

Cursor-Control Keys

Cursor-control keys are generally used for moving and editing purposes.

NOTE: The word “cursor” refers to the indicator on the screen that lets you know exactly where on your screen anything you type will appear. It can take the form of a vertical or horizontal line, a block, or one of many other shapes.

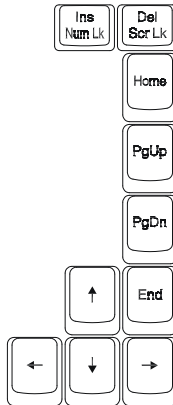

Numeric Keypad

A 15-key numeric keypad is embedded in the typewriter keys as shown next:

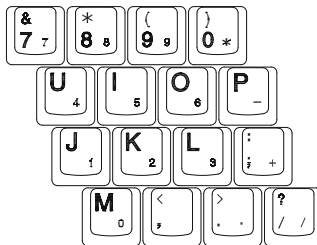

Numeric keys facilitate entering of numbers and calculations. When Num Lock is on, the numeric keys are activated; meaning you can use these keys to enter numerals.

NOTE:

- When the numeric keypad is activated and you need to type the English letter in the keypad area, you can turn Num Lock off or you can press **Fn** and then the letter without turning Num Lock off.
- Some software may not be able to use the numeric keypad on the computer. If so, use the numeric keypad on an external keyboard instead.

Function Keys

On the top row of the keys are the function keys: **F1** to **F12**. Function keys are multi-purpose keys that perform functions defined by individual programs.





Fn Key







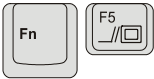
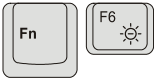

The **Fn** key, at the lower left corner of the keyboard, is used with another key to perform the alternative function of a key. The letter “Fn” and the alternative functions are identified by the color of blue on the keytop. To perform a desired function, first press and hold **Fn**, then press the other key.

Hot Keys



Hot keys refer to a combination of keys that can be pressed any time to activate special functions of the computer. Most hot keys operate in a cyclic way. Each time a hot key combination is pressed, it shifts the corresponding function to the other or next choice.



You can easily identify the hot keys with the icons imprinted on the keytop. The hot keys are described next.

Key	Description
	Switches the wireless LAN radio on and off.
	Switches the night vision feature on and off for viewing the display when using night vision goggles (optional).
	Decreases the sound volume.
	Increases the sound volume.

Key	Description
	<p>Switches the display output to one of the following when external devices are connected.</p> <p>Upon booting the system with CRT:</p> <pre> graph LR LCD --> CRT CRT --> LCD_CRT[LCD & CRT] LCD_CRT --> LCD </pre> <p>NOTE: This function only applies to Plug & Play display devices.</p>
	Decreases the LCD brightness.
	Increases the LCD brightness.
	Switches the touchscreen on and off (option).
	Switches the touchpad off and on.
	Switches the system sound output off (mute) and on.
	Switches the display on and off.
	Serves as the sleep button that you can define with Windows' Power Options .
	Switches the keyboard backlight on and off (option).

Windows Keys

The keyboard has two keys that perform Windows-specific functions:  Windows Logo key and  Application key.

The  Windows Logo key opens the **Start** menu and performs software-specific functions when used in combination with other keys. The  Application key usually has the same effect as a right mouse click. (See your Windows manual for more information.)

Using the Touchpad

CAUTION: Do not use a sharp object such as a pen on the touchpad. Doing so may damage the touchpad surface.

NOTE:

- Press **Fn+F9** to toggle the touchpad on or off.
- For optimal performance of the touchpad, keep your fingers and the pads clean and dry. When tapping on the pad, tap lightly. Do not use excessive force.

The touchpad is a pointing device that allows you to communicate with the computer by controlling the location of the pointer on the screen and making selection with the buttons.



The touchpad consists of a rectangular pad (work surface) and a left and right buttons. To use the touchpad, place your forefinger or thumb on the pad. The rectangular pad acts like a miniature duplicate of your display. As you slide your fingertip across the pad, the pointer (also called cursor) on the screen moves accordingly. When your finger reaches the edge of the pad,

simply relocate yourself by lifting the finger and placing it on the other side of the pad.

Here are some common terms that you should know when using the touchpad:

Term	Action
Point	Move your finger on the pad until the cursor points to the selection on the screen.
Click	Press and release the left button. –or– Tap gently anywhere on the pad.
Double-click	Press and release the left button twice in quick succession. –or– Tap twice on the pad rapidly.
Drag and drop	Press and hold the left button, then move your finger until you reach your destination (drag). Finally, release the button (drop) when you finish dragging your selection to the destination. The object will drop into the new location. –or– Gently tap twice on the pad and on the second tap, keep your finger in contact with the pad. Then, move your finger across the pad to drag the selected object to your destination. When you lift your finger from the pad, the selected object will drop into place.

Term	Action
Scroll	<p>To scroll is to move up and down or left and right in the working area on the screen.</p> <p>To move vertically, place your finger on the right or left edge of the pad and slide your finger up and down along the edge. To move horizontally, place your finger on the top or bottom edge of the pad and slide your finger left and right.</p> <p>This function works only after you install the touchpad driver supplied with the computer and it may not work for all applications.</p>

TABLE NOTE: If you swap the left and right buttons, “tapping” on the touchpad as an alternative method of pressing the left button will no longer be valid.

Configuring the Touchpad

You may want to configure the touchpad to suit your needs. For example, if you are a left-handed user, you can swap the two buttons so that you can use the right button as the left button and vice versa. You can also change the size of the on-screen pointer, the speed of the pointer, and so on.

To configure the touchpad, go to **Control Panel → Mouse Properties**.

Using the Touchscreen (Optional)

NOTE:

- Make sure the touchscreen driver has been installed properly.
- Press **Fn+F8** to toggle the touchscreen on or off.

CAUTION: Do not use a sharp object such as a ballpoint pen or pencil on the touchscreen. Doing so may damage the touchscreen surface. Use your finger or the included stylus.

The touchscreen is a touch-sensitive device that allows you to navigate on the screen without using a keyboard, touchpad, or mouse.



Use the included stylus to select objects on the screen. The pen can be stretched for better grip and handling.



Here are some common terms that you should know when using the touchscreen:

Term	Action
Click/Point	Tap gently on the touchscreen.
Double-click	Tap twice on the touchscreen rapidly.
Drag and drop	Press lightly on the touchscreen and move your finger until you reach your destination (drag). Finally, release your finger (drop) when you finish dragging your selection to the destination. The object will drop into the new location.

Using the Quick Buttons



Located on top of the keyboard are four quick buttons:

Button	Description
P1	<p>Turns off/on the LCD display and LED indicators by default, or Starts a pre-defined program. (See “P1 Quick Launch Key Utility” in Chapter 6 for information.)</p> <p>NOTE: The function of P1 button depends on your setting in BIOS Setup program under the Advanced menu (see chapter 5 for details).</p>
	<p>Enables/disables power saving when using battery power. In power saving mode, the system turns down the panel backlight and sacrifices processing speed to gain more battery life. The button lights green when power saving mode is enabled.</p> <p>NOTE: The button works only when using battery power.</p>
	<p>Enables/disables sunlight readable display. The button lights green while sunlight readable mode is enabled.</p>
	<p>Enables/disables light sensor. When enabled, your computer automatically adjusts the LCD brightness based on the surrounding lighting condition. The button lights green while light sensor is enabled.</p>

Using the Hard Disk Drive

Your computer comes with a removable 2.5-inch PATA (parallel ATA) / SATA (serial ATA) hard disk drive.

Select models come with a heater that automatically turns on for low temperature operation.

CAUTION:

- Make regular backups of your data files from your hard disk drive to USB flash disks or other storage media.
- Never try to remove or install the hard disk drive while the computer is powered on. Doing so can result in loss of data, and can damage the computer and the hard disk drive's sensitive circuitry.
- Never turn off or reset the computer while the hard disk drive in-use indicator is on.

Installing a Second Hard Disk Drive (Optional)

You can install a second hard disk drive to your computer. To install a second hard disk drive:

1. Make sure that system power is off.
2. Open the media bay cover by sliding the release latch towards the left.



3. Press upward the release latch (❶) and carefully pull on the ribbon strip (❷) to remove the drive.



4. With the ribbon strip facing outward, insert the hard disk drive all the way into the compartment.



5. Close the media bay cover to secure the hard disk drive.

Using the DVD Drive (Optional)

Your computer comes with a Super Multi drive. The drive can read from and write to CD, DVD+, DVD- and DVD-RAM media.

CAUTION:

- When inserting a disc, do not use force.
- Make sure that the disc is correctly inserted into the tray, and then close the tray.
- Do not leave the drive tray open. Also, avoid touching the lens in the tray with your hand. If the lens becomes dirty, the drive may malfunction.
- Do not wipe the lens using materials with rough surface (such as paper towel). Instead, use a cotton swab to gently wipe the lens.

FDA regulations require the following statement for all laser-based devices: "Caution, Use of controls or adjustments or performance of procedures other than those specified herein may result in hazardous radiation exposure."

NOTE: The DVD drive is classified as a Class 1 laser product. This label is located on the DVD drive.



CLASS 1 LASER PRODUCT
LASER KLASSE 1

NOTE: For DVD and Combo drives only.

This product incorporates copyright protection technology that is protected by method claims of certain U.S. patents and other intellectual property rights owned by Macrovision Corporation and other rights owners. Use of this copyright protection technology must be authorized by Macrovision Corporation, and is intended for home and other limited viewing uses only unless otherwise authorized by Macrovision Corporation. Reverse engineering or disassembly is prohibited.

Inserting and Removing a Disc

Follow this procedure to insert or remove a disc:

1. Turn on the computer.
2. Open the media bay cover by sliding the release latch towards the left.



3. Press the eject button and the DVD tray will slide out partially. Gently pull on it until it is fully extended.
4. To insert a disc, place down the disc in the tray with its label facing up. Slightly press the center of the disc until it clicks into place.

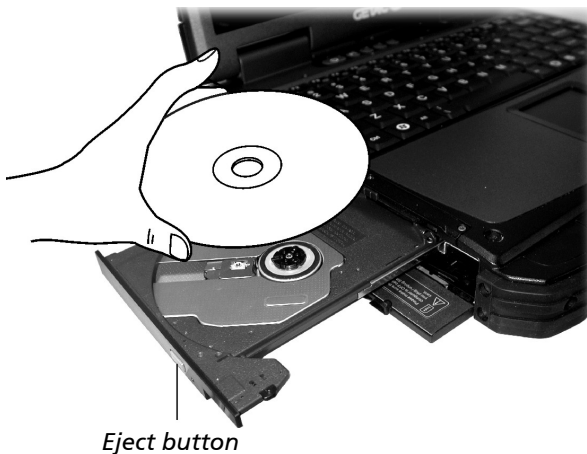

To remove a disc, hold the disc by its outer edge and lift it up from the tray.

5. Gently push the tray back into the drive.
6. Close the media bay cover.

NOTE: In the unlikely event that you are unable to release the drive tray by pressing the eject button, you can manually release the disc. (See “Optical Drive Problems” in Chapter 8.)

Using the Network Features

Using the Modem

The internal 56 K fax/data modem allows you to use the telephone line to communicate with others by fax, email, or connect to an online service or bulletin board.

To connect the telephone line to the modem, connect one end of the modem cable to the RJ-11 connector on the computer and the other end to the phone line.



NOTE:

- When using the communication software, you may have to disable power management.
- Set the COM port of the modem to COM3.
- Set parameters such as modem speed (baud rate) and line type (pulse dialing or tone dialing).
- Do not enter the Sleep mode when using the communication software.

Using the LAN

The internal 10/100/1000Base-T LAN (Local Area Network) module allows you to connect your computer to a network. It supports data transfer rate up to 1000 Mbps.

To connect the network cable to the LAN module, connect one end of the LAN cable to the RJ-45 connector on the computer and the other end to the network hub.



Using the Wireless LAN

Depending on your model, an internal mini PCI-E wireless LAN (WLAN) card may have been pre-installed by your computer manufacturer at the factory. This card allows you to access corporate networks or the Internet in a wireless environment.

The WLAN features include:

- Peer-to-Peer (Ad-Hoc) and Access Point (Infrastructure) modes support
- WEP (Wired Equivalent Privacy) 64/128-bit data encryption
- IEEE 802.11a/b/g/n standard compliance

Technology	Stated Maximum Throughput (Mbps)	Data Rates (Mbps)	Band (GHz)	Modulation Technology
802.11a	54	54, 48, 36, 24, 18, 12, 9, 6	5.15 ~ 5.35	OFDM (Orthogonal Frequency Division Multiplexing)
802.11b	11	11, 5.5, 2, 1	2.412 ~ 2.462	DSSS (Direct Sequence Spread Spectrum)
802.11g	54	54, 36, 18, 9	2.4	OFDM (Orthogonal Frequency Division Multiplexing)
802.11n	100 Mbps or more	100 ~ 210	2.4 / 5	Spatial multiplexing, uses MIMO (multiple-input multiple-output)

NOTE: 802.11g mode is backward compatible with 802.11b mode.

If your WLAN card was provided by your dealer instead of the computer manufacturer, contact your dealer for the correct driver to use.

Turning On/Off the WLAN Radio

NOTE: The FAA (Federal Aviation Agency) has deemed it unsafe to operate wireless devices in aircraft as this may interfere with flight safety. Remember to turn off wireless LAN when using your computer in the airplane.

To turn on the WLAN radio:

1. Make sure that the RF switch is at the **ON** position.





2. Press **Fn+F1** to turn on the WLAN radio (see “Hot Keys” in Chapter 2), indicated by the WLAN indicator () glowing in green when on.

If you need to temporarily turn off the radio, press **Fn+F1**. To resume network connection, press **Fn+F1** again.

It takes approximately 30 seconds for your computer to make a successful WLAN connection and approximately 10 seconds to disconnect.

Connecting to a Wireless Network

To connect to a wireless network:

1. Make sure that the WLAN radio is on (as described in the previous section) and **Windows Mobility Center** has **Wireless Network** turned on (accessed from **Windows Control Panel**).
2. Tap the Wireless Network icon  on the taskbar. (An orange light in the icon  indicates connections are available.)

3. In the list of available wireless networks, tap a network, and then tap **Connect**.



4. Some networks require a network security key or passphrase. To connect to one of those networks, ask your network administrator or Internet service provider (ISP) for the security key or passphrase.

For more information on setting a wireless network connection, refer to Windows online help.

Using the Bluetooth Feature

Depending on your model, your computer may incorporate the Bluetooth capability for short-range (about 10 meters) wireless communications between devices without requiring a cable connection.

With Bluetooth wireless technology, data can be transmitted through walls, pockets and briefcases as long as two devices are within range.

Turning On/Off the Bluetooth Radio

1. Make sure that the RF switch is at the **ON** position.



2. Right-click the Getac Utility icon () located on Windows taskbar and select **Quick Bar**. (You need to tap  on the taskbar to show the hidden icons.)

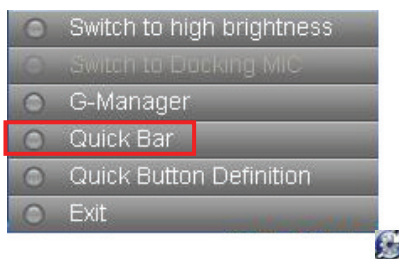





3. The following appears onscreen. To turn on the Bluetooth feature, click the Bluetooth quick button.



The Bluetooth indicator () will glow in green. By default, your computer is in the general discoverable and pairable mode after the Bluetooth feature is turned on.



4. To turn off the Bluetooth feature, click the Bluetooth quick button again.

The status of the Bluetooth connection is indicated by the Bluetooth icon located in the taskbar. (You need to tap  on the taskbar to show the hidden icons.)

Status	Icon
Off	 (blue with red logo)
On	 (blue with white logo).
Connected	 (blue with green logo)

You can use the Bluetooth Utility to configure Bluetooth wireless connection settings and transfer files.

Connecting to another Bluetooth Device

1. Make sure that the target Bluetooth device is turned on, discoverable and within close range. (See the documentation that came with the Bluetooth device.)
2. Double-click the Bluetooth icon  on the taskbar and click **New Connection**.
Or, right-click the  icon, and then click **Add New Connection** from the shortcut menu.

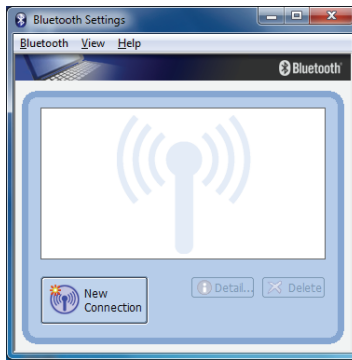

3. The **Add New Connection Wizard** window appears. Select **Express Mode (Recommended)**, and then click **Next**.



4. Select the device to connect to and click **Next**.

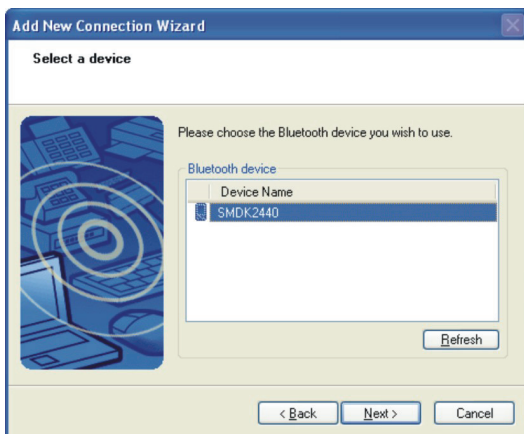

5. Depending on the type of Bluetooth device that you want to connect to, you will need to enter the pertinent information.

For detailed information on using the Bluetooth Utility, right-click the  icon and then click **Help** from the shortcut menu.

Using the 3G Feature (Optional)

3G is the third generation of mobile phone standards and technology after 2G. Services include wide-area wireless voice telephony and broadband wireless data, all in a mobile environment.

Unlike IEEE 802.11 networks, 3G networks are “wide area cellular telephone networks” which evolved to incorporate high-speed internet access and video telephony. IEEE 802.11 networks are short range, high-bandwidth networks primarily developed for data.

NOTE:

- Your model only supports data transmission, voice transmission is not supported.
- When using the wireless modem feature, pull out the 3G antenna.



Installing a SIM Card

To use the 3G feature to connect to the Internet, you need to subscribe to 3G service and acquire a SIM card from the service provider. To install the SIM card, follow these steps:

1. Turn off the computer and disconnect the AC adapter.
2. Open the media bay cover by sliding the release latch towards the left.



3. Press upward the release latch (❶) and carefully pull the ribbon strip (❷) to slide the existing device out of the media bay.



4. Carefully place your computer upside down and locate the SIM card slot.

5. Insert the SIM card into the holder. Make sure the beveled corner on the SIM card is facing towards the slot and that the golden contact area on the card is facing downwards.

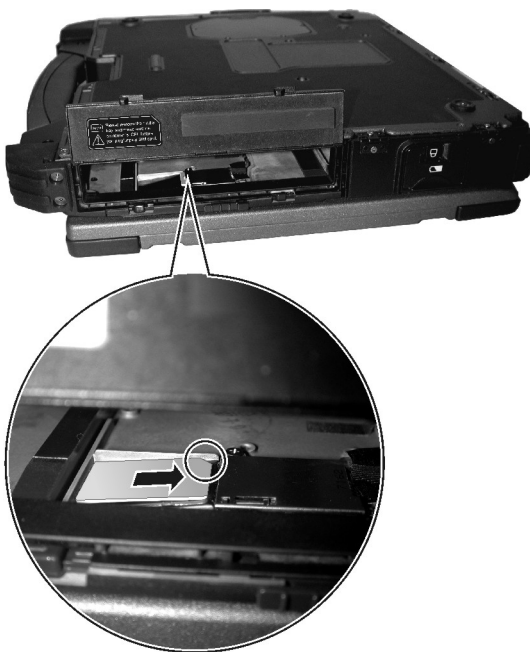

6. Replace the media bay device.
7. Close the media bay cover.

NOTE: To remove the SIM card, push inward to release and slide the SIM card out of the slot.

Turning On/Off the 3G Radio

1. Make sure that the RF switch is at the **ON** position.



2. Right-click the Getac Utility icon (🌐) located on Windows taskbar and select **Quick Bar**. (You need to tap  on the taskbar to show the hidden icons.)

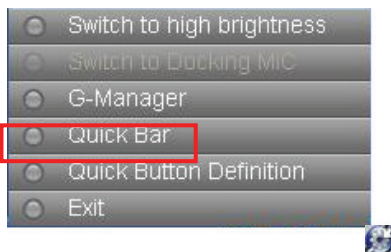

3. The following appears onscreen. To turn on the 3G feature, click the 3G quick button.



The 3G indicator (📶) will glow in green.

4. To turn off the 3G feature, click the 3G quick button again.

You can use the 3G software application to configure 3G connection settings.

Using the Fingerprint Sensor

The fingerprint sensor provides a strong authentication mechanism based on fingerprint recognition.

WARNING:

- To protect the fingerprint sensor, be sure to slide close the cover when not using the fingerprint reader.
- We shall not be liable for any loss or damage whatsoever resulting from your use of the fingerprint sensor or neglect of fingerprint sensor use, or any data loss resulting from such developments as fingerprint authentication malfunctioning.

To set up the fingerprint sensor:

1. Locate and slide open the fingerprint sensor cover.



NOTE: You can enroll fingerprints only after setting a password for the Windows user account.

2. Go to **Start** menu → **Programs** → **Protector Suite 2009**.

3. The following screen appears. Enter your Windows password and click **Submit**.

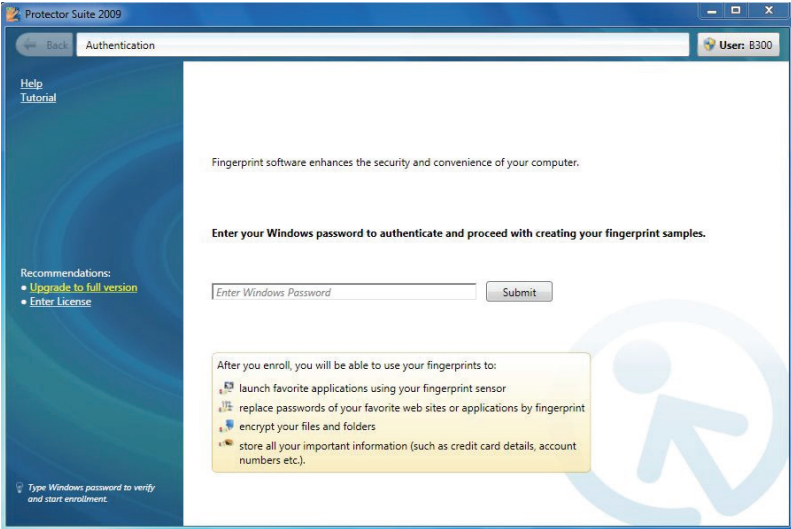

4. Use Control Center utility to enroll your fingerprints.

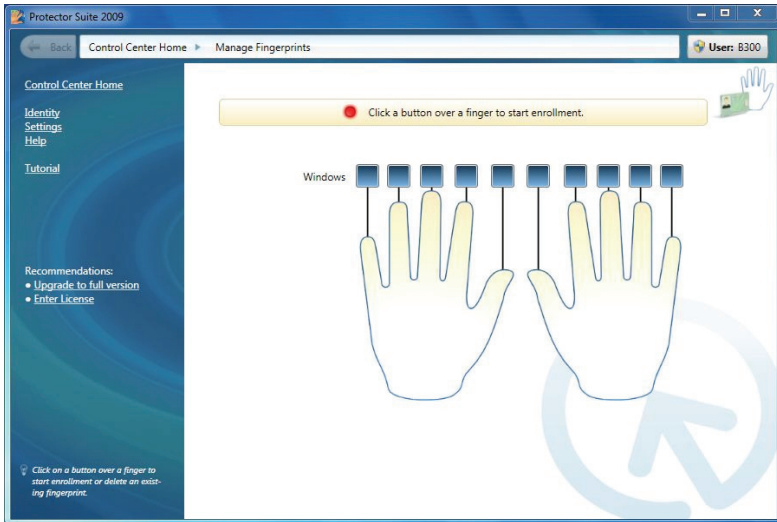

5. Follow the onscreen instructions to complete enrolling your fingerprint(s).



NOTE: For detailed information, access the program's online Help or Tutorial.

Chapter 3

Managing Power

Your computer operates either on external AC power or on internal battery power.

This chapter tells you how you can effectively manage power. To maintain optimal battery performance, it is important that you use the battery in the proper way.

AC Adapter

CAUTION:

- The AC adapter is designed for use with your computer only. Connecting the AC adapter to another device can damage the adapter.
- The AC power cord supplied with your computer is for use in the country where you purchased your computer. If you plan to go overseas with the computer, consult your dealer for the appropriate power cord.
- When you disconnect the AC adapter, disconnect from the electrical outlet first and then from the computer. A reverse procedure may damage the AC adapter or computer.
- When unplugging the connector, always hold the plug head. Never pull on the cord.



The AC adapter serves as a converter from AC (Alternating Current) to DC (Direct Current) power because your computer runs on DC power, but an electrical outlet usually provides AC power. It also charges the battery pack when connected to AC power.

The adapter operates on any voltage in the range of 100~240 V AC.

Battery Pack

The battery pack is the internal power source for the computer. It is rechargeable using the AC adapter.

The operating time of a fully charged battery pack depends on how you are using the computer. When your applications often access peripherals, you will experience a shorter operating time.

NOTE: Care and maintenance information for the battery is provided in the “Battery Pack Guidelines” section in Chapter 7.

Charging the Battery Pack

NOTE:

- Charging will not start if the battery’s temperature is below 0 °C (32 °F) or above 30 °C (86 °F).
- The charging process will stop and the Battery Charge Indicator flashes green and yellow by turns when the battery’s temperature gets above 60 °C (140 °F). If this happens, the battery pack may be damaged. Please contact your dealer.
- During charging, do not disconnect the AC adapter before the battery has been fully charged; otherwise you will get a prematurely charged battery.

To charge the battery pack, connect the AC adapter to the computer and an electrical outlet. The Battery Charge Indicator () on the computer glows amber to indicate that charging is in progress. You are advised to keep the computer power off while the battery is being charged. When the battery is fully charged, the Battery Charge Indicator lights green.

The charging times are as follows:

Battery Type	Charging Time	
	Computer is Off	Computer is On and in Idle State
6-cell (4 A)	2.5~3.5 hours	3.0~4.3 hours
9-cell (4 A)	3.5~4.5 hours	4.0~6.0 hours

CAUTION: After the computer has been fully recharged, do not immediately disconnect and reconnect the AC adapter to charge it again. Doing so may damage the battery.

NOTE: The battery level may automatically lessen due to the self-discharge process (0.21 % per day), even when the battery pack is fully charged (100 %). This happens no matter if the battery pack is installed in the computer.

Initializing the Battery Pack

You need to initialize a new battery pack before using it for the first time or when the actual operating time of a battery pack is much less than expected.



Initializing is the process of fully charging, discharging, and then charging. It can take several hours.

1. Make sure that the computer power is turned off. Connect the AC adapter to fully charge the battery pack.
2. After the battery pack is fully charged, turn on the computer. When the message "Click mouse or press <Enter> for Menu" appears, click the touchpad's left button or press the Enter key to invoke the program.
3. A small window appears, select **Launch System Setup**.
4. Disconnect the AC adapter and leave the computer on until the battery is fully discharged. The computer will shut down automatically.
5. Connect the AC adapter to fully charge the battery pack.

Checking the Battery Level

NOTE: Any battery level indication is an estimated result. The actual operating time can be different from the estimated time, depending on how you are using the computer.

By Operating System

You can check the approximate battery level using the battery meter function of the operating system. To read the battery level in Windows, click the battery icon ( when running on battery power or  when running on external power) on the taskbar.

By Gas Gauge

On the exterior side of the battery pack is a gas gauge for displaying the estimated battery charge. When the battery pack is not installed in the computer and you want to know the battery charge, you can press the switch with a pointed device to see the corresponding value of indicator segment that light green.



The value of the corresponding green segment indicates the relative percentage of the battery charge. The battery pack is fully discharged when you see no segment glowing green.

Replacing the Battery Pack

CAUTION:

- There is danger of explosion if the battery is incorrectly replaced. Replace the battery only with the computer manufacturer's optional battery packs. Discard used batteries according to the dealer's instructions.
- Do not attempt to disassemble the battery pack.

If you often rely on battery power for a long period of time while traveling, you may consider the purchase of an additional battery pack from your dealer and keep it with you in a fully charged state as a backup.

To replace the battery pack, follow these steps:

1. Turn off the computer and disconnect the AC adapter.
2. Locate the battery compartment on the left side of the computer.
3. Slide the cover lock to the left (❶) and then lift the release latch (❷) to open the compartment cover.



4. Pull the ribbon strip and slide the battery pack out of the compartment.



5. With the ribbon strip facing outward, insert the new battery pack all the way into the compartment.
6. Close the cover, press the release latch downward to engage, and then slide the lock towards the right to secure the cover.

Installing a Second Battery Pack (Optional)

You can install a second battery pack to your computer for a longer operating time when AC power is not available. To install a second battery pack:

1. Turn off the computer and disconnect the AC adapter.
2. Open the media bay cover by sliding the release latch towards the left.



3. Press upward the release latch (1) and carefully pull the ribbon strip (2) to slide the existing device out of the media bay.



4. With the ribbon strip facing outward, insert the second battery pack all the way into the media bay.



5. Close the media bay cover.

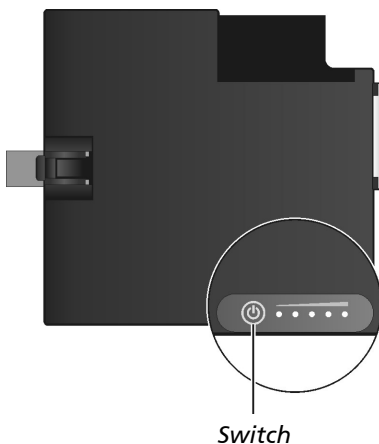

On the exterior side of the second battery pack is a gas gauge for displaying the estimated battery charge. When the battery pack is not installed in the computer and you want to know the battery charge, you can press the switch with a pointed device to see the corresponding value of indicator segment that light green.



The value of the corresponding green segment indicates the relative percentage of the battery charge. The battery pack is fully discharged when you see no segment glowing green.

Battery Low Signals and Actions

The battery icon  changes appearance to display the current state of the battery.

Battery Icon	Battery Level	Description
	Discharging	The icon shows the charge remaining in 10-percent increments until the charge reaches the low-battery level.
	Low	The battery charge has reached the low-battery level (10% by default).
	Critically low	The battery charge has reached the critical battery level (5% by default). By default, Windows will display a notification and put your computer into Hibernation.

When the battery is low, the computer's Battery Charge Indicator () also blinks red to alert you to take actions.

Always respond to low-battery by connecting the AC adapter, placing your computer in Hibernation mode, or turning off the computer.

Power Management

Your computer supports ACPI (Advanced Configuration and Power Interface) for power management. The power management feature allows you to reduce the power consumption for energy saving.

With an ACPI-compliant operating system such as Windows, power supply to different computer components is controlled on an as-needed basis. This allows maximum power conservation and performance at the same time.

In general, Windows' power management works in this way:

What...	When...
Power to the hard disk is turned off	When the hard disk has been idle for a set period.
Power to the display is turned off	When the display has been idle for a set period.
The Tablet PC enters the Sleep mode. The hard disk and display are turned off and the entire system consumes less power.	When the entire system has been idle for a set period.
	When you manually activate the mode.
The Tablet PC enters the Hibernation mode. (See the next subsection for more information.)	When the entire system has been idle for a set period.
	When you manually activate the mode.

For detailed information on power management, see Windows' Help.

Hibernation

Hibernation is a very useful feature. People frequently open many applications when they use computers. It takes some time to get all these applications open and running, and normally they all have to be closed before the computer can be turned off.

When you use the hibernation feature, you do not have to close the applications. The computer stores the state of your computer to a file on the hard disk and then shuts down. The next time you turn on your computer, you return to exactly where you left off.

Power-Saving Tips

Aside from enabling your computer's power saving mode (see previous section), you can do your part to maximize the battery's operating time by following these suggestions.

- Press the power saving quick button (**ECO**) to enter into power saving mode when using battery power.
- Do not disable Power Management.
- Decrease the LCD brightness to the lowest comfortable level.
- Shorten the length of time before Windows turn off the display.
- Many USB devices use power just by being connected. If you use a USB mouse, you can save power by disconnecting the mouse and using the touchpad. If you use a USB flash drive, unplug it when you are not using it.
- If you work with an application that uses a PC card, exit the application when you finish using it.
- Remove the card (such as PC card and Smart Card) if not using it.
- Turn off the wireless radio if you are not using the wireless module (such as WLAN, Bluetooth, or 3G).
- Turn off the computer when you are not using it.

Chapter 4

Expanding Your Computer

You can expand the capabilities of your computer by connecting other peripheral devices. When using a device, be sure to read the instructions accompanying the device together with the relevant section in this chapter.

Connecting a VGA or HDMI Display Monitor

If you want the benefits of a larger display screen with higher resolution, you can connect an external display monitor to your computer.

Your computer supports a VGA connector and a HDMI connector. HDMI (High-Definition Multimedia Interface) is an audio/video interface that transmits uncompressed digital data and therefore delivers true HD quality. As a home theater system most likely includes a widescreen HDTV and surround-sound system, you can use the home theater system to view/play media stored on your computer by connecting via the HDMI interface.

Follow this procedure to connect an external monitor:

1. Turn off the computer.
2. Slide the release latch towards the right to open the connector cover.



3. Depending on the type of your monitor, plug the monitor's signal connector to the computer's VGA or HDMI connector.





4. Plug one end of the monitor's power cord into the power socket on the monitor and the other end to an electrical outlet.
5. To use the monitor, turn on the monitor before turning on the computer.
6. The connected device should respond by default. If not, you can switch the display output by pressing the **Fn+F5** hot keys. (You can also change the display through Windows **Control Panel** → **Display Settings Properties**.)

CAUTION: Do not disconnect the external monitor while the computer is in the Sleep mode or Hibernation mode. If no external monitor is connected when the computer resumes, the LCD might not display properly.

Connecting a Serial Device

Your computer has two serial ports for connecting a serial device such as a serial mouse or serial communication device (modem).

Follow this procedure to connect a serial device:

1. Turn off the computer.
2. Slide the release latch towards the right to open the port cover.



3. Plug the device cable to the serial port on the rear of the computer.

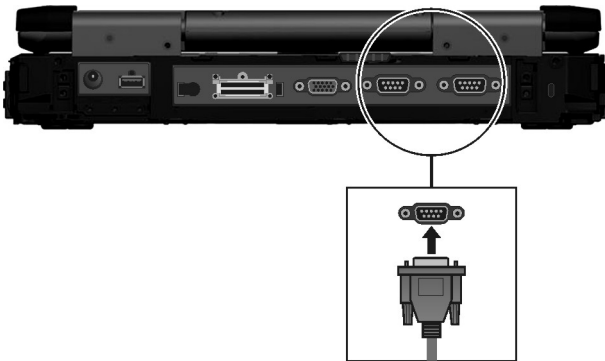

4. Turn on the computer.

NOTE: Portable modems that derive power through the serial port cannot be used with the computer. Instead, use a modem that is powered by its own internal battery or external AC power.

Connecting a USB Device

Your computer has two USB ports for connecting USB devices, such as a digital camera, scanner, printer, modem, and mouse.

NOTE: The eSATA/USB Combo port can also function as a USB port.

The USB ports support transfer rates up to 12 MB/s for USB 1.1 devices and 480 MB/s for USB 2.0 devices.

To connect a USB device, slide the release latch towards the right to open the port cover and then simply plug the device cable to one of the USB ports.

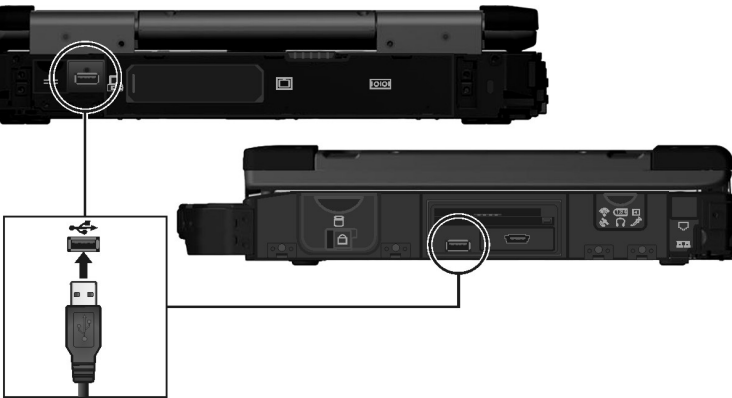

Connecting an eSATA Device

Your computer has an eSATA/USB combo port for connecting eSATA devices (such as an external hard drive and external optical drive) / USB devices (see previous section).

The port supports SATA II with transfer rate up to 3.0Gbit/s. It can provide 5V power if a certified USB-eSata combo cable is used.

To connect an external eSATA device, simply plug the device cable to the eSATA port.

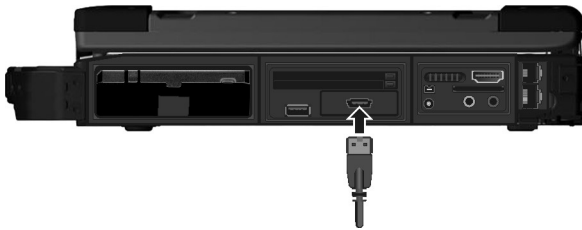

Connecting an IEEE 1394 Device

Your computer has a mini IEEE 1394 port for connecting IEEE 1394 devices that include not only computer peripheral devices such as scanner, printer and high-quality CCD, but also consumer electronic equipment such as DVCAM and VCR.

To connect an IEEE 1394 device, prepare an IEEE 1394 cable. Slide the release latch towards the right to open the connector cover. Then plug the appropriate end of the cable to the computer's mini IEEE 1394 connector and the other end to the device's corresponding connector.



Connecting Audio Devices

For higher audio quality, you can send or receive sound through external audio devices.

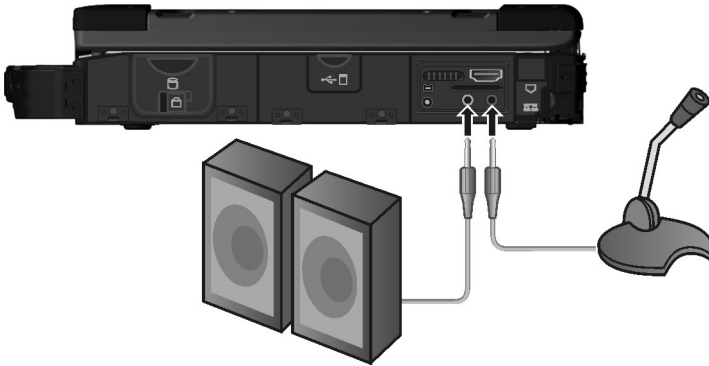

NOTE: After connecting an external audio device, make sure that you specify the use of the correct audio device in Windows.

- **Audio Output Connector** (green) can be connected to speakers, headphones, or earphone set.
- **Microphone Connector** (pink) can be connected to an external microphone for recording voice or sound.

NOTE: When using the external speakers/headphones or microphone, you cannot use the internal one.

Using Smart Cards (Optional)

Depending on the model, your computer has a smart card slot.

With an embedded microcontroller, smart cards have the unique ability to store large amounts of data, carry out their own on-card functions (e.g., encryption and mutual authentication), and interact intelligently with a smart card reader.

To insert a smart card:

1. Locate the smart card slot on the right of the computer and open the cover.
2. Slide the smart card, with its label and embedded computer chip facing down into the slot.



3. When a new card is seated, use the third-party smart card software to allow your computer to read it.

To remove a smart card:

1. Make sure that the third-party smart card software is not accessing the smart card.
2. Pull the card out of the slot.

Using PC Cards

Depending on your model, your computer has one or two PC card slots which supports type II card and CardBus specifications.

NOTE:

- Some PC cards require additional system resources. Before using such PC card, you may have to free other system resources for the PC card.
- Although some PC cards can be inserted and removed without turning off the computer, you cannot remove or install PC cards during Sleep mode.

To insert a PC card:

1. Locate the PC card slot(s) on the right side of the computer and open the cover.
2. Slide the PC card, with its label facing up, into the slot until the eject button pops out.

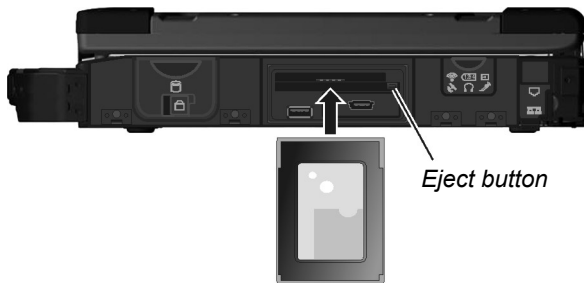

3. When a new card is seated, the computer will detect it and try to install the appropriate driver. Follow the on-screen instructions to complete the process.

To remove a PC card:

1. Double-click on the **Safely Remove Hardware**  icon found on the Windows taskbar and the **Safely Remove Hardware** window appears on screen.
2. Select (highlight) the PC card from the list to disable the card.
3. Push the eject button and the card will slide out slightly.
4. Pull the card out of the slot.

Using ExpressCards (Optional)

Depending on the model, your computer has an ExpressCard slot.

ExpressCard supports the PCI Express and USB 2.0 serial data interfaces (supporting speeds of up to 2.5 Gbps and 480 Mbps respectively), improving speed in data transfer while conserving power usage.

The ExpressCard slot can accommodate a 54 mm (ExpressCard/54) or 34 mm (ExpressCard/34) wide ExpressCard. Typical ExpressCards support a very extensive range of applications including memory, wired and wireless communication cards, and security devices.

Shown next are the appearances of ExpressCards for your reference.

ExpressCard/54



ExpressCard/34



To insert an ExpressCard:

1. Locate the ExpressCard slot on the right side of the computer and open the cover.
2. Slide the ExpressCard, with its label facing up, all the way into the slot until the rear connectors click into place.

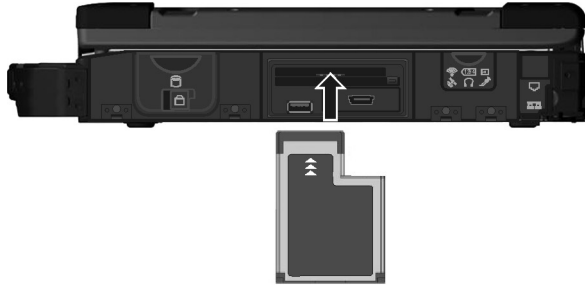

3. When a new card is seated, the computer will detect it and try to install the appropriate driver. Follow the on-screen instructions to complete the process.

To remove an ExpressCard:

1. Double-click on the **Safely Remove Hardware**  icon found on the Windows taskbar and the **Safely Remove Hardware** window appears on screen.
2. Select (highlight) the ExpressCard from the list to disable the card.
3. Push the eject button and the card will slide out slightly.
4. Pull the card out of the slot.



Using the MMC/SD Card Reader

NOTE:

- If your hard disk is divided into several drives, make sure that all drives have been formatted before using the Card Reader. Otherwise, you may encounter problems when using the Card Reader.
- You can use only storage cards. Your Card Reader does not support cards with I/O (input/output) functions such as a wireless network card or Bluetooth card.

Your computer has a Card Reader. The Card Reader is a small drive for reading from and writing to removable storage cards (or called memory cards). The Card Reader supports the MultiMediaCard (MMC) and Secure Digital (SD) cards.

Shown next are the appearance and size of each card type for your reference.

Type	MMC Card	SD Card
Appearance		
Size	24×32×1.4 (mm)	24×32×2.1 (mm)

To insert a storage card:

1. Locate the Card Reader slot on the right side of the computer and open the cover.
2. Align the card with its connector pointing to the slot and its label facing down. Slide the card into the slot until it reaches the end.



3. Windows will detect the card and assign it a drive name.

To remove a storage card:

1. Double-click **My Computer**.
2. Right-click the drive with the card and select **Eject**.
3. Pull the card out of the slot.

Using the Port Replicator (Optional)

A port replicator is available as an option. This device eliminates the hassles of having you connect and disconnect the various cables when carrying your computer around and allows a variety of peripherals to be connected including a headphone or microphone, etc. The port replicator connects to the expansion bus connector at the rear of your computer.

1. Slide open the expansion bus connector cover.



2. Connect your port replicator to the expansion bus connector ().



For more detailed information, refer to the Operating Instructions of the port replicator.

CAUTION:

- Hot/warm docking and hot/warm undocking are not possible with the port replicator.
- Contact your dealer for the correct type of port replicator (docking input device) to connect to the expansion bus connector of your computer.

System Memory Upgrade

You can upgrade your computer by changing system memory to a maximum of 4 GB on the two 533/667 MHz DDRII SO-DIMM slots.

CAUTION: RAM modules are extremely sensitive to static electricity. There are cases where static electricity generated by the human body has adversely affected such modules. When inserting or removing a RAM module, do not touch the terminals or internal components, insert objects other than the module, or allow foreign particles to enter. Doing so has been known to cause damage, fire, or electrical shock.

To install the RAM module:

1. Remove the battery pack (see chapter 3).
2. Carefully place the computer upside down.
3. Remove the six screws to open the compartment cover.

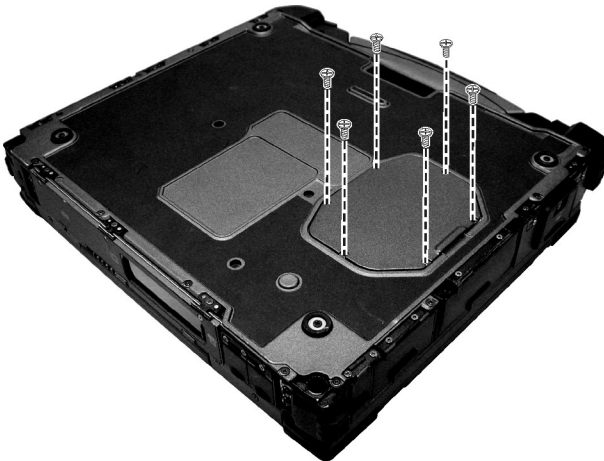

4. To install the RAM module, match the module's notched part with the socket's projected part and firmly insert the module into the socket at a

20-degree angle (❶). Then push down until the retaining clips lock the module into position (❷).

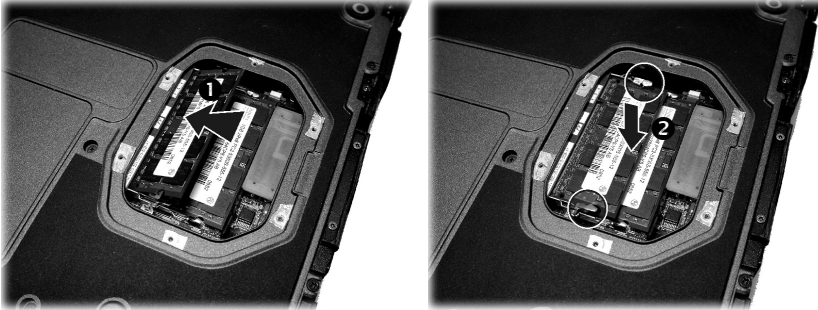

CAUTION: If the RAM module is difficult to insert or difficult to push down, do not force it. Check once more to ensure that the module is positioned correctly.

5. Close the compartment cover and secure with six screws.

Chapter 5

Using BIOS Setup and System Recovery

BIOS Setup Utility is a program for configuring the BIOS (Basic Input/ Output System) settings of the computer. BIOS is a layer of software, called firmware, that translates instructions from other layers of software into instructions that the computer hardware can understand. The BIOS settings are needed by your computer to identify the types of installed devices and establish special features.

System Recovery reinstalls Windows to your system and configures it to the system's factory default settings.

This chapter tells you how to use the BIOS Setup and System Recovery.

BIOS Setup

When and How to Use

You need to run BIOS Setup Utility when:

- You see an error message on the screen requesting you to run BIOS Setup Utility.
- You want to restore the factory default BIOS settings.
- You want to modify some specific settings according to the hardware .
- You want to modify some specific settings to optimize the system performance.

To run BIOS Setup Utility, press the **F2** key when the prompt appears on the screen during system startup. The prompt shows up on the screen for only a few seconds. You must press **F2** quickly. The BIOS Setup Utility main screen appears as shown next.

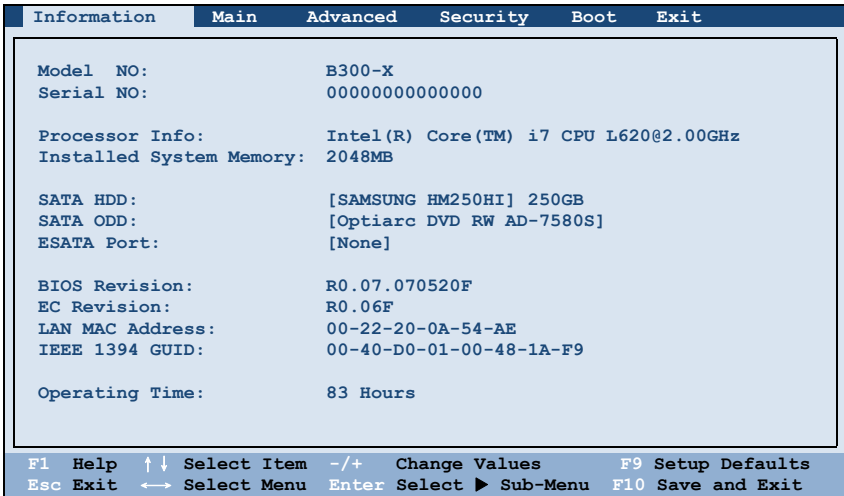

Use the keyboard to move around and make selections. Keyboard information can be found at the bottom of the screen.

NOTE:

- The BIOS Setup Utility screens shown in this chapter are for your reference only. The actual items or settings on your computer may differ.
- The BIOS Setup Utility program may have been updated after the publication of this manual.
- The settings you select in your operating system might override similar settings in BIOS Setup Utility.

Information Menu

The Information menu contains the basic configuration information of the system. There are no user-definable items in this menu.

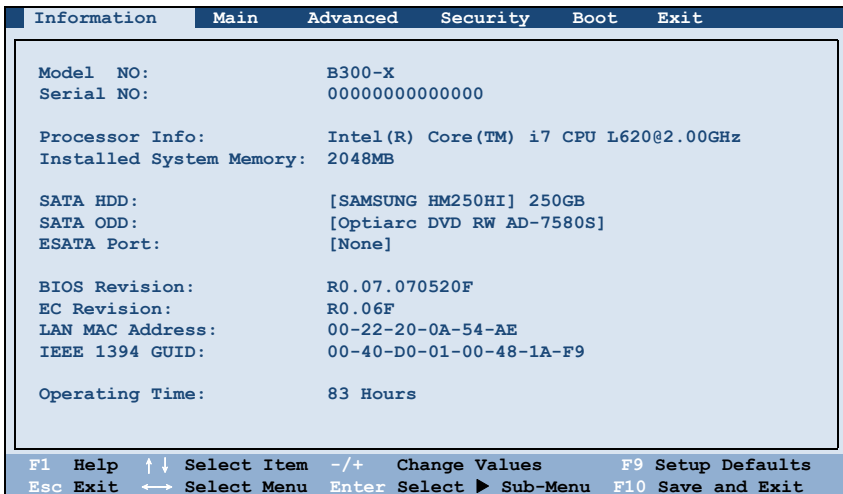

Main Menu

The Main menu contains the various system settings.

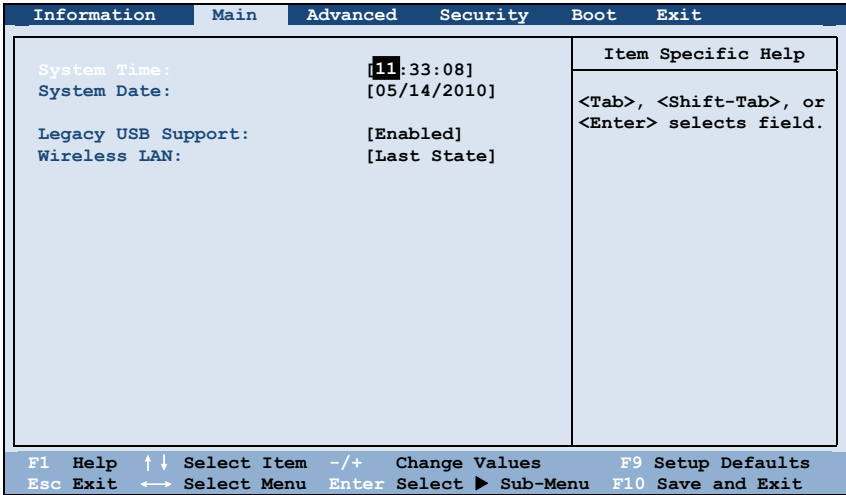

System Time sets the system time.

System Date sets the system date.

Legacy USB Support enables or disables the system's support for Legacy USB device in DOS mode.

Wireless LAN setting this item to *Off* will start the system with wireless radio off, *On* will start the system with the wireless radio on, and *Last State* will start the system based on the state of wireless radio during your last power off.

Advanced Menu

The Advanced menu contains the advanced settings.

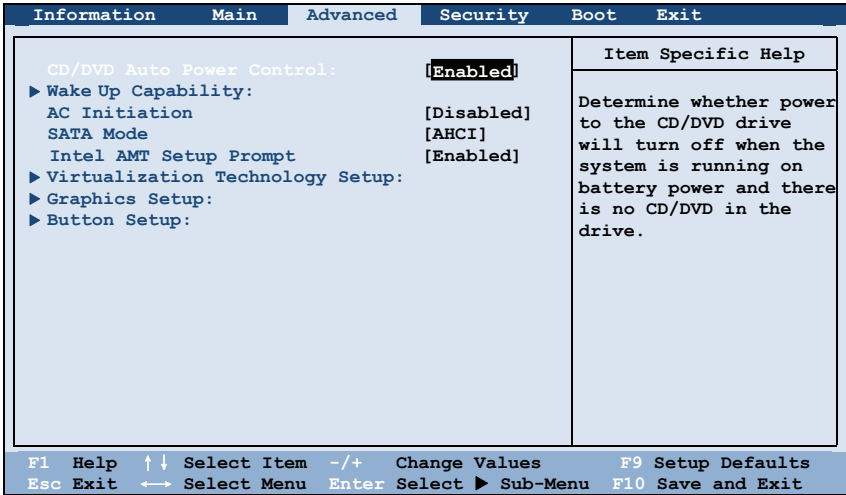

CD/DVD Auto Power Control enables or disables the power control to the CD/DVD driver. When enabled, the power to the CD/DVD drive will turn off when the system is running on battery power and there is no CD/DVD in the drive.

Wake Up Capability specifies events for waking up the system from S3 (Sleep) state. Press **Enter** to access the submenu as shown below.

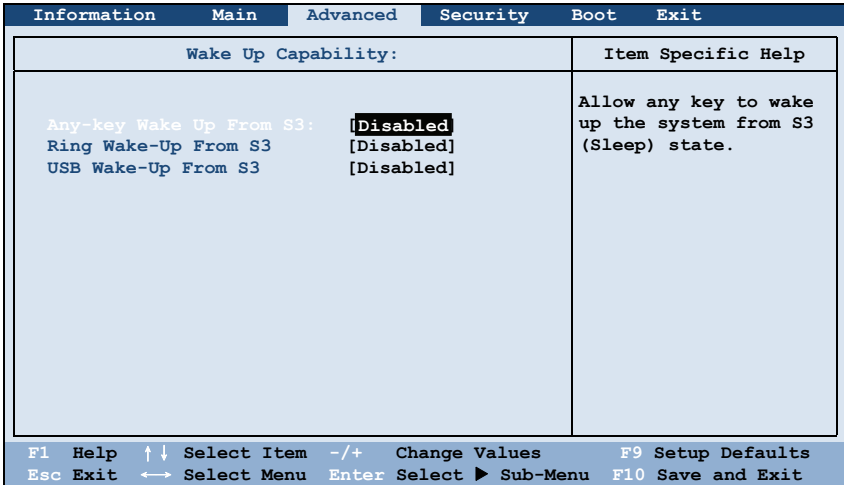

Any-key Wake Up From S3 allows any key to wake up the system from S3 (Sleep) state.

Ring Wake-Up From S3 allows a modem activity to wake up the system from S3 (Sleep) state.

USB Wake-Up From S3 allow a USB device activity to wake up the system from S3 (Sleep) state.

AC Initiation sets if connecting AC power will automatically start or resume the system.

SATA Mode set to *AHCI* if your hard disk supports AHCI. AHCI allows you to take advantage of Advanced Host Controller Interface features. The options are *IDE* and *AHCI*.

CAUTION: Incorrect SATA mode settings can result in hard disk drive boot failure.

Intel AMT Setup Prompt determines whether the prompt for entering Intel AMT Setup appears or not during POST. If disabled, users cannot enter Intel AMT Setup.

Virtualization Technology Setup sets Virtualization Technology parameters. Press **Enter** to access the submenu as shown below.

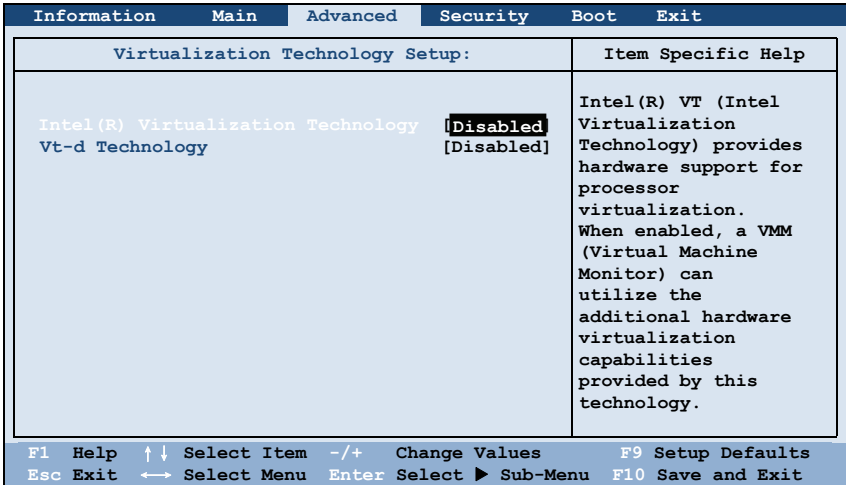

Intel(R) Virtualization Technology enables or disables Intel® VT (Intel Virtualization Technology) feature which provides hardware support for processor virtualization. When enabled, a VMM (Virtual Machine Monitor) can utilize the additional hardware virtualization capabilities provided by this technology.

Vt-d Technology enables or disables VT-d (Intel® Virtualization Technology for Directed I/O). When enabled, VT-d helps enhance Intel platforms for efficient virtualization of I/O devices.

Graphics Setup sets graphics related options. Press **Enter** to access the submenu as shown below.

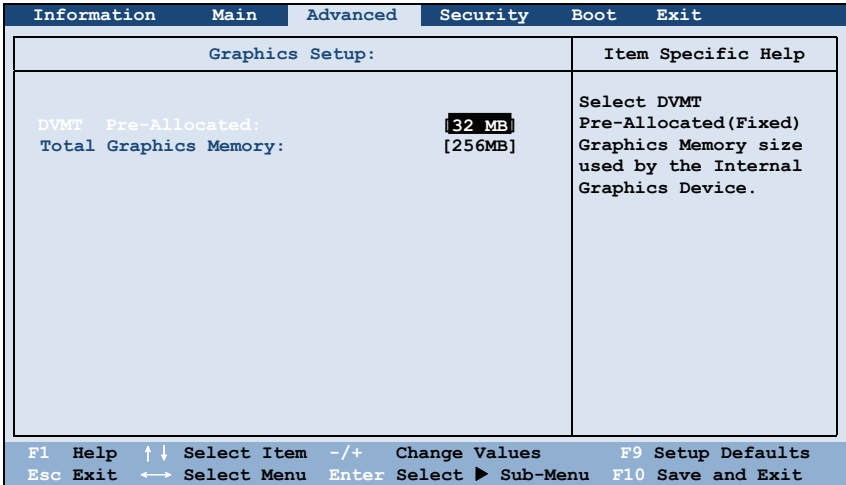

DVMT Pre-Allocated sets the amount of pre-allocated (fixed) graphics memory for use by the internal graphics device.

Total Graphics Memory sets the amount of total graphics memory (pre-allocated + fixed + DVMT) for use by the internal graphics device.

Button Setup sets hardware button related options. Press **Enter** to access the submenu as shown below.

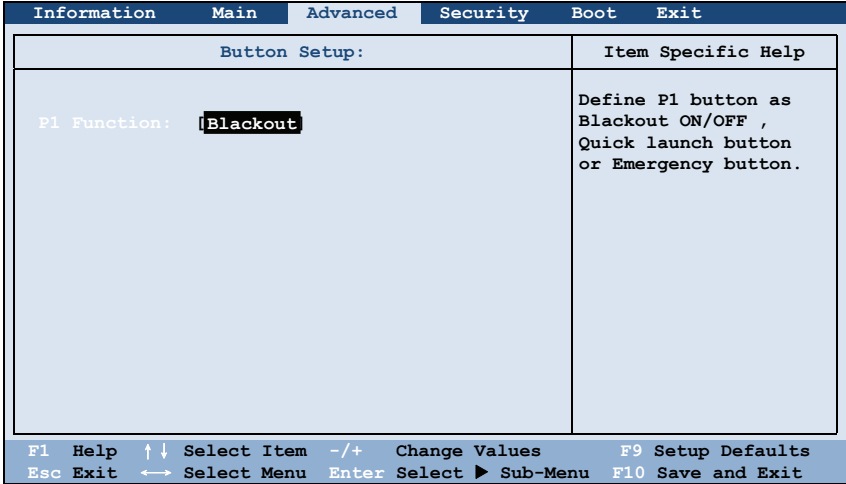

P1 Function specifies the **P1** quick button function. When set to *Blackout*, the **P1** quick button allows you to turn off the LCD backlight and LED indicator. When set to *Quick Btn*, the **P1** quick button functions as a user customized quick launch key.

Security Menu

The Security menu contains the security settings, which safeguard your system against unauthorized use.

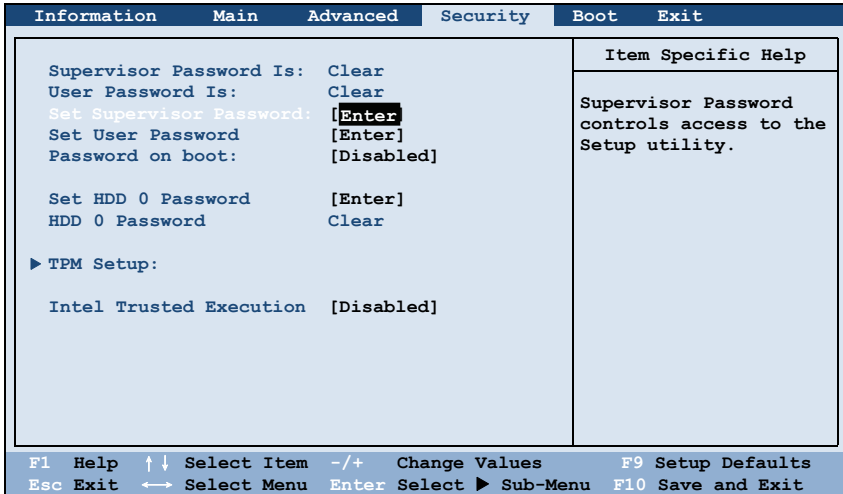

NOTE:

- You can set the user password only when the supervisor password has been set.
- If both the administrator and user passwords are set, you can enter any of them for starting up the system and/or entering BIOS Setup. However, the user password only allows you to view/change the settings of certain items.
- A password setting is applied right after it is confirmed. To cancel a password, leave the password empty by pressing the **Enter** key.

Supervisor/User Password Is shows whether you have set the supervisor/user password or not for the system.

Set Supervisor/User Password sets the supervisor/user password. When typing the password, first make sure that Num Lock is off, and then type the password in the entry fields and press **Enter**. Confirm your password by

typing it again and pressing **Enter**. You can set the supervisor/user password to be required for starting up the system and/or entering BIOS Setup.

Password on Boot allows you to enable or disable the entering of password for booting up your system. Once the password is successfully set and this item is enabled, it is required for booting up the system.

Set HDD 0 Password sets the password for locking the Primary Master hard disk drive. After setting a password, the hard disk drive can only be unlocked by the password no matter where it is installed.

HDD 0 Password Is shows whether you have set the hard disk password or not.

TPM Setup sets various TPM parameters. Press **Enter** to access the submenu as shown below.

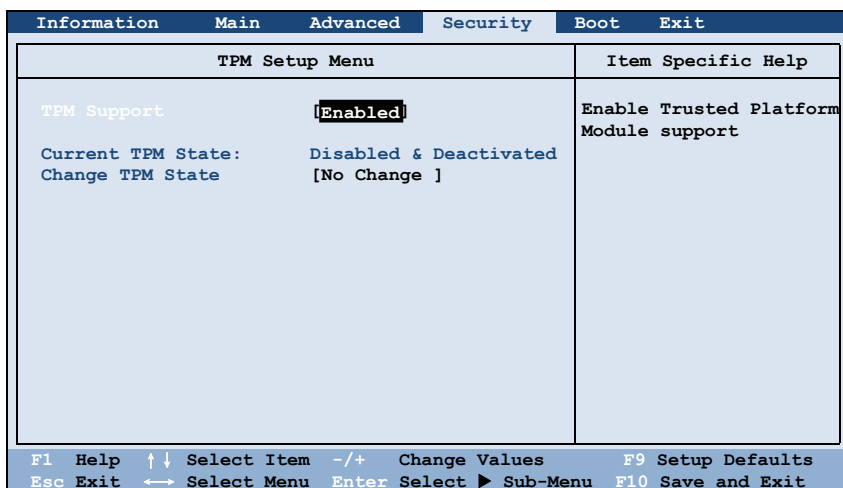

TPM Support enables or disables TPM support (see chapter 6 for details).

Current TPM State shows the current TPM state.

Change TPM State allows you to select between *No Change*, *Clear*, *Deactivate & Disable*, and *Enable & Activate*.

Intel Trusted Execution enables or disables utilization of additional hardware capabilities provided by Intel Trusted Execution Technology.

Boot Menu

The Boot menu sets the sequence of the devices to be searched for the operating system.

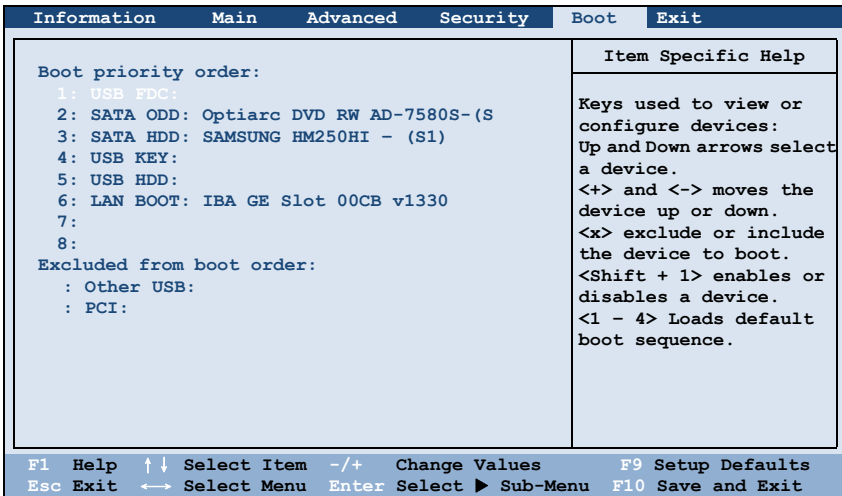

The bootable devices will be automatically detected during POST and shown here, allowing you to set the sequence that the BIOS uses to look for a device from which to load the OS. Below is a brief description of keyboard usage:

Key	Function
↑, ↓	Selects (highlight) a boot device.
+, -	Changes the boot sequence.
1 to 4	Loads the default boot sequence.
f or r	Specifies if the boot device is fixed (f) or removable (r).

Key	Function
X	Moves the highlighted boot device from the "Boot priority order" list to the "Excluded from boot order" list, and vice versa.
Shift+F1	Deactivates/activates the highlighted boot device on the "Boot priority order" list. When a device has been deactivated, an "!" (exclamation) symbol appears beside the item and system will bypass it when detecting boot device during POST.

Exit Menu

The Exit menu displays ways of exiting BIOS Setup Utility. After finishing with your settings, you must save and exit so that the changes can take effect.

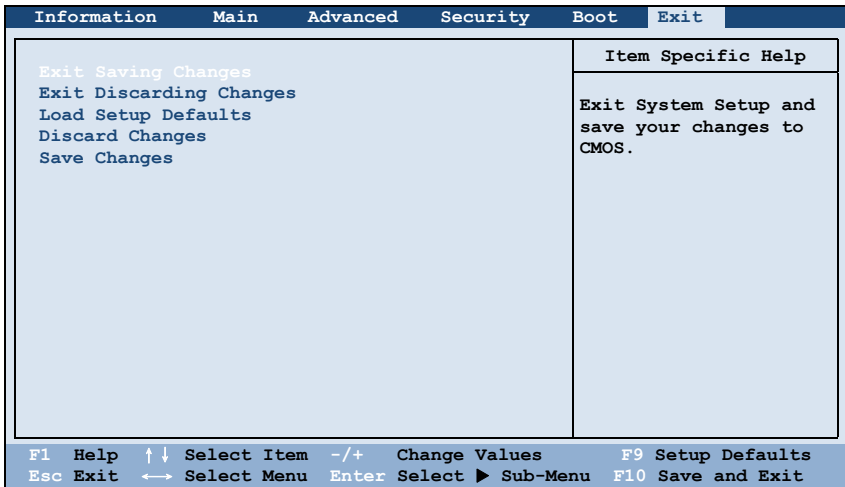

Exit Saving Changes saves the changes you have made and exits BIOS Setup Utility.

Exit Discarding Changes exits BIOS Setup Utility without saving the changes you have made.

Load Setup Defaults loads the factory default values for all the items.

Discard Changes restores the previous values for all the items.

Saves Changes saves the changes you have made.

System Recovery

You need to run System Recovery when:

- Your Windows operating system does not start at all.
- You want to restore the factory default Windows settings.

WARNING: Using this feature will reinstall Windows to your system and configure it to the system's factory default settings. All data on the hard disk drive will be lost.

To run System Recovery:

1. During system startup when the following screen appears, press **Ctrl + Alt + F2** keys for four seconds or press **Enter** and select **HDI Recovery** when a small window appears on the screen.

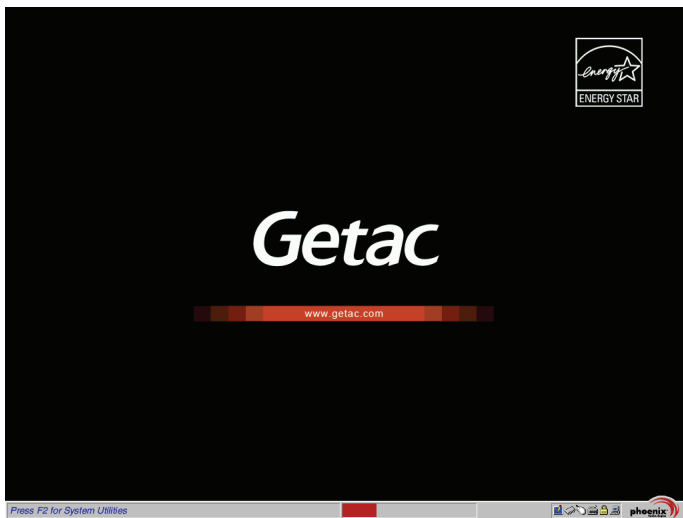

2. The message **This will help you reinstall Windows to the whole HDD to factory default. All data on HDD will be lost** appears on the screen to ask if you want to access System Recovery. Type **1** to continue or type **0** to exit.

3. A warning message appears as follows:

You must accept the following terms before performing the recovery process:

1. The recovery software is solely the purpose of reinstalling or restoring software associated with the hard disk of this operating Getac machine.

2. Except the above, no other use is granted hereunder.

(1)Yes, I agree to the provisions of this agreement and wish to continue.

(0)No, I do not agree to the provisions of this agreement and do not wish to continue.

Type 1 to continue.

4. Type 1 again when the message Are you sure you want to recover now?

(1)Yes (0)No appears onscreen. The following screen appears:

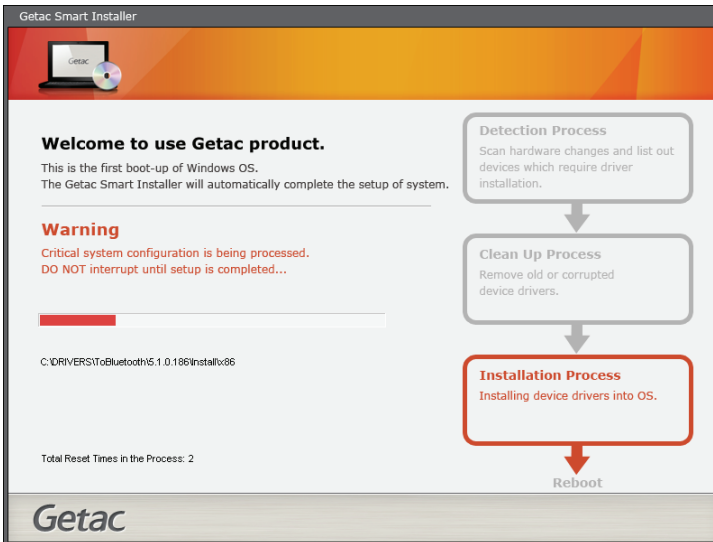

5. Your system will start the recovery process and Windows operating system will be re-installed to its default setting.

Chapter 6

Using the TPM and P1 Utility

Your computer comes with an added security feature known as the TPM (Trusted Platform Module) – a component on your computer’s mainboard that is specifically designed to enhance platform security above-and-beyond the capabilities of today’s software by providing a protected space for key operations and other security critical tasks.

Also, located on top of your keyboard is the **P1** quick launch key. The quick launch key utility allows you to re-define (customize) the **P1** quick launch key according to your needs.

This chapter describes how to use these utilities.

Using TPM (Trusted Platform Module)

TPM is a hardware-based security feature that can be used to create and manage computer-generated digital certificates. When combined with security software, the TPM enhances existing network and computer security by enabling features such as file protection capabilities and protected e-mail.

NOTE:

- Make sure you select *Enable* on the **TPM Support** item under the **Security** menu of your BIOS Setup (see chapter 5 for details).
- Make sure you select *Enable & Activate* on the **Change TPM State** item under the **Security** menu of your BIOS Setup (see chapter 5 for details).
- You only need to activate these items once.

You can use the certificates to:

- Send and receive secure email from email clients like Microsoft Windows Mail/Outlook Express, Microsoft Outlook or Netscape Messenger
- Set up browser (e.g. Netscape Navigator or Internet Explorer) and web server (e.g. Microsoft Internet Information Server) for Client Authentication
- Sign Microsoft Word macros
- Encrypt files and folders
- Secure network connections

NOTE: For information on using the program and the different security features, click **Start → All Programs → Infineon Security Platform Solution → Help**.

P1 Quick Launch Key Utility

If you select *Quick Btn* in BIOS Setup program on the **P1 Function** item under the Advanced menu (see chapter 5 for details), you can use the quick launch key utility that allows you to define the **P1** quick launch key.

To start the utility, right-click the Getac utility icon () and select **Quick Buttons Definition** on the Windows taskbar. The **Quick Button Definition** window appears as shown next.

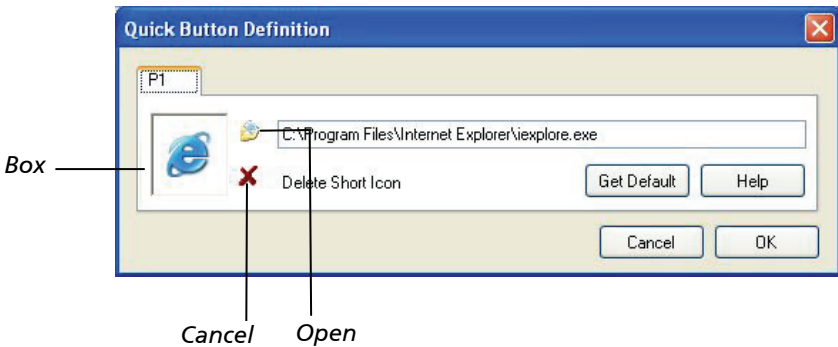

Defining the buttons:

The box in the window represents the user-definable button.

To assign a program to a button, click the **Open**  icon to pop up the **Select a File to Open** dialog box as shown next and select the desired program. Then, click **Open** to complete the process.

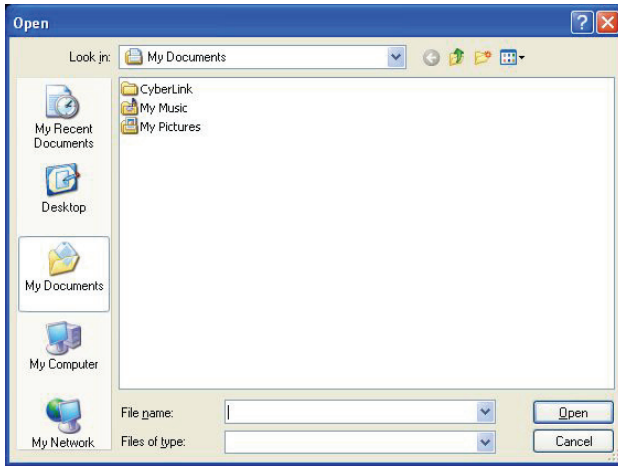

The appropriate icon will then appear in the box. To launch the program, press the **P1** quick launch key, or, if the **Quick Button Definition** window is open, click the box containing the icon.

Chapter 7

Caring for the Computer

Taking good care of your computer will ensure a trouble-free operation and reduce the risk of damage to your computer.

This chapter gives you guidelines covering areas such as protecting, storing, cleaning, and traveling.

Protecting the Computer

To safeguard the integrity of your computer data as well as the computer itself, you can protect the computer in several ways as described in this section.

Using an Anti-Virus Strategy

You can install a virus-detecting program to monitor potential viruses that could damage your files.

Using Windows Action Center

Windows Action Center alerts you to take action on the following security essentials:

- Windows Firewall
- Windows Update
- Malware Protection (anti-virus, anti-spyware)
- Others (Internet security, user account control)

For detailed information on Windows Security Center, see *Windows' Help*.

Using the Cable Lock

You can use a Kensington-type cable lock to protect your computer against theft. The cable lock is available in most computer stores.

To use the lock, loop the lock cable around a stationary object such as a table. Insert the lock to the Kensington lock hole and turn the key to secure the lock. Store the key in a safe place.



Taking Care of the Computer

Location Guidelines

- For optimal performance, use the computer where the recommended temperature is between 0 °C (32 °F) and 55 °C (131 °F) – actual operating temperature depending on product specifications.
- Avoid placing the computer in a location subject to high humidity, extreme temperatures, mechanical vibration, direct sunlight, or heavy dust.
- Do not cover or block any ventilation openings on the computer. For example, do not place the computer on a bed, sofa, rug, or other similar surface. Otherwise, overheating may occur that results in damage to the computer.
- Keep the computer at least 13 cm (5 inches) away from electrical appliances that can generate a strong magnetic field such as a TV, refrigerator, motor, or a large audio speaker.
- Avoid moving the computer abruptly from a cold to a warm place. A temperature difference of more than 10 °C (18 °F) may cause condensation inside the unit, which may damage the storage media.
- Do not place the computer on an unsteady surface.

General Guidelines

- Do not place heavy objects on top of the computer when it is closed as this may damage the display.
- The screen surface is easily scratched. Do not use paper towels to clean the display but use the included soft cloth. Avoid touching it with your fingers, pen, or pencil.
- To maximize the life of the backlight in the display, allow the backlight to automatically turn off as a result of power management. Avoid using

a screen saver or other software that prevents the power management from working.

Cleaning Guidelines

- Never clean the computer with its power on.
- Use a soft cloth moistened with water or a non-alkaline detergent to wipe the exterior of the computer.
- Gently wipe the display with a soft, lint-free cloth. Do not use alcohol or detergent on the display.
- Dust or grease on the touchpad can affect its sensitivity. Clean the pad by using adhesive tape to remove the dust and grease on its surface.

Battery Pack Guidelines

- Recharge the battery pack when it is nearly discharged. When recharging, make sure that the battery pack is fully charged. Doing so may avoid harm to the battery pack.
- The battery pack is a consumable product and the following conditions will shorten its life:
 - when frequently charging the battery pack
 - when using, charging, or storing the battery in high temperature condition
- To avoid hastening the deterioration of the battery pack thereby prolonging its useful life, minimize the number of times you charge it so as not to frequently increase its internal temperature.
- Charge the battery pack between 10 °C ~ 30 °C (50 °F ~ 86 °F) temperature range.
A higher environment temperature will cause the battery pack's temperature to rise. Avoid charging the battery pack inside a closed vehicle and in hot weather condition.
Also, charging will not start if the battery pack is not within the allowed temperature range.

- It is recommended that you do not charge the battery pack more than once a day.
- It is recommended that you charge the battery pack with the computer's power off.
- To maintain the battery pack's operating efficiency, store it in a cool dark place removed from the computer and with 30 % ~ 40 % charge remaining.
- Important guidelines when using the battery pack.

When installing or removing the battery pack take note of the following:

- avoid installing or removing the battery pack when the computer is in Sleep mode. Abruptly removing the battery pack may cause loss of data or the computer may become unstable.
- avoid touching the battery pack terminals or damage may occur, thereby causing improper operation to it or the computer.

The computer's input voltage and surrounding temperature will directly affect the battery pack's charge and discharge time:

- charging time will be prolonged when the computer is turned on. To shorten the charging time, it is recommended that you place the computer in sleep or hibernation mode.
- a low temperature will prolong the charging time as well as hasten the discharge time.

Touchscreen Guidelines

- Use the finger or the included stylus on the display. Using a sharp or metallic object other than your finger or stylus may cause scratches and damage the display, thereby causing errors.
- Avoid using excessive force that may cause damage to the display.
- Use a soft cloth to remove dirt on the display. The touchscreen surface has a special protective coating that prevents dirt from sticking to it. Not using a soft cloth may cause damage to the special protective coating on the touchscreen surface.

To remove hard to remove dirt, blow some steam on the particular area and gently wipe away using a soft cloth.

- Turn off the computer power when cleaning the display. Cleaning the display with the power on may cause improper operation.
- Use the touchscreen within the intended area only. The display area and touchscreen operating area is the same. Using it beyond the allowed area may cause damage to the display and result in improper operation.
- Do not use excessive force on the display. Avoid moving the computer while holding the display or twisting the display. Avoid placing objects on top of the display as this may cause the glass to break thereby damaging the display.
- Using the touchscreen during low temperature (less than 5 °C) may cause a slower response time, this is normal. A normal response time may be restored upon returning to room temperature.
- When there is noticeable discrepancy in the operation of the touchscreen function (wrong location on intended operation or improper display resolution), refer to the Windows online Help for instructions on recalibrating the touchscreen display.

When Traveling

- Before traveling with your computer, make a backup of your hard disk data into flash disks or other storage devices. As an added precaution, bring along an extra copy of your important data.
- Make sure that the battery pack is fully charged.
- Make sure that the computer is turned off and the top cover is securely closed.
- Make sure that all the connector covers are closed completely to ensure the waterproof integrity.
- Do not leave objects in between the keyboard and closed display.
- Disconnect the AC adapter from the computer and take it with you. Use the AC adapter as the power source and as a battery-charger.
- Hand-carry the computer. Do not check it in as luggage.
- If you need to leave the computer in the car, put it in the trunk of the car to avoid exposing the computer to excessive heat.
- When going through airport security, it is recommended that you send the computer and flash disks through the X-ray machine (the device you set your bags on). Avoid the magnetic detector (the device you walk through) or the magnetic wand (the handheld device used by security personnel).
- If you plan to travel abroad with your computer, consult your dealer for the appropriate AC power cord for use in your country of destination.

Chapter 8

Troubleshooting

Computer problems can be caused by hardware, software, or both. When you encounter any problem, it might be a typical problem that can easily be solved.

This chapter tells you what actions to take when solving common computer problems.

Preliminary Checklist

Here are helpful hints to follow before you take further actions when you encounter any problem:

- Try to isolate which part of the computer is causing the problem.
- Make sure that you turn on all peripheral devices before turning on the computer.
- If an external device has a problem, make sure that the cable connections are correct and secure.
- Make sure that the configuration information is properly set in the BIOS Setup program.
- Make sure that all the device drivers are correctly installed.
- Make notes of your observations. Are there any messages on the screen? Do any indicators light? Do you hear any beeps? Detailed descriptions are useful to the service personnel when you need to consult one for assistance.

If any problem persists after you follow the instructions in this chapter, contact an authorized dealer for help.

Solving Common Problems

Battery Problems

The battery does not charge (Battery Charge indicator does not light amber).

- Make sure that the AC adapter is properly connected.
- Make sure that the battery is not too hot or cold. Allow time for the battery pack to return to room temperature.
- Make sure that the battery pack is installed correctly.
- Make sure that the battery terminals are clean.

The operating time of a fully charged battery becomes shorter.

- If you often partially recharge and discharge, the battery might not be charged to its full potential. Initialize the battery to solve the problem. (See “Initializing the Battery Pack” in Chapter 3 for instructions.)

The battery operating time indicated by the battery meter does not match the actual operating time.

- The actual operating time can be different from the estimated time, depending on how you are using the computer. If the actual operating time is much less than the estimated time, initialize the battery. (See “Initializing the Battery Pack” in Chapter 3 for instructions.)

Bluetooth Wireless Transmission Problems

I cannot connect to another device with Bluetooth wireless technology.

- Make sure that the Bluetooth wireless card is correctly installed.
- Make sure that both devices have activated Bluetooth feature.

- Make sure that the distance between the two devices are not over 10 meters or that there are no walls or other obstructions between the devices.
- Make sure that the other device is not in “Hidden” mode.
- Make sure that both devices are compatible.

Display Problems

Nothing appears on the screen.

- During operation, the screen may automatically turn off as a result of power management. Press any key to see if the screen comes back.
- The brightness level might be too low. Increase brightness by pressing the **Fn+F7** hot key.
- The display output might be set to an external device. To switch the display back to the LCD, press the **Fn+F5** hot key or change the display through the **Display Settings** Properties.

The characters on the screen are dim.

- Adjust the brightness and/or contrast.

Bad dots appear on the display at all times.

- A small number of missing, discolored, or bright dots on the screen are an intrinsic characteristic of TFT LCD technology. It is not regarded as a LCD defect.

The external monitor displays nothing.

- Make sure that the monitor is turned on.
- Make sure that the monitor’s signal cable is properly connected.
- Switch the display to the monitor by pressing the **Fn+F5** hot key or change the display through the **Display Settings** Properties.

Simultaneous display/multi-display does not work.

- Make sure that you turn on the external monitor before turning on the computer.

- Press the **Fn+F5** hot key to toggle through the display options or change the **Display Settings Properties** in Windows.

ExpressCard Problems

The ExpressCard does not work.

- Make sure that the ExpressCard is correctly seated.
- If the card requires an IRQ (Interrupt ReQuest), make sure that there is one available.

The ExpressCard stops communicating properly.

- The application may have been reset when the computer is turned off or in Sleep mode. Exit and restart the application.

Hardware Device Problems

The computer does not recognize a newly installed device.

- The device may not be correctly configured in the BIOS Setup program. Run the BIOS Setup program to identify the new type.
- Make sure if any device driver needs to be installed. (Refer to the documentation that came with the device.)
- Make sure if the device needs any jumper or switch settings. (Refer to the documentation that came with the device.)
- Check the cables or power cords for correct connections.
- For an external device that has its own power switch, make sure that the power is turned on.

Hard Disk Drive Problems

The hard disk drive error message appears on the screen.

- The hard disk drive has defects. Ask your dealer for help.

The hard disk drive operations seem slow.

- The data files stored on the hard disk drive may be fragmented. Use a tool such as Window's **Disk Defragmenter** to defragment the files.

The hard disk drive in-use indicator glows without blinking.

- The data files stored on the hard disk drive may be fragmented. Use a tool such as Window's **Disk Defragmenter** to defragment the files.

Keyboard, Mouse, and Touchpad Problems

The keyboard does not respond.

- Try connecting an external keyboard. If it works, contact an authorized dealer, as the internal keyboard cable might be loose.

Water or liquid is spilt into the keyboard.

- Immediately turn off the computer and unplug the AC adapter. Then turn the keyboard upside down to drain the liquid out of the keyboard. Make sure to clean up any part of the spill you can get to. Though the keyboard of your computer is spill-proof, liquid will remain in the keyboard enclosure if you don't remove it.

The numeric keypad is disabled.

- Make sure that the **Num Lock** is switched on. (Check if the Num Lock Indicator  glows or not.)

The external keyboard does not work.

- Make sure that the keyboard cable is properly connected.

The USB mouse does not work.

- Make sure that the mouse cable is properly connected.

The touchpad does not work, or the pointer is difficult to control with the touchpad.

- Make sure that the touchpad is clean.

LAN Problems

I cannot access the network.

- Make sure that the LAN cable is properly connected to the RJ-45 connector and the network hub.
- Make sure that the network configuration is appropriate.
- Make sure that the user name or password is correct.

Modem Problems

The modem does not work.

- Make sure that the telephone line is properly connected.
- Make sure that the COM port in the communication software is correctly set.
- Turn off power management.

DVD Drive Problems

The DVD drive cannot read a disc.

- Make sure that the disc is correctly seated in the tray, with the label facing up.
- Make sure that the disc is not dirty. Clean the disc with a disc cleaning kit, available in most computer stores.
- Make sure that the computer supports the disc or the files contained.

You cannot eject a disc.

The disc is not properly seated in the drive. Manually release the disc following the method described next:

1. Turn off the computer.
2. Open the media bay cover by sliding the release latch towards the left.



3. Insert a small rod, such as a straightened paperclip, into the drive's manual eject hole and push firmly to release the tray.



4. Pull the tray out until fully extended, and then remove the disc.

PC Card Problems

The PC card does not work.

- Make sure that the PC card is correctly seated.
- If the card requires an IRQ (Interrupt ReQuest), make sure that there is one available.

The PC card stops communicating properly.

- The application may have been reset when the computer is turned off or in Sleep mode. Exit and restart the application.

Power Management Problems

The computer does not enter Sleep or Hibernation mode automatically.

- If you have a connection to another computer, the computer does not enter Sleep or Hibernation mode if the connection is actively in use.
- Make sure that the Sleep or Hibernation time-out is enabled.

The computer does not enter Sleep or Hibernation mode immediately.

- If the computer is performing an operation, it normally waits for the operation to finish.

The computer does not resume from Sleep or Hibernation mode.

- The computer automatically enters Sleep or Hibernation mode when the battery pack is empty. Do any one of the following:
 - Connect the AC adapter to the computer.
 - Replace the empty battery pack with a fully charged one.

The computer does not enter Hibernation mode with the Fn+F12 hot keys.

- Make sure that the Hibernation function is specified for the sleep button.
- You might be using a PC card that prevents the computer from entering Hibernation mode. To enter the mode, stop the communication program and then remove the card or stop the card.

Software Problems

An application program does not work correctly.

- Make sure that the software is correctly installed.
- If an error message appears on the screen, consult the software program's documentation for further information.

- If you are sure the operation has stop, reset the computer. (See “Resetting the Computer” later in this chapter.)

Sound Problems

No sound is produced.

- Make sure that the volume control is not set too low.
- Make sure that the computer is not in Sleep mode.
- If using an external speaker, make sure that the speaker is properly connected.

Distorted sound is produced.

- Make sure that the volume control is not set too high or too low. In most cases, a high setting can cause the audio electronics to distort the sound.

The sound system does not record.

- Adjust the playback or recording sound levels.

The external microphone or audio device does not work.

- Make sure that the microphone is connected to the proper connector on the computer.
- Click the speaker symbol on the taskbar and check the Windows volume control.
- Check the volume control of your computer.

Startup Problems

When you turn on the computer, it does not respond and the Power Indicator does not light green.

- If you are using an external AC power, make sure that the AC adapter is correctly and securely connected. If so, make sure that the electrical outlet works properly.

- If you are using the battery power, make sure that the battery is not discharged.

When you turn on the computer, it stops after POST.

- Restart your computer.

WLAN Problems

I cannot use the WLAN feature.

- Make sure that the mini PCI-E WLAN card is correctly installed.
- Make sure that the WLAN feature is turned on.

Transmission quality is poor.

- Your computer may be in an out-of-range situation. Move your computer closer to the Access Point or another WLAN device it is associated with.
- Check if there is high interference around the environment and solve the problem as described next.

Radio interference exists.

- Move your computer away from the device causing the radio interference such as microwave oven and large metal objects.
- Plug your computer into an outlet on a different branch circuit from that used by the affecting device.
- Consult your dealer or an experienced radio technician for help.

I cannot connect to another WLAN device.

- Make sure that the WLAN feature is turned on.
- Make sure that the SSID setting is the same for every WLAN device in the network.
- Your computer is not recognizing changes. Restart the computer.
- Make sure that the IP address or subnet mask setting is correct.

I cannot communicate with the computer in the network when Infrastructure mode is configured.

- Make sure that the Access Point your computer is associated with is powered on and all the LEDs are working properly.
- If the operating radio channel is in poor quality, change the Access Point and all the wireless station(s) within the BSSID to another radio channel.
- Your computer may be in an out-of-range situation. Move your computer closer to the Access Point it is associated with.
- Make sure that your computer is configured with the same security option (encryption) to the Access Point.
- Use the Web Manager/Telnet of the Access Point to check whether it is connected to the network.
- Reconfigure and reset the Access Point.

I cannot access the network.

- Make sure that the network configuration is appropriate.
- Make sure that the user name or password is correct.
- You have moved out of range of the network.
- Turn off power management.

Other Problems

The date/time is incorrect.

- Correct the date and time via the operating system or BIOS Setup program.
- After you have performed everything as described above and still have the incorrect date and time every time you turn on the computer, the RTC (Real-Time Clock) battery is at the end of its life. Call an authorized dealer to replace the RTC battery.

Resetting the Computer

You may have to reset (reboot) your computer on some occasions when an error occurs and the program you are using hangs up.

If the computer operation seems to hang up, first wait. It is possible that the computer is processing data. Periodically check the hard disk drive in-use indicator, if it flashes irregularly, the program may be accessing data and preventing you from using the keyboard. If you are sure the operation has stopped and you cannot use the "restart" function of the operating system, reset the computer.

Reset the computer by any one of these methods:

- Press **Ctrl+Alt+Del** on your built-in keyboard.
- If the above action does not work, turn off the computer with the power button. Wait for at least five seconds and turn it on again.

CAUTION: Resetting will cause any unsaved data to be lost.

Appendix A

Specifications

NOTE: Specifications are subject to change without any prior notice.

Parts		Specifications
CPU		Intel® Arrandale Low Voltage, Intel® Core™ i7-640LM or i7-620LM Processor, 25W, 1066 MHz FSB (Front Side Bus), 2.13 GHz (Turbo up to 2.93GHz) 4M L3 Cache
Chipset		Intel® QM57, dual channel support
BIOS		8 MB EEPROM, ACPI, Fingerprint security, SmartCard security, TPM, computrace, Vpro
RAM (system)		Up to 8GB, 2 × 204-pin SO-DIMM sockets for 1GB/2GB/4GB DDRII, 1066/1333 MHz, 1.25-inch height
Display	Panel	13.3-inch (4:3) wide TFT LCD, resolution up to 1024×768 XGA, with light sensor as default feature Can come with one of the below options: <ul style="list-style-type: none">– Sunlight-readable (1200 nits) touchscreen– Sunlight-readable screen with protection glass– Protection glass
	Video controller	UMA
	VRAM	Up to 1024MB
	Video port	Analog VGA
Audio	Features	Azalia interface, 2 channel analog output, internal microphone
	Speaker	1.5 watt (8 ohm) stereo × 2
	Ports	Two audio ports for Line-out (green color) / Mic-in (pink color)
Keyboard		Standard keys with numeric pad keys, 12 function keys, special Fn (Function) key and Windows keys with water-proof membrane or backlight (option)
Pointing device		Glide touchpad with 2 buttons, scroll bar

Parts		Specifications
Storage device	Hard disk drive	SATA interface, 2.5-inch diameter (9.5 mm height), 5400 rpm support, G-sensor, shock-mounted, user-removable, solid-state disk (option), automotive hard disk drive (option), low temperature – 4 °F (– 20 °C) up to 131 °F (55 °C) (option)
	DVD drive	SATA interface, Super-Multi DVD drive, 12.7mm height,
Card slots		Card Reader 2-in-1 (MMC/SD) module PCMCIA CardBus Type II x 2 or 1 with any of the following: ExpressCard/34 / ExpressCard/54 support, or Smart Card
I/O ports		USB port x 2 (USB 2.0 support), serial port x 2 (RS-232), eSATA/USB port, HDMI port, RJ-45 port, RJ-11 port, mini IEEE 1394a port, expansion bus connector
Modem		Azalia interface, 56 Kbps, V.90 MDC 1.5 internal fax modem
LAN		10/100/1000 Mbps
Wireless LAN		One mini PCI-E slot for wireless LAN card, compliant with IEEE 802.11a/b/g/n, on/off slide switch
Bluetooth wireless technology		Specification 2.0 module, 2.1 class 2 +EDR, on/off slide switch
GPS (option)		GPS module
3G (option)		CDMA EVDO, external accessible SIM card slot
Security		Kensington lock TPM 1.2 Fingerprint sensor Smart Card Reader (integrated) will occupy Type II PCMCIA slot – option
Power	AC adapter	Universal AC adapter 90 W; input: 100~240 V, output: 19 V
	Primary battery	Li-ion smart battery 9-cell 7650/7800 mAh / 11.1 V or above
	Secondary battery	Li-ion smart battery 9-cell 7650/7800 mAh / 11.1 V or above
Dimension (WxD)		303.5x298x60 mm (11.9x11.7x2.36 inch) with handle
Weight		3.8 kg (8.15 lb)

Appendix B

Regulatory Information

This appendix provides regulatory statements and safety notices on your computer.

NOTE: Marking labels located on the exterior of your computer indicate the regulations that your model complies with. Please check the marking labels and refer to the corresponding statements in this appendix. Some notices apply to specific models only.

On the Use of the System

Class B Regulations

USA

Federal Communications Commission Radio Frequency Interference Statement

NOTE:

This equipment has been tested and found to comply with the limits for a Class B digital device pursuant to Part 15 of the FCC Rules. These limits are designed to provide reasonable protection against harmful interference in a residential installation. This equipment generates, uses, and can radiate radio frequency energy and, if not installed and used in accordance with the instructions, may cause harmful interference to radio communications. However, there is no guarantee that interference will not occur in a particular installation. If this equipment does cause harmful interference to radio or television reception, which can be determined by turning the equipment off and on, the user is encouraged to try to correct the interference by one or more of the following measures:

- Reorient or relocate the receiving antenna.
- Increase the separation between the equipment and receiver.
- Connect the equipment into an outlet on a circuit different from that to which the receiver is connected.
- Consult the dealer or an experienced radio/TV technician for help.

Any changes or modifications not expressly approved by the manufacturer could void the user's authority to operate the equipment.

Please note:

The use of a non-shielded interface cable with this equipment is prohibited.

Canada

Canadian Department of Communications Radio Interference Regulations Class B Compliance Notice

This Class B digital apparatus meets all requirements of the Canada Interference-Causing equipment regulations.

Cet appareil numérique de Classe B respecte toutes les exigences du Règlement Canadien sur le matériel brouilleur.

This digital apparatus does not exceed the Class B limits for radio noise emissions from digital apparatus set out in the Radio Interference Regulations of the Canadian Department of Communications.

Le présent appareil numérique n'émet pas de bruits radioélectriques dépassant les limites applicables aux appareils numériques de la classe B prescrites dans le Règlement sur le brouillage radioélectrique édicté par le ministère des Communications du Canada.

Safety Notices

About the Battery

Caution Texts Concerning Lithium Batteries

DANISH

ADVARSEL! Lithiumbatteri – Eksplosionsfare ved fejlagtig håndtering. Udskiftning må kun ske med batteri af samme fabrikat og type. Levér det brugte batteri tilbage til leverandøren.

NORWEGIAN

ADVARSEL: Eksplosjonsfare ved feilaktig skifte av batteri. Benytt samme batteritype eller en tilsvarende type anbefalt av apparatfabrikanten. Brukte batterier kasseres i henhold til fabrikantens instruksjoner.

SWEDISH

WARNING: Explosionsfara vid felaktigt batteribyte. Använd samma batterityp eller en ekvivalent typ som rekommenderas av apparattillverkaren. Kassera använt batteri enligt fabrikantens instruktion.

FINNISH

VAROITUS: Paristo voi räjähtää, jos se on virheellisesti asennettu. Vaihda paristo ainoastaan valmistajan suosittelemaan tyyppiin. Hävitä käytetty paristo valmistajan ohjeiden mukaisesti.

ENGLISH

CAUTION: Danger of explosion if battery is incorrectly replaced. Replace only with the same or equivalent type recommended by the equipment manufacturer. Discard used batteries according to manufacturer's instructions.

DEUTSCH

VORSICHT: Explosionsgefahr bei unsachgemäßem Austausch der Batterie. Ersatz nur durch denselben oder einen vom Hersteller empfohlenen gleich-wertigen Typ. Entsorgung gebrauchter Batterien nach Angaben des Herstellers.

FRENCH

ATTENTION: Il y a danger d'explosion s'il y a un remplacement incorrect de la batterie. Remplacer uniquement avec une batterie du même type ou d'un type équivalent recommandé par le constructeur. Mettre au rebut les batteries usagées conformément aux instructions du fabricant.

Attention (for USA Users)

The product that you have purchased contains a rechargeable battery. The battery is recyclable. At the end of its useful life, under various state and local laws, it may be illegal to dispose of this battery into the municipal waste stream. Check with your local solid waste officials for details in your area for recycling options or proper disposal.

About the AC Adapter

- Use only the AC adapter supplied with your computer. Use of another type of AC adapter will result in malfunction and/or danger.
- Do not use the adapter in a high moisture environment. Never touch the adapter when your hands or feet are wet.
- Allow adequate ventilation around the adapter when using it to operate the device or charge the battery. Do not cover the AC adapter with

paper or other objects that will reduce cooling. Do not use the AC adapter while it is inside a carrying case.

- Connect the adapter to a proper power source. The voltage requirements are found on the product case and/or packaging.
- Do not use the adapter if the cord becomes damaged.
- Do not attempt to service the unit. There are no serviceable parts inside. Replace the unit if it is damaged or exposed to excess moisture.

About the Modem

Caution

- Never install telephone wiring during a lightning storm.
- Never install telephone jacks in wet locations unless the jack is specifically designed for wet locations.
- Never touch non-insulated telephone wires or terminals unless the telephone line has been disconnected at the network interface.
- Use caution when installing or modifying telephone lines.
- Avoid using the telephone function (other than a cordless type) during an electrical storm. There may be a remote risk of electric shock from lightning.
- Do not use the telephone function to report a gas leak in the vicinity of the leak.
- Do not use this product near water, for example near a bathtub, wash bowl, kitchen sink or laundry tub, in a wet basement or near a swimming pool.

Caution (for USA Users)

To reduce the risk of fire, use only No.26 AWG or larger telecommunication line cord.

On the Use of the RF Device

NOTE: The information in this section applies to models with the wireless LAN module.

USA and Canada Safety Requirements and Notices

IMPORTANT NOTE: To comply with FCC RF exposure compliance requirements, the antenna used for this transmitter must be installed to provide a separation distance of at least 20 cm from all persons and must not be co-located or operating in conjunction with any other antenna or transmitter.

Radio Frequency Interference Requirements and SAR

The FCC with its action in ET Docket 93-62 has adopted a safety standard for human exposure to Radio Frequency (RF) electromagnetic energy emitted by FCC certified equipment. The wireless LAN module meets the Human Exposure limits found in OET Bulletin 65, 2001, and ANSI/IEEE C95.1, 1992. Proper operation of this radio according to the instructions found in this manual will result in exposure substantially below the FCC's recommended limits. The following safety precautions should be observed:

- Do not touch or move antenna while the unit is transmitting or receiving.
- Do not hold any component containing the radio such that the antenna is very close or touching any exposed parts of the body, especially the face or eyes, while transmitting.
- Do not operate the radio or attempt to transmit data unless the antenna is connected; if not, the radio may be damaged.

Use in specific environments:

- The use of wireless devices in hazardous locations is limited by the constraints posed by the safety directors of such environments.

- The use of wireless devices on airplanes is governed by the Federal Aviation Administration (FAA).
- The use of wireless devices in hospitals is restricted to the limits set forth by each hospital.

Antenna use:

- In order to comply with FCC RF exposure limits, low gain integrated antennas should be located at a minimum distance of 20 cm (8 inches) or more from the body of all persons.
- High-gain, wall-mount, or mast-mount antennas are designed to be professionally installed and should be located at a minimum distance of 30 cm (12 inches) or more from the body of all persons. Please contact your professional installer, VAR, or antenna manufacturer for proper installation requirements.

Explosive Device Proximity Warning

WARNING: Do not operate a portable transmitter (such as a wireless network device) near unshielded blasting caps or in an explosive environment unless the device has been modified to be qualified for such use.

Antenna Warning

WARNING: To comply with the FCC and ANSI C95.1 RF exposure limits, it is recommended that the antenna for this device be installed so as to provide a separation distance of at least 20 cm (8 inches) from all persons and that the antenna must not be co-located or operating in conjunction with any other antenna or radio transmitter. It is recommended that the user limit exposure time if the antenna is positioned closer than 20 cm (8 inches).

Use on Aircraft Caution

CAUTION: Regulations of the FCC and FAA prohibit airborne operation of radio-frequency wireless devices because their signals could interfere with critical aircraft instruments.

EMC Requirements

This device uses, generates and radiates radio frequency energy. The radio frequency energy produced by this device is well below the maximum exposure allowed by the Federal Communications Commission (FCC).

This device complies with the limits for a Class B digital device pursuant to Part 15 subpart C of the FCC Rules and Regulations. Operation is subject to the following two conditions:

- (1) This device may not cause harmful interference.
- (2) This device must accept any interference received, including interference that may cause undesired operation.

The FCC limits are designed to provide reasonable protection against harmful interference when the equipment is installed and used in accordance with the instruction manual and operated in a commercial environment. However, there is no guarantee that interference will not occur in a particular commercial installation, or if operated in a residential area.

If harmful interference with radio or television reception occurs when the device is turned on, the user must correct the situation at the user's own expense. The user is encouraged to try one or more of the following corrective measures:

- Reorient or relocate the receiving antenna.
- Increase the separation between the equipment and receiver.
- Connect the equipment into an outlet on a circuit different from that to which the receiver is connected.
- Consult the dealer or an experienced radio/TV technician for help.

CAUTION: The Part 15 radio device operates on a non-interference basis with other devices operating at this frequency. Any changes or modification to said product not expressly approved by the manufacturer could void the user's authority to operate this device.

Canada Radio Frequency Interference Requirements

To prevent radio interference to the licensed service, this device is intended to be operated indoors and away from windows to provide maximum shielding. Equipment (or its transmit antenna) that is installed outdoors is subject to licensing.

Pour empêcher que cet appareil cause du brouillage au service faisant l'objet d'une licence, il doit être utilisé à l'intérieur et devrait être placé loin des fenêtres afin de fournir un écran de blindage maximal. Si le matériel (ou son antenne d'émission) est installé à l'extérieur, il doit faire l'objet d'une licence.

European Union CE Marking and Compliance Notices

Statements of Compliance

English

This product follows the provisions of the European Directive 1999/5/EC.

Danish

Dette produkt er i overensstemmelse med det europæiske direktiv 1999/5/EC.

Dutch

Dit product is in navolging van de bepalingen van Europees Directief 1999/5/EC.

Finnish

Tämä tuote noudattaa EU-direktiivin 1999/5/EC määräyksiä.

French

Ce produit est conforme aux exigences de la Directive Européenne 1999/5/EC.

German

Dieses Produkt entspricht den Bestimmungen der Europäischen Richtlinie 1999/5/EC.

Greek

Το προϊόν αυτό πληροί τις προβλέψεις της Ευρωπαϊκής Οδηγίας 1999/5/EC.

Icelandic

Pessi vara stenst reglugerð Evrópska Efnahags Bandalagsins númer 1999/5/EC.

Italian

Questo prodotto è conforme alla Direttiva Europea 1999/5/EC.

Norwegian

Dette produktet er i henhold til bestemmelsene i det europeiske direktivet 1999/5/EC.

Portuguese

Este produto cumpre com as normas da Diretiva Europeia 1999/5/EC.

Spanish

Este producto cumple con las normas del Directivo Europeo 1999/5/EC.

Swedish

Denna produkt har tillverkats i enlighet med EG-direktiv 1999/5/EC.

Local Restrictions of 802.11a/g/n Radio Usage

CAUTION: Due to the fact that the frequencies used by 802.11a/g/n wireless LAN devices may not yet be harmonized in all countries, 802.11a/g/n products are designed for use only in specific countries or regions, and is not allowed to be operated in countries or regions other than those of designated use. As a user of these products, you are responsible for ensuring that the products are used only in the countries or regions for which they were intended and for verifying that they are configured with the correct selection of frequency and channel for the country or region of use. Any deviation from permissible settings and restrictions in the country or region of use could be an infringement of local law and may be punished as such.

The European variant is intended for use throughout the European Economic Area. However, authorization for use is further restricted in particular countries or regions within countries, as follows:

General

European standards dictate maximum radiated transmit power of 100 mW Effective Isotropic Radiated Power (EIRP) and the frequency range 2400 – 2483.5 MHz.

Belgium and the Netherlands

In Belgium and the Netherlands, the product may not be used outdoors. See the instructions next under the heading “Turning Off the Wireless LAN Radio.”

France

Departments in Which the Wireless LAN Module Can Be Used (Indoors Only)

The wireless LAN module can currently be used indoors only in the following 38 departments of mainland France. Please turn off your wireless LAN radio when operating the device in areas/places other than the 38 departments listed:

01	Ain Orientales	36	Indre	66	Pyrénées
02	Aisne	37	Indre et Loire	67	Bas Rhin
03	Allier	41	Loir et Cher	68	Haut Rhin
05	Hautes Alpes	42	Loire	70	Haute Saône
08	Ardennes	45	Loiret	71	Saône et Loire
09	Ariège	50	Manche	75	Paris
11	Aude	55	Meuse	82	Tarn et Garonne
12	Aveyron	58	Nièvre	84	Vaucluse
16	Charente	59	Nord	88	Vosges
24	Dordogne	60	Oise	89	Yonne
25	Doubs	61	Orne	90	Territoire de Belfort
26	Drôme	63	Puy du Dôme	94	Val de Marne
32	Gers	64	Pyrénées Atlantique		

Departments in Which the Wireless LAN Module's Maximum EIRP Not Shown in the Previous Table

Frequency Ranges (MHz)	Indoors	Outdoors
2400 – 2446.5	10 mW	Not permitted
2446.5 – 2483.5	100 mW	100 mW on private property with Ministry of Defense approval

Turning Off the Wireless LAN Radio

NOTE: Turning the wireless LAN radio off is not the same as disabling the wireless LAN card. It is not necessary to disable the card to meet the regulatory requirements.

While operating the computer in those French departments that do not allow use of the wireless LAN equipment, the user of the equipment must turn off the wireless LAN radio in order to comply with local regulations.