

VIDEOBADGE VB-300 TECHNICAL SPECIFICATIONS

The VB-300 series of Body Worn Cameras represent the first generation of WiFi enabled VideoBadges by Edesix.

With a 130 degree horizontal field of view, day & night recording capability, RFID touch-assign enabled and integrated pre-record function, VB-300 VideoBadges are able to record unrivalled footage of ongoing incidents.







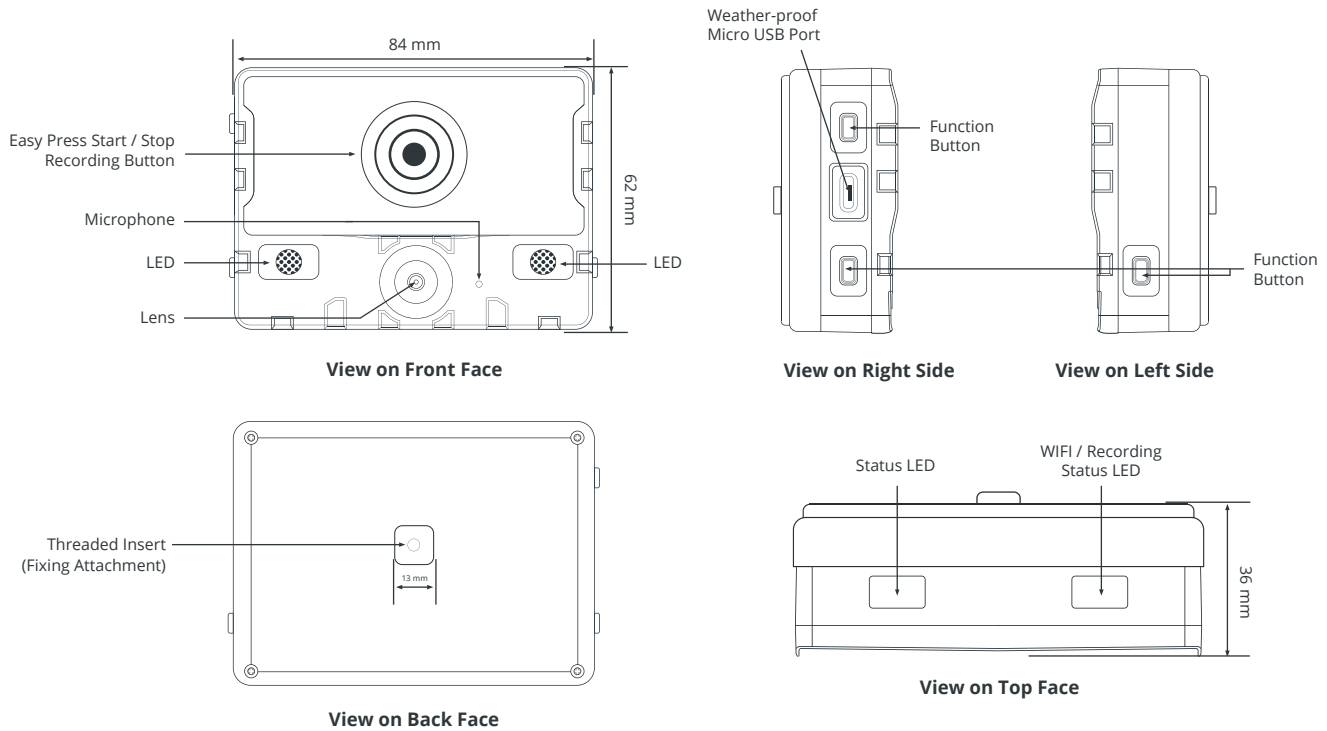







CAMERA FEATURE	DESCRIPTION / SPECIFICATION
Typical Usage	Deployments where the VB-300's large field of view, longer life battery and WiFi streaming capabilities are key.
Management Software	VideoManager 6.0 or later. Requires VideoManager Licence or Cloud Service.
Pre-record Facility	Continuous pre-record available, with configurable pre-record period. Note: <i>Pre-record function impacts battery-life.</i>
Dimensions	84mm x 62mm x 30mm (VB-320) x 36mm (VB-340).
Weight	100g without any mounting (VB-320), 140g without any mounting (VB-340).
User Access or Sealed Unit	Sealed unit with no user access to storage media or battery.
Storage Media	Internal solid state, protected recordings.
Recording Storage Capacity	16GB / 32GB (VB-320), 32GB (VB-340).
File size for hour of recording	1GB at 640 x 480 standard resolution, 2GB at 1280 x 720 HD resolution.
Battery capacity in standby (instant recording mode)	48hrs (VB-320) 96hrs (VB-340).
Battery type	Lithium-ion (no battery memory) does not require discharge before charging.
Battery overcharge protection	VideoBadge has overcharge protection so cannot be overcharged and can be left in docking station.

ED-002-003-11



CAMERA FEATURE	DESCRIPTION / SPECIFICATION
Battery indication	Power LED indicates: Green = battery charged Red = 15 minutes recording time left Blue = WiFi Active
Battery life in recording mode	Up to 7 hrs (VB-320) / 14 hrs (VB-340) when used with optimum camera settings.
Battery refresh process	3 years recommended refresh time, depending on amount of standby time required.
RFID assigned	Continual red blinking LED indicates badge is RFID assigned to you.
Bookmark footage	Pressing the top left button whilst recording is in process, will bookmark an instance within the video.
Configurable	Configure buttons, LEDs and recording functions to suit your needs.
Switches	Squeeze pair of buttons to start / stop recording or press the front of the camera to start / stop recording.
Recording status user notification	Visual recording light and audible beep to notify user of recording on / off.
Front display message	Options: <ul style="list-style-type: none"> 📄 Display card with message / logo

CAMERA FEATURE	DESCRIPTION / SPECIFICATION
Download rate	5mins per hour of recording (parallel downloading with docking station).
Frame rates	30/25/15/12.5 fps. By default VideoBadge records at 25 frames per second.
Resolution	<ul style="list-style-type: none">  Up to 1280 x 720 (HD)  640 x 480 standard setting - evidential quality  HD increases file size  MP4 Video Encoding
Recording rate	25/30 frames per second, real time recording. Note: <i>Each frame is available to view as a still image for evidential accuracy, by authorised user.</i>
Lens capture angle	Wide angle, 130 degree horizontal field of view.
Video downloading protected by encryption	AES 256, encrypted keys specific to base station.
Recordings view, copy and deletion ability	The VideoBadge wearer cannot access, view or delete any recordings. Only authorised users have access to recordings, after download at secure site.
Day / night operation	Supports low light conditions to 1 lux, meaning street lighting and internal lighting is adequate for operation.
Audio capture	Standard audio configuration is near field capture with background noise reduction.
Network data security on USB storage media	VideoBadge does not appear as a USB storage device and cannot receive files whilst connected to a network.
Surveillance and data protection compliance	<p>All compliance controls built in as standard.</p> <p>RIPA compliance (The Regulation of Investigatory Powers Act 2000) VideoBadge does not require RIPA authority to use, as is overt recording.</p> <p>Surveillance compliance VideoBadge front display, access restrictions and system controls for data management, provide compliance to Home Office - Surveillance Code of Practice.</p> <p>Data protection VideoBadge encryption-protected recordings, access restrictions, system controls and audit trail for Information Commissioner Office compliance.</p>
Anti-interference shielding	Built in radio anti-interference shield tested against Police TETRA and general two-way radio comms (SPEC5).
Battery recharging times	Within 4hrs / Within 8hrs (VB-320 / VB-340) from a fully flat battery.

CAMERA FEATURE	DESCRIPTION / SPECIFICATION
Download times	5 minutes per hour of recording.
Connections	USB to local computer. VideoBadge connection choice: <ul style="list-style-type: none">  Single cable USB charge  Wire free connection with 14-way docking station, mains and single USB connection
Weather proofing	Tested to IP65 weatherproof rating.
Warranty	1 year from purchase, extendable to 3 years. Special police specific warranty available.
Environmental temperature operational rating	-20°C to +40°C, non-condensing, operating.
Training	<ul style="list-style-type: none">  Training free system for VideoBadge operators  Full instruction manuals and telephone support for system managers  Optional on-site set-up and training when IT also supplied by Edesix
Running audit track log	Usage, operations and recording details all logged and indexed.
Digital evidence integrity chain	Full audit trail with generated check-sums and watermarked evidential outputs Note: <i>Routinely used in criminal and civil court actions.</i>
Frame count	Each frame is numbered and cannot be edited or amended without violating checksum.
Date & time watermark	Each frame has date and time watermark.
Time synchronisation	Time source is local PC, with options of network or web synchronisation.
Individual frame burning information	<ul style="list-style-type: none">  Device ID  Date and Time (UTC)  Universal time clock  Frame count number
WEEE compliant	Edesix observes all relevant Waste Electrical and Electronic (WEEE) regulations and honours the required arrangements for the safe disposal and recycling of its product.

CAMERA FEATURE	DESCRIPTION / SPECIFICATION
WEEE compliant	Edesix observes all relevant Waste Electrical and Electronic (WEEE) regulations and honours the required arrangements for the safe disposal and recycling of its product.

WIFI FEATURE	DESCRIPTION / SPECIFICATION
Specification	802.11 a/b/g/n (2.4GHz WiFi), infrastructure or ad-hoc.
Security	WPA2-Enterprise(*), WPA2-PSK, WPA-PSK, WEP or open.
Streaming	RTSP, 640x268p (SD) 700kbps, 64kps audio with digest or open authentication (VB-320 or VB-340).

MOUNTING OPTIONS	DESCRIPTION / SPECIFICATION
Uniform and clothing fixings	Fixed & Tilting Klick Fast, Crocodile style shirt-clip, sports-camera mounting.
Vehicle mounting option	Compatible with all Klick Fast and sports-camera dashboard and screen mounts.