

144/430/1200MHz TRIPLE BAND FM TRANSCEIVER

# DJ-G7

## Instruction Manual

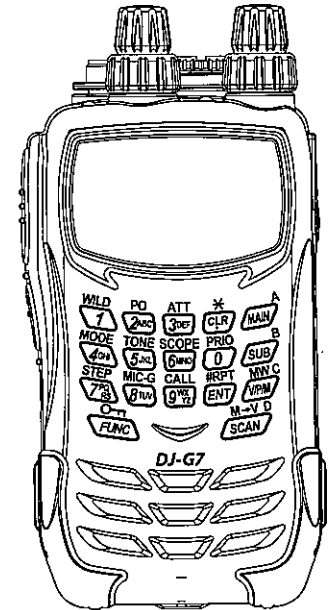

### ALINCO, INC.

Head Office: Yodoyabashi-Dai building 13th Floor  
4-9, 4-Chome, Koraihashi, Chuo-ku, Osaka 541-0043, JAPAN  
Phone: +81-6-7636-2362 Fax: +81-6-6208-3802  
<http://www.alinco.com>  
E-mail: [export@alinco.co.jp](mailto:export@alinco.co.jp)

Thank you for purchasing your new Alinco transceiver. Please read this manual carefully before using the product to ensure full performance, and keep this manual for future reference as it contains information on after-sales service. In case addendum or errata sheets are included with this product, please read those materials and keep them together with this instruction manual for future reference.

**NOTICE / Compliance Information Statement**

This equipment has been tested and found to comply with the limits for a Class B digital device, pursuant to part 15 of the FCC Rules. These limits are designed to provide reasonable protection against harmful interference in a residential installation.

This equipment generates, uses, and can radiate radio frequency energy and, if not installed and used in accordance with the instruction manual, may cause harmful interference to radio communications. However, there is no guarantee that interference will not occur in a particular installation. If this equipment does cause harmful interference to radio or television reception, which can be determined by turning the equipment off and on, the user is encouraged to try to correct the interference by one or more of the following measures:

- Reorient or relocate the receiving antenna.
- Increase the separation between the equipment and receiver.
- Connect the equipment into an outlet on a circuit different from that to which the transceiver is connected.
- Consult the dealer or an experienced radio/TV technician for help.

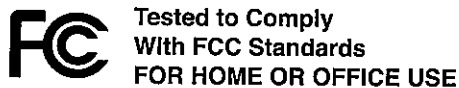

Information in this document is subject to change without notice or obligation. All brand names and trademarks are the property of their respective owners. Alinco cannot be liable for pictorial or typographical inaccuracies. Some parts, options and/or accessories are unavailable in certain areas. Changes or modifications not expressly approved by the party responsible for compliance could void the user's authority to operate the equipment.

144/430/1200MHz FM amateur radio handheld transceiver DJ-G7T

This device complies with Part 15 of the FCC Rules. Operation is subject to the following two conditions: (1) This device may not cause harmful interference, and (2) this device must accept any interference received, including interference that may cause undesired operation.

**Manufacturer:**

ALINCO, Inc. Electronics Division  
Yodoyabashi Dai Bldg 13F, 4-4-9, Koraibashi, Chuo-ku, Osaka 541-0043 JAPAN

**Conformity Information**

Alinco, Inc. Electronics Division hereby declares on our sole responsibility that the product(s) listed below comply with the essential requirements of the Directive 1999/5/EC, The council of 3/9/99 on Radio Equipment and Telecommunication Terminal Equipment and the mutual recognition of their conformity and with the provisions of Annex, after having performed the required measurements at Notified Bodies per Standards, and relative certificate(s) or document(s) can be reviewed at <http://www.alinco.com/Ce/>

DJ-G7E FM amateur radio handheld transceiver  
144.000~145.995MHz / 430.000~439.995MHz / 1260~1299.995MHz



This device is authorized for use in all EU and EFTA member states. An operator's license is required for this device. Copyright ©All rights reserved. No part of this document may be reproduced, copied, translated or transcribed in any form or by any means without the prior written permission of Alinco, Inc., Osaka, Japan, English Edition Printed in Japan.



Check with your local waste officials for details on recycling or proper disposal in your area.



## Accessories List

The following accessories are supplied with the DJ-G7. Please confirm that nothing is missing before using the product.

- DJ-G7 Transceiver
- Flexible Whip Antenna EA-163
- Li-ion Battery Pack EBP-73
- Drop-in charger EDC-173
- AC Adapter for Charging EDC-170(T-version)
- AC Adapter for Charging EDC-151A(E-version)
- AC Adapter for Charging EDC-152A(EUK-version)
- Belt Clip EBC-23
- Hand Strap
- Instruction Manual (this booklet)

Accessories may vary depending on the model you have purchased. Contact your local dealer for information on specifications of standard accessories and warranty details.

## Contents

<b>1. Warning</b> .....	<b>10</b>
1-1 Warning .....	10
1-2 Before transmitting .....	17
1-3 Introduction.....	17
<b>2. Features</b> .....	<b>18</b>
<b>3. Installing Accessories</b> .....	<b>19</b>
3-1 Antenna .....	19
3-1-1 Attaching the Antenna.....	19
3-1-2 Removing the Antenna .....	19
3-2 Hand Strap .....	19
3-3 Belt Clip.....	20
3-3-1 Attaching the Belt Clip.....	20
3-3-2 Removing the Belt Clip .....	20
3-4 Battery Pack.....	20
3-4-1 Attaching the Battery Pack .....	20
3-4-2 Removing the Battery Pack .....	21
3-5 Charging Battery Packs with the DC Jack.....	22
3-6 Charging Battery Packs with a Desktop Charger .....	23
3-7 Prevent Short-Circuiting the Battery Pack.....	23
3-8 Dry Cell Pack.....	24
3-9 Battery Charge Level Icon.....	25
<b>4. Names and Operations of Transceiver Controls</b> .....	<b>26</b>
4-1 Transceiver Functions and Operations.....	26
4-1-1 Top and Front .....	26
4-1-2 Sides.....	27
4-1-3 Keypad .....	28
4-2 Display (LCD).....	29

<b>5. Basic Operations .....</b>	<b>30</b>
5-1 Turning On the Transceiver.....	30
5-2 Selecting Frequencies .....	30
5-3 Adjusting the Audio Output (Volume) .....	30
5-4 Adjusting the Squelch .....	31
5-4-1 Operation .....	31
5-5 Monitor Function .....	32
5-6 Mute Function .....	32
5-7 Choosing the Operation Band.....	32
5-7-1 Operating in Mono Band .....	33
5-7-2 Switching the Sub Band and Main Band Frequencies.....	33
<b>6. Operation Modes .....</b>	<b>34</b>
6-1 Operating the Transceiver in the VFO Mode.....	34
6-2 Setting Channel Step Intervals.....	35
6-3 Increasing or Decreasing the Frequency in 1MHz Steps.....	35
6-4 Directly Inputting Frequencies.....	35
6-5 Operating the Transceiver in the Preset Mode .....	36
6-6 Reception .....	36
6-7 Transmitting.....	37
6-8 Tone Call Function.....	38
6-9 Repeater Function .....	38
<b>7. Memory Mode.....</b>	<b>39</b>
7-1 The Types of Memories and How to Use Them .....	39
7-2 Registering Memory Channels.....	40
7-3 Recalling Memory Channels.....	42
7-4 Deleting Memory Channels.....	43
7-5 Moving Memory Channels.....	44
7-6 Registering Memories for the Transmitter Detecting Function.....	45
7-7 Registering the Call Channel .....	45
7-8 Quick Memory.....	46
7-8-1 Registering the Quick Memory .....	46
7-8-2 Recalling the Quick Memory .....	46
7-9 Memory Skip Function .....	46
7-10 Memory Name Function .....	47

<b>8. Functions Allotted to the Keypad.....</b>	<b>51</b>
8-1 Shortcut Function .....	51
8-2 Transmitter Output Setting.....	51
8-3 Attenuator Function .....	52
8-4 Modulation Mode Setting.....	52
8-5 Tone Squelch Function/DCS Function Settings.....	53
8-5-1 Tone Squelch Function .....	53
8-5-2 DCS Function .....	54
8-6 Channel Scope Function.....	56
8-6-1 VFO Channel Scope.....	57
8-6-2 Memory Channel Scope .....	58
8-7 Changing the Channel Steps.....	59
8-8 Microphone Gain Setting .....	59
8-9 Recalling the Call Channels .....	60
8-10 Priority Function .....	60
8-11 Shift Setting.....	61
8-12 Copying a Memory Channel to the VFO Mode.....	61
8-13 XBR (Cross Band Repeater) Mode (T-version only) .....	62
8-14 RIT/TXIT Operation .....	63
<b>9. Convenient Functions .....</b>	<b>64</b>
9-1 Keylock Function .....	64
9-1-1 How to Lock Keys .....	64
9-1-2 Operations that are possible when the Keylock Function is active .....	64
9-2 Scan Function .....	65
9-3 VFO-Scan.....	65
9-4 Preset-Scan.....	66
9-5 Memory-Scan .....	66
9-6 Program Scan .....	67
9-7 Tone Scan.....	67
9-8 DCS Scan.....	68
9-9 Sweep Scan .....	68
9-10 Transmitter Detecting Function.....	70

<b>10. Set Mode .....</b>	<b>71</b>
10-1 Screen Display .....	72
10-1-1 Language .....	72
10-1-2 Illumination .....	73
10-1-3 Dimmer .....	73
10-1-4 Screen contrast .....	73
10-1-5 Font Size .....	74
10-1-6 Font Bold .....	74
10-1-7 Welcome Message Display .....	74
10-2 Power & Batt. ....	75
10-2-1 Auto-Power-Off .....	75
10-2-2 BS (Battery Save) ratio .....	75
10-2-3 Battery Type .....	76
10-3 Sound .....	77
10-3-1 Beep Sound LV (Level) .....	77
10-3-2 Pager .....	78
10-3-3 End-Beep .....	78
10-4 Transmitter .....	79
10-4-1 VOX .....	79
10-4-2 TOT (Time Out Timer) .....	80
10-4-3 TOT Penalty .....	80
10-4-4 BCLO (Busy Channel Lock Out) .....	81
10-4-5 Tone-Burst .....	81
10-4-6 Full-Duplex Setting .....	81
10-5 Repeater .....	82
10-5-1 Auto Repeater Set .....	82
10-6 DTMF (Dual Tone Multi Frequency) .....	83
10-6-1 Auto-Dialer .....	83
10-6-2 DTMF WAIT Time .....	85
10-6-3 DTMF Burst Period for the First Number .....	85
10-6-4 DTMF Burst Time .....	86
10-6-5 DTMF Pause Time .....	86
10-7 Reception Settings .....	87
10-7-1 AM Antenna Settings .....	87
10-7-2 Clock Noise Shift Settings .....	88
10-7-3 Tone SQ Priority Settings .....	88
10-7-4 DCS Operation Settings .....	89
10-7-5 TSF Operation Settings .....	89
10-7-6 Receiver Range Function .....	90
10-7-7 Preset Mode Settings .....	90

10-8 Memory Settings .....	91
10-8-1 Bank-Link Setting Function .....	91
10-8-2 Over Write Function .....	92
10-9 Scanning Settings .....	92
10-9-1 Scan Mode Settings .....	93
10-9-2 Scan Skip Settings .....	94
10-9-3 Priority Interval Setting .....	94
10-9-4 Priority Duration Setting .....	94
10-9-5 Backlight Setting While Scanning .....	95
10-10 BUG Detector Setting (T-version only) .....	95
10-10-1 Activate Settings .....	96
10-10-2 Detect Mode Settings .....	98
10-10-3 Sensitivity Settings .....	98
10-11 Key Assignment .....	99
10-11-1 Key Lock Mode Settings .....	99
10-11-2 Moni Key Mode Setting .....	100
10-11-3 Moni Operation Settings .....	100
10-11-4 Setting the Bands Subject to MONI Key Operations .....	100
10-11-5 Mainband Dial Setting .....	101
10-11-6 Dial Function Setting .....	101
10-11-7 Short-cut (Wild) key Setting .....	102
10-11-8 Band Transition Setting .....	102
10-11-9 Set Mode Exit Setting .....	103

## **11. Channel Indication Mode .....**

104

## **12. Cloning / PC Connection Functions .....**

105

12-1 How to Connect .....	105
12-2 Operating the Transceiver Sending Data .....	105
12-3 Operating the Radio Receiving Data .....	106
12-4 Packet Communications .....	107
12-4-1 Packet Communication Connections .....	107

## **13. Reset Functions .....**

108

13-1 Partial Reset .....	108
13-2 All Reset .....	108

## **14. Maintenance and Reference .....**

109

14-1 Troubleshooting .....	109
14-2 Options .....	111
14-2-1 Microphone/Speaker Plug Conversion Cable (EDS-14) .....	112



## **15. Specifications .....**







113

# 1. Warning

## 1-1 Warning

To ensure safe operation of Alinco's products, please read the "Warning" section before using this product. To ensure safe operation and prevent any danger to life and/or property, you may find the symbols shown below in this manual. Please read and understand the meaning of these symbols before using this product.









Symbols	Explanation
 <b>Danger</b>	This symbol is intended to alert the user to an immediate danger that may cause loss of life and/or property if the user disregards the warning.
 <b>Alert</b>	This symbol is intended to alert the user to a possible hazard that may cause loss of life and/or property if the user disregards the warning.
 <b>Caution</b>	This symbol is intended to alert the user to a possible hazard that may cause injury or the loss of property if the warning is disregarded.

Symbol	Explanation
	The  symbols contain information on what the user should be aware of in terms of dangers, alerts and cautions.
	The  symbol informs the user of prohibited acts. Specific information of what is prohibited is drawn inside or near the symbol.
	The  symbol contains information on what the user is instructed to do. Specific information on the instruction is inside the symbol (in this case the symbol instructs the user to unplug the adapter from the wall outlet).

The manufacturer declines any responsibilities against economic loss due to loss of communication opportunities caused by external factors such as malfunctions, mistakes, failures and/or blackouts.







# Danger

## Environment and conditions of use





-  For your safety, do not drive while handling the radio. It is recommended that you check local traffic regulations regarding the use of radio equipment while driving.  
Some jurisdictions prohibit the operation of a transceiver while driving.
-  Do not use this product in close proximity to other electronic devices, especially medical equipment. It may cause malfunctions and/or errors in those devices.
-  In case a liquid leaks from the product, do not touch it. It may damage your skin. If the liquid does contact your skin, rinse with plenty of cold water.
-  Never operate this product in facilities where radio products are prohibited for use, such as aboard aircraft, in airports, within or near business wireless stations or their relay stations, and in hospitals (do not even switch the product on). It may disturb safe flying, proper operation of other stations, interfere with radio reception and may cause malfunctions and/or errors in medical devices.
-  Use of this product may be prohibited or illegal outside your country. Check the regulations in effect at your destination before you travel.
-  The manufacturer declines any responsibilities for loss of life and/or property due to failure of this product.
-  Do not use multiple radios in very close proximity to one another. It may cause malfunction, errors and/or failures of the product(s).
-  The manufacturer and local dealers decline any responsibilities for errors and/or failures of the product when used as part of any systems and/or electronic devices.
-  Do not connect the product to unspecified options and/or accessories manufactured by other manufacturers. They may cause this product to malfunction.

1

### ■Handling this product





-  Be sure to reduce the audio output level to the minimum setting before using an earphone or a headset. Excess audio may damage hearing.
-  This product was adjusted before being shipped. Do not disassemble or modify the product; it could result in fire, electric shock and/or malfunction.
-  Do not cover this product with a cloth, which could cause the product to overheat. Severe overheating could cause the case to deform and/or result in fire. Avoid exposure to direct sunlight and use the radio in a well-ventilated environment.
-  Do not splash, or allow water to penetrate the product. Exposure to water could result in fire, electric shock and/or malfunction.
-  Do not operate this product in a wet place such as a shower. It may result in fire, electric shock and/or malfunction.
-  Do not place the product in a container carrying conductive materials, such as water or metal in close proximity to the product. If water leaks and/or metal penetrates the product, it may result in fire, electric shock and/or malfunction.

### ■About chargers



-  Do not use any adapter other than one compliant with the specified voltage. It may result in fire, electric shock and/or malfunction.
-  Do not plug multiple devices, including the adapter into a single wall outlet. It may result in overheating and/or fire.
-  Do not handle, connect and/or disconnect the adapter with a wet hand. It may result in electric shock.
-  Securely plug the power supply connector into the wall outlet. If a metal object comes into contact with the metal portion of the wall connector, it may result in fire, electric shock and/or malfunction.
-  Do not use the product if there is dirt or other material on the metal portion of the adapter. It may result in fire, electric shock and/or malfunction.

1



### ■About the power supply

-  Do not use any power supply other than one compliant with the specified voltage. It may result in fire, electric shock and/or malfunction.
-  Do not plug multiple devices, including the power supply into a single wall outlet.
-  Do not handle, connect and/or disconnect the power supply plug with a wet hand. It may result in electric shock.
-  Never attempt to use the power supply with the fuse holder removed. It may result in fire, electric shock and/or malfunction.
-  When a charger is powered from an external DC power source (adapter, power supply, cigar-plug cable etc), make sure that the device conforms with IEC/EN 60950-1.

### ■Cigar-lighter cable

-  Use only cigar-lighter cables specified by the manufacturer. If unspecified cables are used, it may result in fire, electric shock and/or malfunction.
-  Do not handle the cigar-lighter cable with a wet hand. It may result in electric shock.







### ■In case of emergency

-  In case of the following situation(s), please turn off the product and remove the batteries. If you are using the charger, unplug the adapter from the wall outlet. If you use the product when it is not operating properly, it may result in fire, electric shock and/or malfunction. Do not try to troubleshoot the problem yourself. Please contact your local dealer for service and assistance.
  - When a strange sound, smoke and/or strange odor comes out of the product.
  - When the product is dropped or the case is broken or cracked.
  - When a liquid or foreign object penetrates the product.
  - When a power cord is damaged (including cases where the insulation is damaged and/or when the cord is broken).
-  For your safety, turn off the transceiver and remove all external connections and accessories from the wall outlet if a thunderstorm is likely.



**■Maintenance**

-  Do not open the unit or its accessories. It may result in injury, electric shock and/or malfunction. Please contact your local dealer for service and assistance.



 **Caution**
**■Environment and conditions of use**

-  Do not use the product in proximity to a TV or radio. It may cause interference and receive interference.
-  Do not install in humid, dusty or insufficiently ventilated places. It may result in fire, electric shock and/or malfunction.
-  Do not install in unstable or vibrating locations. It may result in injury or damage when/if the product falls to the ground.
-  Do not place the product in locations where temperatures rise abnormally, such as in direct sunlight and/or in proximity to the vent of a heater in a car. High temperatures may cause deformation and/or discoloration of the case and damage to internal components that could result in fire.
-  Do not place the product in places where it may be exposed to oily smoke and/or steam. It may result in fire, electric shock and/or malfunction.
-  Be cautious of dew formation. Please completely dry the product before use when it happens.



**■About the transceiver**

-  Be careful with the whip antenna so it does not come into contact with your eyes.
-  Do not connect devices other than those specified to the jacks and ports on the product. It may result in damage to the devices.
-  For your safety, turn off the unit and remove the batteries, and if you are using the charger, unplug the adapter from the wall outlet when not using the product for an extended period of time. It is recommended to charge the battery pack occasionally to avoid over-discharging the pack.





**■About chargers**

-  Do not pull the cord when unplugging the adapter from the wall outlet. It may result in fire, electric shock and/or malfunction. Be sure to hold the adapter when unplugging.
-  Do not use the adapter in proximity to heaters. It may result in fire, electric shock and/or malfunction.

**■Maintenance**

-  When maintaining the product, turn off the unit and remove the batteries, and if you are using the charger, unplug the adapter from the wall outlet for your safety.
-  Use a soft, clean and dry cloth to wipe off dirt and condensation from the surface of the product. Never use benzene, thinners, alcohol or detergent for cleaning.

**■When using an external power source**

-  When using the cigar-lighter outlet in a car, use the optional cigar-lighter cable (EDC-36).
-  Please turn off the unit when connecting and disconnecting the cables of external power sources.
-  Do not directly connect the unit to cars equipped with 24 volt systems. It may result in malfunction or damage.
-  When you are using a switching power supply as a source of external power, there may be cases when the product receives switching noise. Be sure to use a communication grade power supply per IEC/EN60950-1.

**■About waterproof protection / IPX7 compatibility**

The European IPX7 designation provides specifications for limited waterproofing of the radio. The specifications are immersion in one meter (approx 3ft) of still sweet water for up to 30 minutes to warranty the product mainly for use in rain or snow. This compatibility is factory guaranteed for a period of one year provided all the jack covers are securely in place, any accessories connected must be genuine Alinco waterproof accessories and the radio has not been disassembled by the customer. The factory



has tested and made the equipment compatible to IPX7 certification during engineering. However, please understand that this equipment is NOT certified IPX7 compliant but is designed to remain operational when used in rain, severe weather or in accidental cases of dropping it in water when used in extreme conditions and is in no way stating that you should attempt use the radio under water or submerge the radio for cleaning. Warranty will not cover radios that have water / salt damage due to negligence or misuse of the product.

### ■About 1200MHz frequency operations

- You may experience fading and other conditions such as hearing more noise on the 1200MHz band than on the 144MHz or 430MHz bands. This is because the 1200 MHz signal is prone to instability, especially in the case of mobile-operation; it is not due to a malfunction of the product.
- Because it uses a temperature compensated crystal oscillator (TCXO), the frequency stability of this product is very high. While communicating with transceivers that don't use a stable oscillator, it is possible the frequency may drift during a contact especially on 1200MHz. This is due to conditions at the other station and not due to a malfunction of DJ-G7.  
Use of RIT/TXIT is recommended in such event.
- Your RX/TX signals may be interfered by noise when you operate near by its source such as florescent lights especially on 1200MHz band but it is not a defect.  
Please operate away from the noise source or reduce the output power to eliminate or reduce it.

### ■Lightning

No person is safe outdoors during thunderstorms. It is more dangerous when using a handheld radio. The chances of being hit by lightning are greater since lightning may hit a radio antenna. At this time, there is no handheld radio having any kind of protection against lightning current (which is higher than 10kA). Note also that no car provides adequate protection of its passengers or drivers against lightning. Therefore, Alinco will not take responsibility for any danger associated with using its radio products outdoors or inside a car during a lightning storm.

### ■Limited Power Source

Please note that the transceiver enclosure only provides mechanical protection for its internal parts; it will not contain a fire within the device if the fire starts under certain fault conditions. Alinco will not take responsibility for any fire hazard associated with powering the transceiver or charging its batteries using a power source that does not belong to the limited power source in the meaning of EN60950-1.

### ■About operating frequencies and spurious signals

When received frequencies are as shown below, there may be cases when you receive non-modulated carriers. This is due to the frequency composition of the product and not due to a malfunction.

Main side frequency - 51.65MHz = Sub side frequency - (50.75 X 2) MHz  
 Main side frequency - (51.65 x 2) MHz = Sub side frequency + 50.75MHz  
 Main side frequency - (51.65 x 2) MHz = Sub side frequency - 50.75MHz  
 (VHF bandwidth - 51.65MHz) x integral multiple = VHF bandwidth frequencies  
 (VHF bandwidth - 51.65MHz) x integral multiple = UHF bandwidth frequencies  
 (UHF bandwidth - 51.65MHz) x integral multiple = UHF bandwidth frequencies

When the received frequency is approximately 3 times the transmitted frequency, it causes signal suppression.

When receiving simultaneously, if the sub band's VCO frequency is near the main band's IF frequency, the indicated frequency causes reception suppression.

## 1-2 Before transmitting

There are many business radio stations operating in proximity to the ham bands. Be careful not to cause interference when transmitting around such radio stations. Even when amateur radio stations adhere to radio laws, there are unexpected cases of radio interference. When operating this product while traveling, please be very careful.

## 1-3 Introduction

- Please read this manual completely to learn all the functions the product offers. We made every attempt to edit this manual to be as comprehensive and easy to understand as possible. It is important to note that some of the operations may be explained in relation to information in different chapters. By reading just one part of the manual, you may risk not understanding the complete explanation of the function.
- In case addendum sheets such as errata are included with the package, please read them and keep them together with this manual for your future reference.
- This product is manufactured and shipped under strict quality control procedures. However, if you find anything unusual about this product, contact your local dealer as soon as possible.
- Due to the large bandwidth capability of this product, there will be cases when you cannot receive radio signals and/or instances when you hear noise due to the inner spurious signals generated by the unit; these cases are not malfunctions.
- Information in this document is subject to change without notice or obligation.
- In case there are problems with this manual, such as missing pages, we will exchange this document for a new one at no charge.

## 2.Features

The DJ-G7 has the following features:

- 1.A full-duplex system that allows operating the main band and the sub band simultaneously.
- 2.The DJ-G7 is a triple band handheld transceiver that allows transmitting and receiving on 1200MHz frequencies as well as 144MHz and 430MHz.
- 3.Independent dials are provided respectively to the main band and the sub band. The operating frequencies, volume and squelch levels can be adjusted.
- 4.It features a large-screen full-matrix LCD with clear characters and easy-to-read icons that facilitates easy operation.
- 5.Allows reception of broadcast AM/SW/FM radio station programs (all versions) and other communications corresponding to a wide range of received frequencies from 0.5 to 1300MHz. (T/EG-versions)
- 6.A bar antenna at the bottom of the unit allows clearer reception of AM radio station programs.
- 7.The DJ-G7 includes a VOX function allowing "hands-free" contacts.
- 8.There are 2 modes of bug device detection. In cases where a "bug" device is being used, the unit alerts you with an icon and a beep (T-version only).
- 9.A clone function allows copying configurations and various data between DJ-G7 units. Configurations and data can also be edited when connected to a PC (optional cable required).
- 10.Includes CTCSS/DCS reverse tone squelch functions as standard .
- 11.Alinco's patented channel scope function allows visually monitoring signals received on the main channel and those nearby.
- 12.A "Wild Key" that allows jumping to a frequently used set-mode function.

## 3.Installing Accessories

### 3-1 Antenna

#### 3-1-1 Attaching the Antenna

- 1.Hold the antenna by its base and turn it clockwise (right).
- 2.When it stops, confirm the antenna is securely connected.

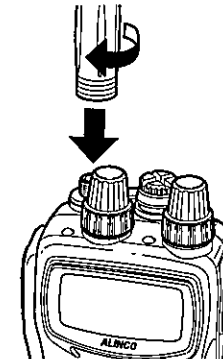

MEMO

•The SMA connector on the transceiver may also be used with external antennas.

#### 3-1-2 Removing the Antenna

- 1.To disconnect, turn the antenna counter clockwise.

### 3-2 Hand Strap

- 1.Attach the hand strap to the hole at the back of the product as shown in the illustration.

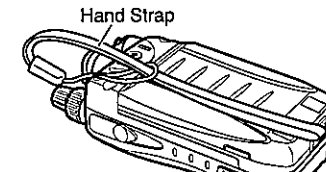

### 3-3 Belt Clip

#### 3-3-1 Attaching the Belt Clip

1. Fix the belt clip along the groove on the back of the product, and turn the screw clockwise (right).

2. Confirm that the belt clip is securely attached.

\*There are cases when the screw loosens. Check the screw occasionally.

\*The belt clip is adjusted for use with a maximum belt width of 8 centimeters.

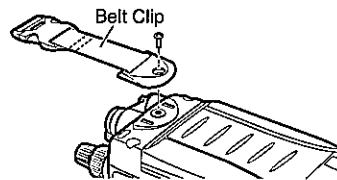

#### 3-3-2 Removing the Belt Clip

1. Turn the screw counter-clockwise (left) and remove the belt clip.

### 3-4 Battery Pack

To charge the Li-ion battery pack (EBP-73), please refer to "Charging Battery Packs with a Desktop Charger (P.23)" and "Charging Battery Packs with the DC Jack (P.22)".

#### 3-4-1 Attaching the Battery Pack

1. Align the catches on the transceiver with the grooves on the battery pack, and push the battery pack in the direction of the arrow (1).

2. Slide the latch in the direction of the arrow (2).

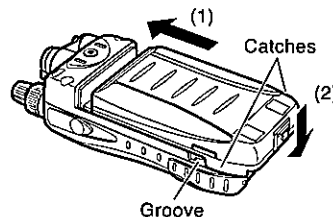

#### 3-4-2 Removing the Battery Pack

1. Slide the latch at the bottom of the battery pack in the direction of the arrow (1), and remove the battery pack (2).

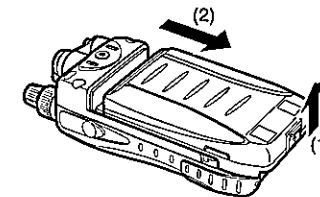

CAUTION

- The battery pack is not fully charged when shipped. It must be charged before use. Charging should be conducted within a temperature range of 0°C to +45°C (+32°F to +104°F).
- Do not modify, dismantle, incinerate or immerse the battery pack in water as such actions can be dangerous.
- Never short-circuit the battery pack terminals, as this can cause damage to the equipment or lead to overheating the battery which may cause burns.
- Unnecessary prolonged charging (overcharging) can deteriorate battery performance.
- The battery pack should be stored in a dry place where the temperature range is within -10°C to +45°C (-14°F to +113°F). Temperatures outside this range can cause the battery liquid to leak. Exposure to prolonged high humidity can cause corrosion of metal components.
- The battery pack is a consumable part. When its operating time becomes considerably short after a normal charge, it is likely the pack is exhausted and should be replaced with a new one.
- The battery pack is recyclable. When its useful life is over, it should be recycled by taking it to your local waste management or recycling facility.
- Wipe off dirt and condensation from the surface of the transceiver, battery pack and charger with a soft, dry cotton cloth periodically.
- If you're not using the battery pack for an extended period, charge it once every 3 months to prevent deterioration of the batteries.

### 3-5 Charging Battery Packs with the DC Jack

This product uses an adapter and a DC power supply (DC 12 V, more than 1A: EEC/EN60950 standard) that allows charging the Li-ion battery pack through the transceiver. When fully discharged, it can be charged in approximately 5 hours.

1.Refer to "Battery Pack (P.20)," and attach the battery pack.

2.Connect the plug of the adapter to the DC jack of the DJ-G7, then plug the adapter into a wall outlet.

\*The adapter shown in the illustration may vary depending on the included adapter.

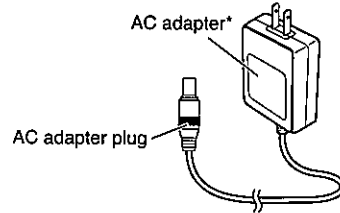

•Refer to "Battery Charge Level Icon (P.25)" for an indication the battery is charging.



•Do not transmit or receive when using the DC adapter. It may cause a malfunction. The provided adapter is for battery charging only.



•Please read the cautionary statement included with the optional accessories, and use the product properly and safely.  
•If the supply voltage is unstable, the charger will not operate properly.

### 3-6 Charging Battery Packs with a Desktop Charger

When using the Desktop Charger, the product can be fully charged in approximately 3 hours.

1.Connect the Desktop Charger to the adapter plug.

2.Plug the adapter into the wall outlet, and insert the transceiver into the Desktop Charger.

The red indicator on the Desktop Charger turns on while charging.

When charging is completed, the red indicator turns off.

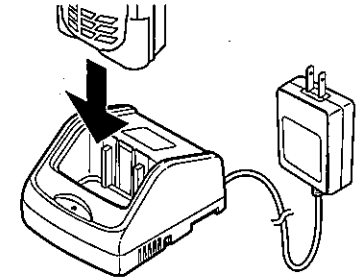

•In case the transceiver can't be charged with the battery pack attached, charge the battery pack separately to determine if there is a malfunction in the radio.

### 3-7 Prevent Short-Circuiting the Battery Pack

Be extra cautious when carrying the rechargeable battery pack: short-circuiting will produce a surge in current possibly resulting in a fire.

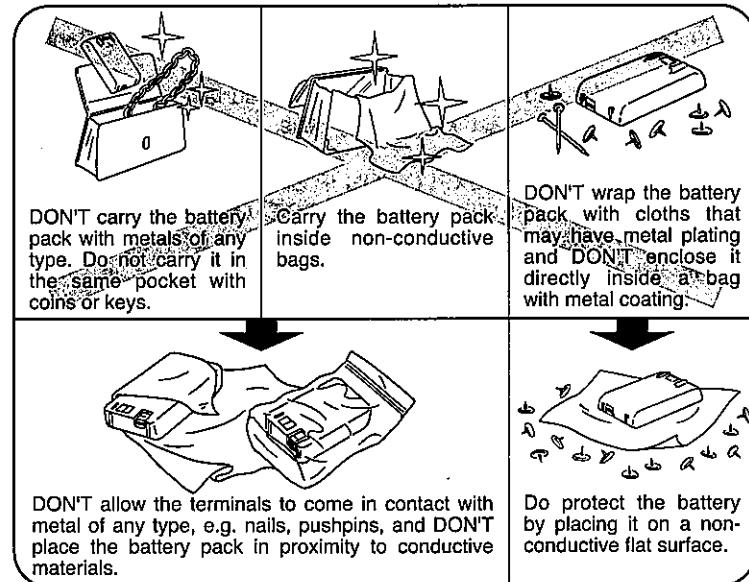

### 3-8 Dry Cell Pack (Optional)

1.Lift the catches up and remove the cover.

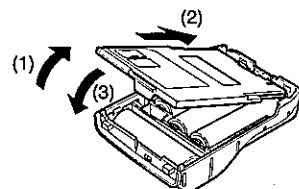

2.Place 4 size AA batteries in the case, and close the cover in the order of (2)→(3). Confirm that the cover is securely closed. Use alkaline dry cells. Manganese dry cells cannot be used.

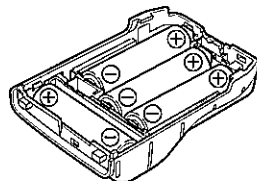

MEMO

- When using dry cells, refer to “Battery Type (P.76)”.
- Please be advised that EDH-35 dry cell case is an optional accessory for DJ-G7T and DJ-G7E.



CAUTION

- The dry cell case is not waterproof.
- Be careful to observe the correct polarity of +/- . Reversed polarity may cause electric leakage, fire and/or explosion.
- When installing dry cells, use the same type from the same manufacturer.
- When replacing dry cells, change all of them at the same time.
- The use of rechargeable batteries is not acceptable. The manufacturer declines any responsibilities against loss and/or injury to body and/or property damage when rechargeable batteries are used.
- Wipe off dirt and condensation from the surface of the electrodes that come into contact with the dry cells. Use a clean dry cloth or a cotton swab.
- THERE IS RISK OF EXPLOSION IF BATTERIES ARE REPLACED BY AN INCORRECT TYPE.DIPOSE OF USED BATTERIES ACCORDING TO THE INSTRUCTIONS OF YOUR LOCAL REGULATIONS.

### 3-9 Battery Charge Level Icon

The battery level icon shown on the display indicates the amount of charge remaining in the battery. When it changes to empty, charge the battery pack or replace the cells with new ones.

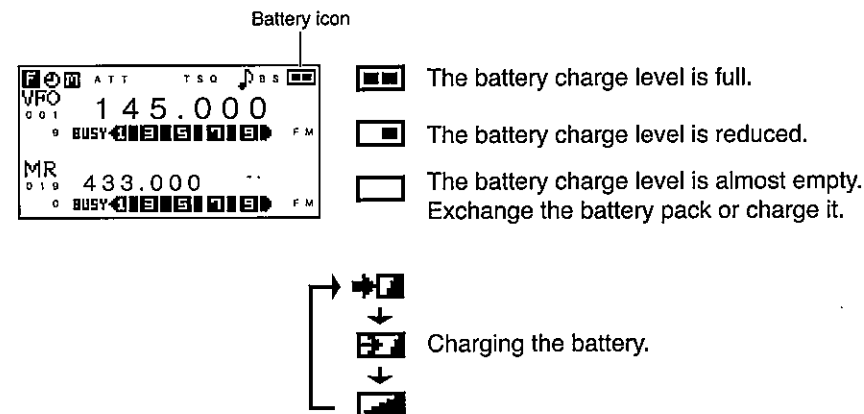

- When the transceiver is turned off, an icon indicates “charging” on the display. When charging is complete, the display indicates “charge completed”. When using the Desktop Charger, “charge completed” will not be shown on the display.

# 4.Names and Operations of Transceiver Controls

## 4-1 Transceiver Functions and Operations

### 4-1-1 Top and Front

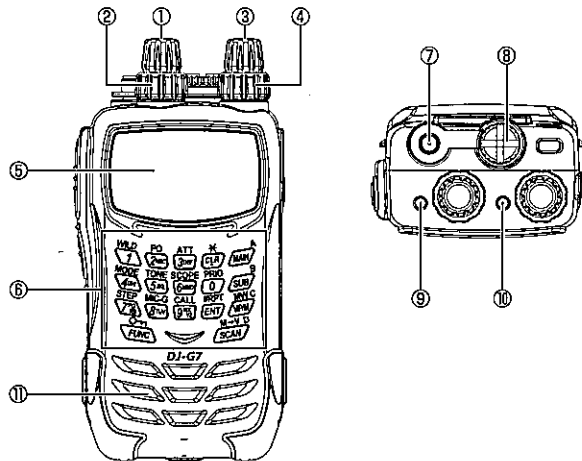

	Name	Function
①	Main Dial (upper)	Rotate the dial to select the main band frequency in VFO mode, or the memory channel when in Memory mode and to change various settings. When the <b>F</b> indicator is displayed, the transceiver enters the Set mode.
②	Main Dial (lower)	Rotate the dial to change the volume of the main band and to change various settings.
③	Sub Dial (upper)	Rotate the dial to select the frequency or memory channel of the sub band and to change various settings. When the dial is pressed while the <b>F</b> indicator is displayed, the Set mode is activated.
④	Sub Dial (lower)	Rotate the dial to change the volume of the sub band and to change various settings.
⑤	Display	Indicates the state of the transceiver. Refer to "Display Indicators" for details.
⑥	Keypad	Used for directly inputting frequencies and various settings.
⑦	Antenna Connector (SMA)	The antenna should be securely connected to the transceiver. If you plan to use an optional antenna, select one that is tuned to the proper operating frequency.

	Name	Function
⑧	Earphone/Microphone terminals	Connect the specified optional external earphone/microphone to the transceiver. When the terminals aren't used, securely cover them to keep out water and dust.
⑨	Main TX/RX LED	The LED is green when the main side squelch is not muted. The LED is red when transmitting.
⑩	Sub RX LED	The LED is green when the sub side squelch is not muted.
⑪	Microphone	When transmitting, speak approximately 5 centimeters from the microphone.

### 4-1-2 Sides

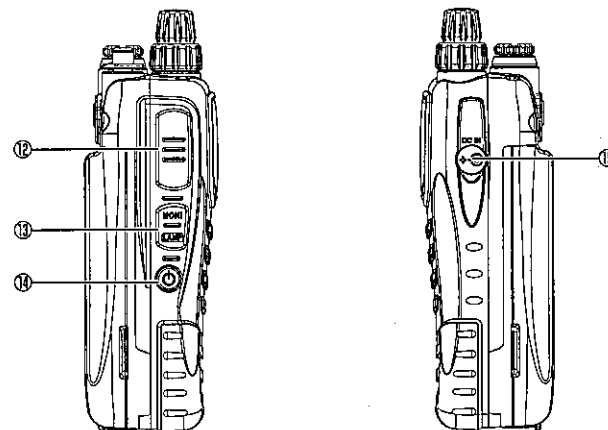

	Name	Function
⑫	PTT key	Press the PTT key to transmit, release to receive.
⑬	MONI key (LAMP) key	When the MONI key is pressed, the squelch mute function is switched off. When pressing the MONI key after pressing the <b>MONI</b> key, illumination settings can be set.
⑭	Power switch	Press and hold the power switch down for approximately one second to turn the unit on/off.
⑮	DC jack	This is the terminal for connecting an external DC power supply. It can be connected to adapters or used in mobile operation with an optional cigar-lighter cable. The transceiver can operate using a DC supply from 7.0 to 16 V and a minimum current rating of 3 A.

### 4-1-3 Keypad

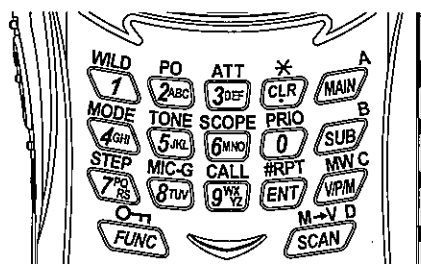

4

Key	Function	After pressing the FUNC key	Continuously pressing keys (for approximately one second)	Operating dials while pressing keys
1	Inputs 1	Wild key	Registering and releasing Quick Memory (when Memory Mode is turned on)	-
2	Inputs 2	Transmit power setting		
3	Inputs 3	Attenuator setting		
4	Inputs 4	Selecting modulation modes		
5	Inputs 5	Tone Squelch/DCS/modulated-carrier canceller setting		
6	Inputs 6	Channel Scope setting		
7	Inputs 7	Channel Step		
8	Inputs 8	Microphone Gain setting		
9	Inputs 9	Recalling Channel Step		
0	Inputs 0	Priority		
.	Inputs decimal point	Memory Clear (when memory mode is turned on)		
ENT	Determination of inputs Reverse	RIT/TXIT operation		
MAIN	Switches between bands/banks	Shift	Select Main Band Dual/Mono Band	Selecting bands/banks
SUB	Switches between bands/banks	Switching Main Band/Sub Band frequencies	Switching Sub Band Dual/Mono Band	
V/P/M	Switches operation modes	Memory Registration/Memory Editing/Memory Name function		
SCAN	Scan function	M→V function		Selecting Scan mode
FUNC	Function key	Turning off <b>F</b>	Key lock setting	Enables tuning 1MHz up/down

### 4-2 Display (LCD)

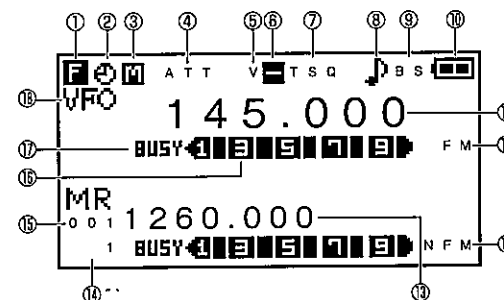

4

No.	Name	Function
①	<b>F / On / On</b>	Appears when the FUNC key is pressed and when the Key lock is activated.
②		Appears when the Auto Power Off function is activated.
③	<b>M / E</b>	Displays the operation band
④	<b>ATT</b>	Appears when the Attenuator function is activated.
⑤	<b>V / D</b>	Appears when the VOX function is operating and the Auto Dialer is transmitting.
⑥	<b>← / →</b>	Displays the shift direction for repeater operations.
⑦	<b>T / TSQ / DCS</b>	Appears when the Tone Squelch and DCS functions are activated.
⑧		Displays when the bell function is set.
⑨	<b>BS</b>	Displays when the Battery Save function is activated.
⑩		Displays the battery charge level.
⑪	<b>145.000</b>	Displays the main band frequency.
⑫	<b>FM</b>	Displays the mode (AM, FM, NFM and WFM).
⑬	<b>1260.000</b>	Displays the sub band frequency.
⑭	<b>1</b>	Displays the Memory Bank number.
⑮	<b>001</b>	Displays the Memory Channel number.
⑯		Displays received signal strength and transmitted power output.
⑰	<b>BUSY / MUTE</b>	Appears when the squelch is not muted.
⑱	<b>VFO</b>	Displays the operation mode.

## 5. Basic Operation

### 5-1 Turning On the Transceiver

1. The power turns on when the  key is pressed and held approximately one second.

Use the same operation to turn the power off.

\*The  key is designed hard enough to press on purposes so it doesn't turn off while in use.

5

### 5-2 Selecting Frequencies

#### ●To select a Main Band frequency

Rotate the upper main dial.

#### ●To select a frequency on the Sub Band

Rotate the upper sub dial.

Frequencies increase when rotated clockwise and decrease when rotated counterclockwise.

### 5-3 Adjusting the Audio Output (Volume)

There are 21 audio output levels (from 0 to 20)

The default setting is level 10.

#### ●Adjusting the Main Band Volume

Rotate the lower main dial.

#### ●Adjusting the Sub Band Volume

Rotate the lower sub dial.

The audio increases when the dial is rotated clockwise and decreases when rotated counterclockwise.

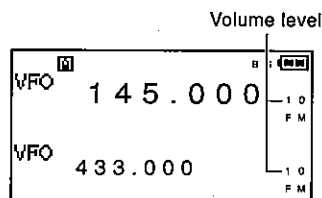

CAUTION

Be careful when using earphones. Confirm the volume is at a low level and then increase it gradually.



MEMO

#### When nothing can be heard

When the squelch is closed or the mute function is activated, received signals can't be heard even when the volume is increased. Please read "Adjusting the Squelch (P.31)" and "Mute Function (P.32)" for details.

### 5-4 Adjusting the Squelch

#### ●About the Squelch Function

Squelch is a function that allows audio from the speaker only when receiving a signal greater than a certain level. It eliminates unwanted noise heard from the speaker when there are no received signals to monitor. Increasing the squelch level allows the reception of strong signals but weak signals will not be received. When the squelch is active and audio is received, it is described as "opening the squelch" and the opposite is described as "closing the squelch". When the squelch opens depends on how strong the received signal is and is determined by the squelch setting.

The squelch level may need occasional adjustment as conditions warrant, such as the need to monitor a weak signal.

There are 10 squelch levels that can be adjusted in a range from 0 to 9.

#### 5-4-1 Operation

##### ●Adjusting the Main Band Squelch

Press the main dial once and rotate the upper main dial.

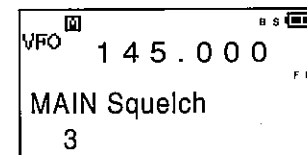

##### ●Adjusting the Sub Band Squelch

Press the sub dial once and rotate the upper sub dial.

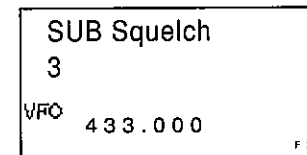

The squelch level increases when rotating the dial clockwise and decreases when rotating the dial counterclockwise.

When you want to open the squelch as a permanent setting, set the squelch level at 0.

When the squelch is open, the scan functions don't operate. When you want to operate the scan functions, adjust the squelch level until no noise can be heard.

5



## 5-5 Monitor Function

The monitor function is a function that enforces to open the squelch. When the received signal is weak or when the audio is broken, it temporarily opens the squelch regardless of the squelch level setting. This function is useful when the "Moni Key Mode Setting (P.100)" is set as the monitor function.

There are two types of monitor functions, PUSH and HOLD. By pressing the MONI key, **BUSY** appears on the display and the squelch opens in either case.

- In the PUSH setting, the squelch opens only while the MONI key is pressed.
- In the HOLD setting, the squelch stays open when pressing the MONI key. By pressing the MONI key again, the monitor function is released and the squelch function returns to normal.
- Please read "Moni Operation Settings (P.100)" in the setting mode for the steps needed to select the PUSH or HOLD setting and vice-versa.



MEMO

- When using the monitor function, the tone squelch and the DCS are also temporarily deactivated.

## 5-6 Mute Function

This function doesn't allow audio output even when a signal is received and the squelch is open. This function is usable when the "Moni Key Mode Setting (P.99)" is set to the mute function.

The mute function also has two settings, PUSH and HOLD. By pressing the MONI key, **MUTE** appears on the display and the mute function operates in either case.



MEMO

- Either the monitor function or the mute function can be chosen (not both).

## 5-7 Choosing the Operation Band

The operation band may be chosen from either the main band or the sub band.

- 1.Choose the operation band by pressing the **MAIN** key or the **SUB** key.

The frequency of the chosen band is indicated in large characters in dual band displays.

In mono band display, only one frequency is shown.

- 2.By pressing the **MAIN** key or the **SUB** key successively, the band changes.



MEMO

- While pressing the **MAIN** key or the **SUB** key and rotating the upper dial, the band moves rapidly.
- M** indicates that the main band is the operation band and the **S** indicates that the sub band is the operation band.

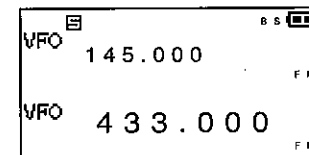
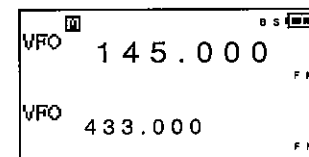

### 5-7-1 Operating in Mono Band

- To operate the main band as mono band.

- 1.Press and hold the **MAIN** key continuously for approximately one second.

The main band is displayed as the mono band. In order to return the main band to dual band, repeat the same step.

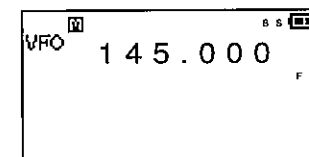

- To operate the sub band in mono band.

- 1.Press and hold the **SUB** key continuously for approximately one second.

The sub band is displayed as the mono band. In order to return the sub band to dual band, repeat the same step.

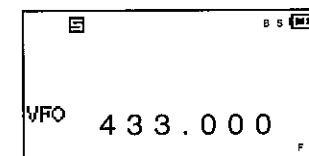

### 5-7-2 Switching the Sub Band and Main Band Frequencies

When setting both the main band and the sub band to the amateur transmitting and receiving bands, this transceiver allows exchanging frequencies of the sub band and main band.

- 1.Press the **Q-TX/FUNC** key.

- 2.Press the **SUB** key.

By following these steps, the frequencies of the sub band and the main band are exchanged.

# 6.Operation Mode

The DJ-G7 has 3 operation modes: the VFO, Preset and Memory mode.

VFO mode	VFO is the abbreviation of Variable Frequency Oscillator. This mode allows choosing the frequency by rotating the dial.
Preset mode	The audio frequencies of AM and FM radios and TV channels are preset in the sub band. Using the frequency limitation function, the preset mode of repeater frequency bands can be added to the main band (T-version only)(P.90).
Memory mode	The Memory mode recalls frequencies registered previously. Please read "Memory Mode (P.39)" to practice memory registration.



•Only analog TV audio may be received. TV audio from digital transmissions cannot be received.

•Switching the operation mode

Every time the key is pressed, the modes switch in the order shown in the illustration.

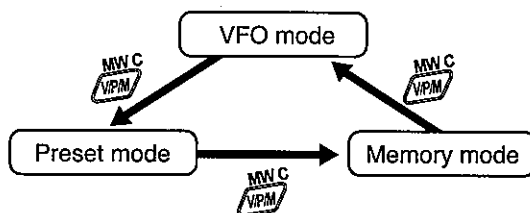

•The Preset mode can be deleted from the choices of operation modes.  
•The repeater operation frequency alone can be added to the main band as the Preset mode. Please read "Receiver Range Function (P.89)" and "Preset Mode Settings (P.90)" for details.

## 6-1 Operating the Transceiver in the VFO Mode

This is the mode that is active when the transceiver is turned on after being shipped from the factory. Frequencies can be selected by rotating the dials.

### •Switching Bands

A band can be chosen by pressing the key or the key.

## 6-2 Setting Channel Step Intervals

Channel steps can be defined as intervals or steps between amateur radio frequencies and/or radio and TV stations assigned by respective countries. Although this product is programmed with standard steps, it allows changing the steps if necessary. Please refer to "Changing the Channel Steps (P.59)" for adjusting channel steps.

## 6-3 Increasing or Decreasing the Frequency in 1MHz Steps

### •Changing Frequencies on the Main Band

In the VFO mode, to change frequencies on the main band in steps of 1 MHz, rotate the upper main dial while pressing the key. The displayed frequency will increase or decrease in 1MHz steps.

### •Changing Frequencies on the Sub Band

In the VFO mode, when changing frequencies on the sub band, rotate the upper sub dial while pressing the key. The displayed frequency will increase or decrease in 1MHz steps.



•When increasing or decreasing sub band frequencies in 1MHz steps, the frequency will change without regard to the range of specific bands.

•If the dial isn't rotated when the key is pressed, the Key lock activates. Press and hold to unlock.

## 6-4 Directly Inputting Frequencies

Frequencies can be directly entered using the numerical keypad.

Example 1: To enter 145.000MHz,  
press the , and keys and press the key.

Example 2: To enter 0.720MHz (sub band),  
Press the , and keys and press the key.  
Press the , and keys and then press the key.

Example 3: To enter 1270.680MHz,  
Press , , , , and keys and then press the key.

If there is an error in selecting a frequency, press the [PTT] key or the key and the process can be redone from the start.

## 6-5 Operating the Transceiver in the Preset Mode

1. In the VFO mode, while pressing the  key, the reception mode will be indicated on the display and the transceiver will switch to Preset mode.

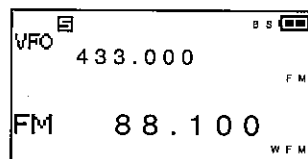

2. Choose the band you want to monitor by pressing the  key.

Each time the  key is pressed, the display switches as shown in the illustration on the right.

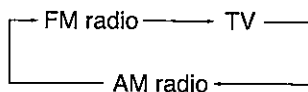

3. Choose a frequency (or TV channel) by rotating the sub dial.

## 6-6 Reception

1. Select a frequency in any of the operation modes. When a frequency you want to monitor is received, **BUSY** and the signal strength level is indicated on the display and you can listen to the received audio. At the same time, the RX light is green.

### ● The frequency range is as follows:

The received frequencies on the main band are:

144MHz band: from 136.000 to 169.995MHz

430MHz band: from 420.000 to 469.995MHz

1200MHz band: from 1240.000 to 1299.995MHz

The received frequencies on the sub band are

from 0.530 to 1299.995MHz (T/EG-versions)

from 0.522 to 1299.995MHz (E-version)



MEMO

•E-version's coverages are limited to the amateur radio bands and broadcasting bands only.

## 6-7 Transmitting

Transmitting can only be done on the main band.

1. Tune a frequency in the selected band.
2. When the [PTT] key is pressed, the red light illuminates to indicate the transceiver is transmitting.
3. Speak in a normal volume approximately 5 centimeters away from the built-in microphone on the front of the transceiver while pressing the [PTT] key.
4. Upon releasing the [PTT] key, transmitting will stop and the transceiver will return to the receive mode.



CAUTION

•When transmitting with the operating frequencies set in V-V, U-U or 1200-1200 bands, [RX disabled] will appear on the display and reception will stop on the sub band temporarily.

•When the [MONI] key is pressed while the [PTT] key is pressed, a Call Tone signal can be transmitted.

•When talking into the microphone, if your voice is too loud or you're talking too close to the microphone, the modulation may be distorted.

•Because the transceiver is manufactured to be water resistant, a special cloth material covers the built-in microphone. For this reason, the receiving station may hear transmitted voices slightly differently using the built-in microphone in comparison to using an optional external microphone. This is not a product malfunction.

•When the [PTT] key is pressed outside the transmission frequency range, [TX disabled] will appear on the display and a beep will be heard. Transmission cannot occur when this message is displayed.

•When transmitting while scanning on the sub band, scanning will stop temporarily. After the transmission is finished, scanning will start again.



MEMO

•Please refer to P.113 "Specifications" for the details of frequency range.

## 6-8 Tone Call Function

To use the Tone Call function:

- To transmit a tone, press the [MONI] key while pressing the [PTT] key.
- The default tone frequency is 1750Hz and can be changed in the Set mode (P.81 may be incorrect – please check.)
- When transmitting the tone, the CTCSS/DCS tones will halt temporarily.



MEMO

- The Tone Call function allows access to tone burst system amateur repeaters (often used in Europe).

## 6-9 Repeater Function

Repeaters (automatic relay stations) may be installed on the roof of a building or on mountains to allow communicating with radio stations far apart. Communications through a repeater are often possible with relatively low transmission output.

By tuning the received frequency to a repeater frequency, the Repeater function operates automatically.

### ●Repeater Frequency Table

VHF:



145.200-145.495MHz	-0.6MHz
146.610-146.995MHz	-0.6MHz
147.000-147.395MHz	+0.6MHz

UHF:

442.000-444.995MHz	+5MHz
447.000-449.995MHz	-5MHz

1.2G:

1270-1275.995	+12MHz
1282-1287.995	-12MHz
1291-1292.995	-20MHz

Reverse operation is possible by pressing the  key. The repeater function releases temporary and you can transmit on the frequency originally used for the repeater downlink while monitoring the uplink frequency. Press  again to go back to the normal repeater mode. The shift-direction icon flashes during the reverse operation.



MEMO

- You may set the CTCSS tone, shift width and direction manually also. Please refer page 53 for manual tone and page 61 for manual shift setting.

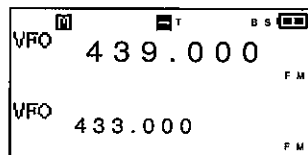

## 7.Memory Mode

The Memory mode is used to recall often used frequencies and settings registered (by the user) in the transceiver's memory.

"Banks" are places where a group of frequencies are categorized and registered so they can be easily recalled and "channels" are specific frequencies that have been registered.

### 7-1 The Types of Memories and How to Use Them

– DJ-G7 has the following 7 banks:

General Memory Bank	This is a memory bank that stores and recalls frequencies in the Memory mode. Up to 1,000 channels can be registered. When often-used frequencies are registered, recalling them is easy.
Program Scan Bank	This bank is used for the Program Scan function that searches for signals within a defined range of frequencies. 50 pairs of frequency ranges (upper point and lower point) can be registered.
Bank for Dual frequency Memory	This bank allows recalling the main band and sub band simultaneously. Up to 100 frequency pairs can be registered in the dual band.
Priority Bank	This bank is used for the Priority function (priority reception). Up to 100 Priority channels can be registered.
Call Channel Bank	The Call channels can be registered in this bank.
Search Pass Memory Bank	This bank will store up to 100 channels that can be skipped during VFO or Program scan operation. This bank is convenient when you want the receiver to skip noise or unwanted signals.
Transmitter Detecting Function Bank	This is a special bank that recalls frequencies when using the Transmitter Detecting function. The frequencies for up to 100 channels can be registered.
Bug Device Detecting Function Bank (T-version only)	Frequencies often used by bugging devices are registered in this bank. You can't register or delete these memories. Memory Skip is the only change that may be entered.



CAUTION

The same frequencies cannot be registered multiple times in the search pass memory bank. If you attempt to do so, an error beep will be heard.

## 7-2 Registering Memory Channels

The steps for registering memories in the DJ-G7 are as follows:

### 1. Set the frequency and other operating parameters you want to register in VFO mode.

The following can be registered in a memory channel:

- Frequency
- Tone frequency
- DCS codes
- Modulated-carrier frequencies
- Modulation mode
- Tone squelch/reverse tone squelch/DCS/modulated-carrier canceller
- Memory name
- Skip settings
- Shift settings

### 2. Press the key. Memory-related characters appear on the display as shown on P.42.

### 3. Rotate the dials and select the banks and channels that you want to register by ref

- When registering on the main band, select the banks and the memory channels with the lower and upper knobs of the main dial.
  - When registering on the sub band, select the banks and the memory channels with the lower and upper knobs of the sub dial.
- When a memory channel is already registered, **MR** will be indicated on the display.

#### •Banks

Select the banks according to the uses.

The relationship with banks and memories is as follows:

0~9	Banks for normal memories.
PRG	Bank for Program Scan.
DUAL	Bank for dual. The main band and the sub band are coupled and registered in one memory.
PRIO	Bank for priority.
CALL	Bank for Call Channel.
PASS	Bank for Search Pass Memory.
TSF	Bank for Transmitter Detecting function.
BUG*	Bank for the Bug Device Detecting function (this bank can't be edited).

(\* T/EG-versions.)

#### •Memory Channels



The memory channels that can be registered according to the types of banks are as follows:

0~9	From 000 to 099
PRG	From 0A to 49B
DUAL	From 000 to 099
PRIO	From 000 to 099
CALL	144MHz band call channel: VHF 430MHz band call channel: UHF 1200MHz band call channel: 1.2
PASS	From 000 to 099
TSF	From 000 to 099

### 4. Register by pressing the key.

It returns to the former operating mode after registering.

#### Example: When registering 145.000MHz from the main band on Bank 1 in the 002 channel.

1. On the main band, select the VFO mode and tune to 145.000MHz.
2. Press the  key.
3. Rotate the main lower dial and set the bank to "1".
4. Rotate the main upper dial and set the memory channel to "002".
5. Press the  key and the registration is done.



- It is not possible to overwrite memory channels. To delete or edit memory channels, you must cancel or temporarily release the "Over Write Function (P.92)" before performing such actions.
- By downloading free software from our website (<http://www.alinco.com>) and using the optional PC connecting cable (ERW-7/ERW-4C), memory channel allocations within the 50 banks can be modified up to the 1,000 channel capacity of the radio. This operation cannot be done with simple button operations on the transceiver.



- "Dual Bank" can only be selected when two bands are displayed simultaneously.
- Banks for Program Scan Channels register two frequencies such as 00A and 00B.  
For example: When 145.020MHz is registered on 01A and 146.100MHz is registered on 01B;  
When using Program Scan, the receiver will scan within the range of 145.020MHz to 146.100MHz.

### ●Memory Registration related displays

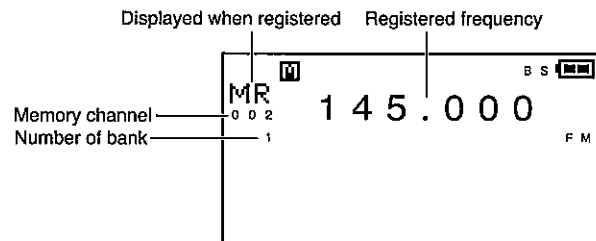

MEMO

- Expanding the memory cannot be done.
- Registered memory channels can be displayed in alphabet letters, symbols, numeric, hiragana, katakana and Chinese characters instead of frequencies. Please read "Memory Name Function P.47)" for details.
- Recalling a memory channel can be done either by dial operation or keypad input.

7

### 7-3 Recalling Memory Channels

- 1.Press the key to select the Memory mode.
- 2.Press either the key or the key to select the memory bank you want to recall.
- 3.Rotate the dial and select the memory channel.



CAUTION

- When recalling data in the bank for dual, switching between the main band and the sub band cannot be done.
- Frequencies outside the range of the main band can't be indicated on the main band with the memory channel registered in the sub band. Please read the range of frequencies for the main band in "Reception (P.36)".

**Example:** When recalling 145.000MHz registered in 002 channel in bank 1 in the main band:

- 1.Set the main band as the operation band, and select the Memory mode by pressing the key.
- 2.Press the key and set it to bank "1".
- 3.Rotate the upper dial and set the channel to "002". The information registered in the memory channel will be displayed.

### 7-4 Deleting Memory Channels

- 1.Set the "Over Write Function (P. 92)" to "accepted" or "fail-safe".
- 2.Press the key to select the Memory mode.
- 3.Select the memory channel that you want to delete.
- 4.Press the key and the is shown on the display.
- 5.When the key is pressed, an indication of confirmation will be shown (see the illustration in the right).
- 6.When the key is pressed, the contents of that memory channel will be deleted. If any other key is pressed, the operation will be cancelled.

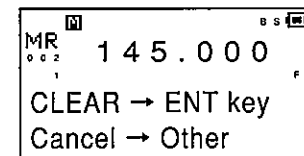

CAUTION

- Data can't be recovered once it is deleted. Please be careful not to delete necessary data by mistake.
- After deleting data, set the "Over Write Function (P.92)" back to "prohibited" in order to protect important data.
- If you execute the "All Reset (P.108)", all data will be deleted.







MEMO

- When turning the transceiver on while the Over Write feature is set to "fail-safe", it will automatically be reset to "prohibited".

7

## 7-5 Moving Memory Channels



The memory channels in registered banks (from 0 to 9) can be moved to other banks (from 0 to 9).

1. Press the  key to select the Memory mode.
2. Select the memory channel that you want to move.
3. Press the  key.
4. Press the  key.
5. Rotate the dial and select the bank and the memory channel you want to move it to.  
If you select a memory channel that is already registered, **MR** will be shown on the display.
6. Press the  key.  
The memory channel moves.



- When you overwrite and register memory channels, set the "Over Write Function (P.92)" to "accepted" or "fail-safe".
- If you press the [PTT] and the  keys, the moving of memory channels will be cancelled.

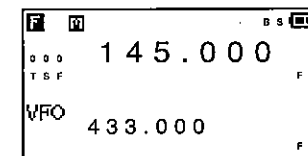

## 7-6 Registering Memories for the Transmitter Detecting Function

1. Set to the frequency you want to register in the VFO mode.
2. Press the  key.
3. Rotate the lower dial and select the bank for the Transmitter Detecting function.  
Select the bank that shows "TSF" on the left of the display.
4. Rotate the upper dial and select the memory channel.
5. Press the  key.  
The memory will be registered.



## 7-7 Registering the Call Channel



Channels used most frequently for seeking a QSO, repeater frequencies and club channels can be registered in the call channel.

1. Select the frequency you want to register to the VFO mode.
2. Press the  key.
3. Rotate the lower dial and set it to the call bank you want to register it into.  
Channels will be selected automatically with respect to the selected band.
4. Press the  key.  
Register it in the memory channel, and the radio will return to the former mode.





- When you want to overwrite and register the memory channels, set the "Over Write Function (P.92)" to "accepted" or "fail-safe".
- The frequencies that can be registered in the call channel are limited to amateur radio band frequencies.
- The Call Channel can be edited but can't be deleted.

## 7-8 Quick Memory

This function is used to quickly recall memory channels most used in the Memory mode. The Quick Memory can be registered using keys from  to .



### 7-8-1 Registering the Quick Memory

1. Press the  key to select the Memory mode.
2. Select the memory channel you want to register in the Quick mode.
3. Press any key on the keypad from  to  continuously (for approximately one second).  
To release the Quick Memory, repeat steps 1 and 3 as shown above.



•When editing the memory channels registered in the Quick Memory, the edited changes will be reflected in the Quick Memory.

### 7-8-2 Recalling the Quick Memory



1. Press any key from  to  on the keypad.
2. Press the  key.



•The Quick Memory can be recalled from any operation mode.

## 7-9 Memory Skip Function







The Memory Skip function skips memory channels without receiving them when memory scanning. This is useful in that scanning will stop on broadcast stations and for memory channels that transmit modulated-carriers. By skipping such channels, the scanning function is maintained.

1. Press the  key to select the Memory mode.
2. Select a memory channel that you want to skip.
3. Press the  key.  
**MR** changes to **SKIP** on the left side of the display, and the Memory Skip function will be set.  
Select the object memory channel and repeat the steps above to release the Memory Skip function.  
**SKIP** will change to **MR** and the Memory Skip function will be released.

## 7-10 Memory Name Function

You may name the memory channels you have programmed with any combination of up to 8 uppercase or 16 lowercase alphanumeric, Japanese and other symbol characters. Naming the memories with callsigns and station names etc will greatly help operating in the memory mode.

### ●Registering a memory name

1. Press the  key to select the Memory mode.
2. Press the  key and confirm that the  icon is displayed.
3. Press the  key several times and set the Memory Name mode.  
“Edit Name” will be shown on the display.
4. Input the characters or numbers using the keypad.  
Respective characters or numbers are shown on the keypad.  
Please refer to the “Character and Numbers Allotted on the Keypad (from P.48 to P.50)” for details.
5. When rotating the lower dial, the cursor for inputting characters can be moved.
6. For deleting characters, you can delete them one by one by pressing the  key.  
For deleting all characters, press the  key.

### ●Inputting memory names

Characters and numbers are allotted on the keypad shown in the tables from P.48 to P.50.  
By pressing the keys on the keypad, the characters will be displayed in order.  
After pressing the keys on the keypad, by rotating the upper dial the characters will be shown in order. By rotating the dial continuously, Chinese characters will be displayed.

Input example: When inputting “DJ-G7!”

1. Rotate the upper dial and set it to “D”.
2. Rotate the upper dial and set it to “J”.
3. Rotate the upper dial and set it to “-”.
4. Rotate the upper dial and set it to “G”.
5. Rotate the upper dial and set it to “7”.









## 8-3 Attenuator Function

This function is used when the received signal is affected by other strong signals. When the attenuator is set, the intensity of the targeted signal will be reduced but other signals that affect the signal of your target will become weaker at the same time. This will allow you to listen to the targeted signal more clearly. The attenuation amount may be selected from 4 different levels, with a maximum attenuation of 15dB.

1. Press the  key and **F** will be lighted on the display.

2. When the  key is pressed, [Attenuator] will be displayed.

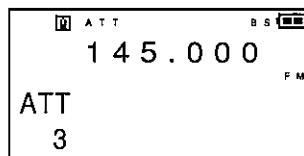

3. Rotate the upper dial and turn the attenuator off or select the intensity in a range from 1 to 4.

The attenuation amount can be selected in the order from "1" (low) to "4" (high).





•The Attenuator function operates on both the main band and the sub band.

## 8-4 Modulation Mode Setting

Although DJ-G7 has been programmed with appropriate modulation mode according to standard band-plans, the mode you wish to receive can be selected manually also.

1. Tune to the frequency on MAIN band and press  key. **F** appears on the display.

2. Press  key. [Modulation mode] and current mode setting will be indicated. Rotate the upper dial and select a mode.

3. The operation is the same for SUB band, but requires to press  key each time to switch between AUTO and mode selection.

Available modes are AM, NFM (narrow FM) and FM.



MEMO

•Some restriction may apply to the selection depending on the band. Switching to AM is not available on the MAIN band. Switching to AM/NFM/FM in WideFM (WFM/broadcast) band or vice-versa is not available. Switching to the WFM manually is not available due to the circuit design of DJ-G7.

## 8-5 Tone Squelch Function/DCS Function Settings

There are two ways to receive calls from particular stations such as club members and local stations, through the use of the Tone Squelch (CTCSS) function or the DCS function.

When you transmit using previously selected tone signals, these functions allow signal reception by opening the squelch only when the tone signals of your station and the tone squelch or DCS code signals of another party's station correspond with each other.

When receiving in dual band mode, the tone squelch function or the DCS function will only be valid on one band.



•The tone squelch function and the DCS function can't be used at the same time.

### 8-5-1 Tone Squelch Function

There are three types of tone squelch functions:

Tone (CTCSS encode):

This function can be set only to encode. It can be used to access a repeater.

Tone Squelch (CTCSS ENC./DEC.):

By using the encoder/decoder functions, you can use the selective receive option.

Reverse Tone Squelch (CTCSS E/D REV.):

This is a setting for the decoder function and the squelch closes only when there are tones.

1. Press the  key and light **F** on the display.



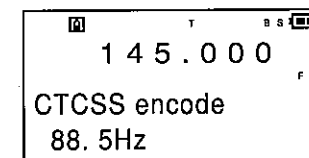

2. Press the  key several times and select "CTCSS encode", "CTCSS ENC./DEC." and "CTCSS E/D REV.".



### 3.Rotate the upper dial and select the tone frequencies from those below.

<Available tone frequencies>								(units displayed: Hz)
67.0	69.3	71.9	74.4	77.0	79.7	82.5	85.4	
88.5	91.5	94.8	97.4	100.0	103.5	107.2	110.9	
114.8	118.8	123.0	127.3	131.8	136.5	141.3	146.2	
151.4	156.7	162.2	167.9	173.8	179.9	186.2	192.8	
203.5	210.7	218.1	225.7	233.6	241.8	250.3		

When the [PTT] key or the  key is pressed, the setting process ends.  
When the tone frequency corresponds, the [TSQ] indicator is shown in reverse typeface.

4.To cancel the Tone Squelch function, press the  key and light the  on the display. Press the  key several times, and select [OFF] and the Tone Squelch function will be cancelled after pressing the  key.





CAUTION

•When using the tone squelch, also adjust the regular squelch to a normal level. If the squelch is kept open, it will take additional time for the tone squelch to operate.

## 8-5-2 DCS Function

This function allows selective reception similar to the Tone Squelch function. Any of 104 different DCS codes can be selected.

1.Press the  key and the  is lit on the display.

2.Press the  key several times and select [DCS].

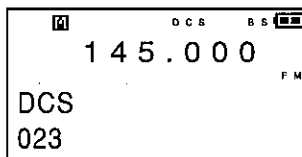

### 3.Rotate the upper dial and select the DCS code.

The DCS code can be selected from any of the following:

023	025	026	031	032	036	043	047
051	053	054	065	071	072	073	074
114	115	116	122	125	131	132	134
143	145	152	155	156	162	165	172
174	205	212	223	225	226	243	244
245	246	251	252	255	261	263	265
266	271	274	306	311	315	325	331
332	343	346	351	356	364	365	371
411	412	413	423	431	432	445	446
452	454	455	462	464	465	466	503
506	516	523	526	532	546	565	606
612	624	627	631	632	654	662	664
703	712	723	731	732	734	743	754

To complete the setting process, press the [PTT] key or the  key.

4.To cancel DCS, repeat the same and select [OFF].



MEMO

•The frequencies that can be used for the DCS function are as follows in both the main band and the sub band;

From 136.000 to 169.995MHz

From 420.000 to 469.995MHz

•Please refer to "DCS Operation Settings (P.89) for setting squelch operation while operating the DCS function.

## 8-6 Channel Scope Function

The Channel Scope function indicates activity and relative signal strength of transmissions on adjacent frequencies or memory channels. It can be used on the VFO or Memory modes and the activity status of multiple frequencies or memory channels can be quickly observed.

### Normal operation

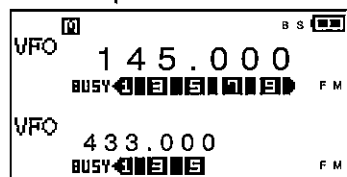

The received signal level of the indicated frequency is displayed as above.

### When using the Channel Scope function

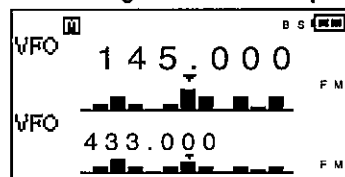

The received signal levels of up to 11 frequencies are displayed in the longitudinal direction with the currently selected channel (indicated frequency) (▼ is lighted) positioned in the center.

### Channel Scope Function Operation

Visually displays the received levels of neighboring channels. (Audio is not available at this time)

Set the displayed bar to the center channel (indicated frequency) and when there is a signal, you will be able to monitor the audio.

- If there is no signal being received by the center channel, the Channel Scope function automatically scans 11 frequencies and continues to update the visual display.
- When there is a signal on the center channel you may receive it, depending on the Scan Type (P.93) you have selected.
- When the Timer Scan is selected, the Channel Scope function will update the displayed neighboring channels at the selected interval. If audio is being received on the center channel, the received audio will be briefly interrupted. When the Busy Scan setting is selected, the neighboring channels will not be updated while the center channel is receiving a signal.
- When the Time Assignment Scan is selected, the scope indication will renew at each given time interval regardless of whether or not there are signals being received on the center channel.

### Channel Scope Operation When Using Tone Squelch or DCS. (Receiving the center channel in the normal mode)

When the Tone Squelch or the DCS is set, scanning stops when there is a signal on the center channel, and if the tone or DCS corresponds, received audio can be heard.

### Types of Channel Scope Operations

- (1) Channel Scope can operate in either the VFO or Memory Mode.
- (2) When operating in mono band on the main band side, the received audio will not break up regardless of the scan setting.

### 8-6-1 VFO Channel-Scope

This function displays the received signal levels in accord with the Channel Step that is currently selected. Each displayed channel will be one or more of the selected steps away from the displayed center channel.

#### 1. Set the band to display the scope in the VFO mode.

2. Press the **OFF FUNC** key and light **F** on the display.

3. Press the **SCOPE** key.

The VFO Channel Scope will be displayed.

#### 4. Rotate the dial and select the center channel.

The center channel goes up or down by one channel and by one tuning step. According to this movement, the scope indication drifts to the left or right side, one at a time.

#### 5. Repeat above 2 and 3 to cancel this function.

### How to Use the VFO Scope Display

Example: When the Channel Scope is active and the Channel Step is 20kHz on the main band.

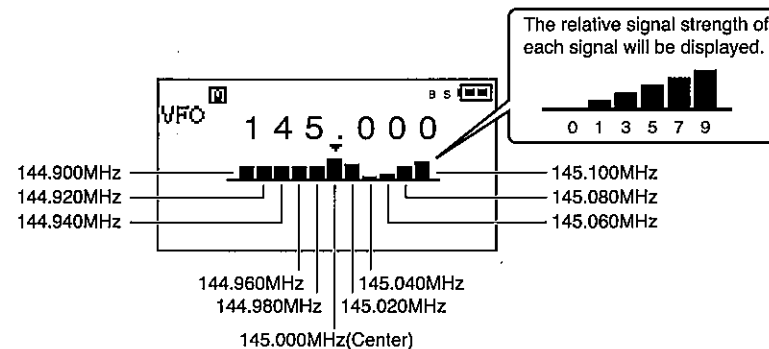

## 8-6-2 Memory Channel Scope

This function displays the received levels of frequencies in neighboring registered memories with the frequency of the indicated memory at the center.



CAUTION

- Unoccupied memories will not be displayed in the Memory Channel Scope mode.
- When there are no registered memory channels in a bank, the Memory Channel Scope function will not operate.

1.In the Memory mode, select the bank you want to display in the Channel Scope.

2.Press the key and light **F** on the display.

3. Press the key.

The Memory Channel Scope function starts. It will display the received signal levels of registered memories adjacent to the center channel while receiving the indicated memory (on the center channel).

4.Rotate the dial and select a different center channel

The center channel will go up or down and move to the next registered memory. Depending on which direction you move the dial, the scope will move to the left or right, one channel at a time.



MEMO

•You can transmit by pressing the [PTT] key even while you are using the Channel Scope. The Channel Scope function temporarily stops when you transmit. The transmitter output level will be shown in a lateral direction in place of the scope display. When transmitting is complete, the Channel Scope will start again.

•Press the key and light **F**, and when pressing the key, the receiving operation of the center channel will change as follows:

**[Normal mode]** When receiving on the center channel, audio output and the amount of receive time will be in accord with the receive time found in "Scan Mode Settings (P.93)". When starting the Channel Scope feature, the transceiver will return to normal mode every time it is activated.

**[Indication mode]** The levels of the center channel and other channels will be displayed, and there will be no audio output, even when a signal is received.

•By pressing the or the keys, the operating bands will switch. As you change the operating band while using the Channel Scope, the feature remains active on the new band. You may also use it when operating in dual band mode.

## 8-7 Changing the Channel Steps

Channel steps can be defined as the intervals between frequencies of amateur radio stations and/or radio and TV stations. The default frequency of the channel step can be changed. The increments of channel steps can be selected from the following:

### ●Channel steps that can be selected

Auto \*, 5kHz, 6.25kHz, 8.33kHz, 10kHz, 12.5kHz, 15kHz, 20kHz, 25kHz, 30kHz, 50kHz, 100kHz, 125kHz, 150kHz, 200kHz, 500kHz and 1MHz  
\* "Auto" can't be selected on the main band.

1.Select the band for which you want to adjust the channel step.

2.Press the key and light **F** on the display.

3.When pressing the key, "Channel step" will be indicated.

It will be displayed as shown in the illustration on the right.

4.Rotate the upper dial and select the appropriate channel step. When rotating the sub band dial, press the key and select the desired channel step.

On the main band

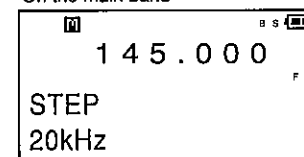

On the sub band

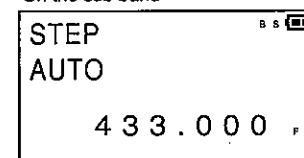

## 8-8 Microphone Gain Setting

The transmitted microphone gain can be adjusted in four steps. The microphone gain can also be adjusted depending on the volume at which the operator is speaking and by adjusting the distance between the operator's mouth and the microphone.

1.the key and light **F** on the display.



2.When the key is pressed, "Microphone gain" will be indicated.

3.Adjust the microphone gain by rotating the upper dial.

The microphone gain can be adjusted from 1 (quiet)↔4 (loud).

## 8-9 Recalling the Call Channels



This function allows recalling call channels that have been previously stored. It can be selected from any operating mode.



1. Press the  key and light **F** on the display.
2. Select a call channel by rotating the upper dial while pressing the  key.  
When releasing the  key, the frequency is changed to that of the call channel.

•Recalling the call channel is only valid on the main band.

## 8-10 Priority Function

This is a function that allows automatically monitoring two channels alternately. When using the Priority function in the VFO mode, you will receive a selected channel for five seconds (\*1), and the designated priority channel will be received for 0.5 seconds to check for the presence of a signal. The Priority function is convenient to use when monitoring channels that you frequently listen to. The main band and the sub band can be operated independently in the Priority mode.

1. Press the  key and light **F** on the display.
2. Select the priority channel while pressing the  key and rotating the upper dial.
3. When you release the  key, the Priority function operates.  
When the priority channel is received, a beep will be heard and reception will continue until the transmission has concluded.

4. The Priority function can be stopped by pressing either the [PTT],  or the  keys.

- When there is no memory registered in the priority channel, the Priority function does not operate.
- When the Priority function is operating, scanning is disabled.
- When active, the priority channel is monitored every five seconds (\*1), the audio on the main channel is interrupted at intervals when the priority channel is being monitored. These interruptions are normal and not due to a malfunction of the transceiver.

\*1 The intervals on the priority channel can be changed in the "Priority Duration Setting (P.94)" in the Set mode.

\*2 The time stopped when receiving signals on the priority channel can be changed by the "Priority Duration Setting (P.94)" in the Set mode.

## 8-11 Shift Setting

In conventional repeater systems, a signal received on one frequency is retransmitted on another frequency. The difference between these two frequencies is called the offset frequency. The selectable offset frequency of this unit is from 0 to 99.995MHz.

1. Press the  key, and while **F** is displayed, press the MAIN key several times to display the current offset frequency and shift direction setting [+]  
or [-]:

A (-) means that the TX frequency is lower than the RX frequency.

B (+) means vice versa.

2. Rotate the upper main dial while the shift frequency is being displayed.

Clockwise: each click increases the frequency by one tuning step.

Counter-clockwise: each click decreases the frequency by one tuning step.

Press the FUNC key and rotate the dial to increase or decrease the frequency in 1MHz steps.

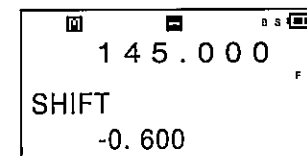

**Note:** In the event that the transmitting frequency goes beyond the amateur radio band by setting an out of band shift, [TX disabled] is shown on the display and transmission is disabled.



•Please refer 8-5 Tone squelch function (P.53) / Tone encode to set CTCSS or DCS required for repeater access.

## 8-12 Copying a Memory Channel to the VFO Mode

When you want to seek or move a QSO by shifting the frequency slightly from that of the memory channel, you can move the frequency of the memory channel to the VFO, which then allows you to move up or down from the memory channel frequency.

1. In the memory mode, select the memory channel you wish to move to the VFO mode.

2. Press the  key and light **F** on the display.



3. By pressing the  key, the frequency of the memory channel is copied to the VFO mode.

After copying the memory channel, the transceiver will switch to the VFO mode.

## 8-13 XBR(Cross Band Repeater) Mode (T-version only)

This mode allows the DJ-G7T to operate like a repeater using both Main and Sub Bands.

That is, when receiving a signal on one band, the DJ-G7T automatically transmits the same signal on another band simultaneously.

1. Set both MAIN and SUB frequencies/shifts/tones to the desired operating setting.
2. Press  key to display **F** on the display.
3. Press and hold  Key for about 3 seconds to activate the XBR.
4. Repeat above to exit.





MEMO

- The MAIN band setting cannot be altered in XBR mode.
- Any combination of VFO, or memory channels can be set as receiving and transmitting frequencies of the XBR as far as they are within the transmitter's coverage.
- The XBR doesn't support digital modes such as packet.
- The XBR respects the offset direction and range settings of the transceiver mode.
- The TOT function is usable but TOT penalty-time and BCLO functions become deactivated during XBR operation.

## 8-14 RIT/TXIT Operation



RIT/TXIT: RIT adjusts the receiving signal to fine-tune, TXIT adjusts the transmitting signal so that fine-tune to the receiving station's monitoring frequency. This function is available only to Main band 1200MHz operation in DJ-G7.

### [RIT setting]

1. Press  key. **F** appears on the display.
2. Press  key once or twice until [RIT] appears on the display.
3. Fine tune to the receiving frequency by rotating the upper dial. Adjustable range is +/- 1.8KHz in approx 600Hz steps.

-3 ← -2 ← -1 ← OFF → +1 → +2 → +3

### [TXIT setting]

1. Press  key. **F** appears on the display.
2. Press  key once or twice until [TXIT] appears on the display.
3. Adjust the transmitting frequency by rotating the upper right dial. Adjustable range is +/- 1.8KHz in approx 600Hz steps.

-3 ← -2 ← -1 ← OFF → +1 → +2 → +3

**Note:** Both RIT/TXIT will be reset and cancelled at power on/off of DJ-G7 and can't be programmed in the memory channel data.



# 9. Convenient Functions

## 9-1 Keylock Function

This function is used to prevent unintentionally operating the keys and/or dials when using the transceiver or when moving about. There are two ways to lock the keys and dials; the quick lock allows locking easily and the normal lock makes releasing the lock more complicated.

### 9-1-1 How to Lock Keys

#### ● Quick Lock

Press the  key continuously, to switch the Keylock function on or off.

When the Keylock function is active, the  icon appears on the display.

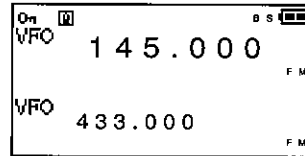

#### ● Normal Lock

Press the dial on the left side three times while pressing the  key to switch the Keylock function on or off.

When the Keylock function is active, the  icon appears on the display.

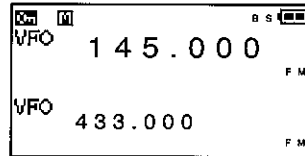

CAUTION

To release the Keylock function, follow the same steps used to activate it.

If you do not press the left dial while pressing the  key for approximately one second, the transceiver will switch from dual band to mono band or vice-versa.

### 9-1-2 Operations that are possible when the Keylock Function is active

Adjusting volume: The volume can be adjusted by rotating the lower dial.

Adjusting squelch: Squelch can be adjusted by pressing and rotating the upper dial.



Please refer to the settings of keys that can be operated while the Keylock function is active in "Key Lock Mode Settings (p.99)".

## 9-2 Scan Function







This is a function that automatically scans and searches for transmitted signals.

VFO-Scan	Scans all frequencies in the selected band by the previously set Channel Step in the VFO mode.
Preset-Scan	Scans all frequencies in the selected Preset mode band.
Memory-Scan	Scans only the frequencies registered in the Memory mode.
Program-Scan	Scans between the highest and lowest frequencies in a selected range.

#### ● These operations are common to all scanning modes:

- If you press the [PTT], ,  or the  keys, scanning will stop.
- By rotating the dial when scanning, the direction of the scan (up or down) can be changed.
- By operating the Monitor function while scanning, scanning temporarily stops. When the Monitor function is released, scanning starts again.
- The direction of scanning (up or down) is determined by the direction scanned last. (However, in the case of Program-Scan, scanning starts from the registered ○○A to ○○B)
- The parameters of scanning operations can be set. Please read "Scan Mode Settings (P.93)" to learn how to change settings.

## 9-3 VFO-Scan

1. Press the  key and set the VFO mode.
2. Rotate the upper dial while pressing the  key and select the "VFO Scan".
3. Scanning will start when the  key is released.  
The decimal indicator of the displayed frequency will blink when scanning.
4. When the [PTT], ,  or the  keys are pressed, scanning will stop.

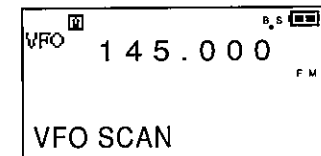

## 9-4 Preset-Scan

1. Press the **MN/C** key and select the Preset mode.
2. Select the band by pressing either the **SUB** or the **MAN** key.
3. Scanning will start when the **M-V D** key is pressed.  
The decimal indicator of the displayed frequency will blink when scanning.

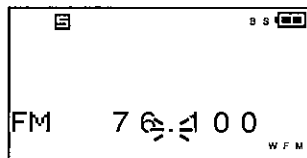

•The Preset mode for Repeater frequencies can be added by "Receiver Range Function (P.90)" on the main band.

## 9-5 Memory-Scan

You can scan a particular band or all bands while operating in the Memory mode. There are three types of Memory Scans as follows:

Mono bank scan	You can scan only the single bank you've selected
Group scan	You can scan banks previously linked
Full bank scan	All banks from 0 to 9 are scanned



MEMO

- Only banks for normal memory channels may be scanned.
- If banks have been modified using the optional software, all banks between 0 and 49 may be scanned.

1. Press the **MN/C** key and select the Memory mode.
2. While pressing the **M-V D** key, rotate the upper dial and select the type of scanning.  
The types of Memory Scan are:
  - Mono bank scan
  - Group scan
  - Full bank scan
 When the mono bank scan is selected, the bank currently in use will be scanned.
3. When the **M-V D** key is released, scanning will start.
4. If you press the [PTT], **FUNC**, **MN/C** or the **M-V D** keys, scanning will stop.

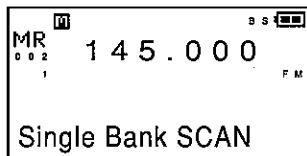

## 9-6 Program Scan

This function is used to scan a range between two (high and low) frequencies you have selected. The selected high and the low frequencies are referred to as "program channels". This transceiver allows registering 50 pairs of program channels. You must first register data in the Program Scan bank in order to perform the following operations.

1. Press the **MN/C** key and select the VFO mode.
2. Rotate the upper dial while pressing the **M-V D** key and select "Program Scan".
3. When the **M-V D** key is released, scanning will start.  
The decimal indicator of the displayed frequency will blink when scanning.
4. By pressing the [PTT], **FUNC**, **MN/C** or the **M-V D** key, scanning will stop.

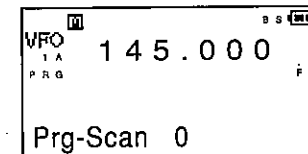

## 9-7 Tone Scan

This function automatically identifies the tone frequencies included in the received signal.

1. Set the frequency to the channel you want to check the tone in the VFO mode.
2. Rotate the upper dial while pressing the **M-V D** key and select "Tone Scan".
3. When the **M-V D** key is released, tone scanning will begin.  
Tone scanning will start and the tone frequencies will be indicated on the display in ascending or descending order. When a tone is detected, a beep will be heard, the tone frequency will be indicated and the tone scan will stop. If the tone frequencies are not detected in the received signal, the tone scan will continue until given a command to stop.
4. By pressing the [PTT], **FUNC**, **MN/C** or the **M-V D** keys, scanning will stop.

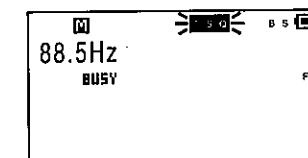
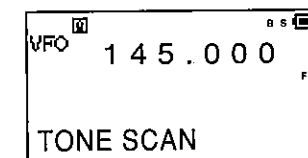



## 9-8 DCS Scan

This function identifies a DCS code included in the received signal.



1. Set the transceiver to the frequency you want to check in the VFO mode.

2. Rotate the upper dial while pressing the

 key and select "DCS Scan".

3. When the  key is released, scanning will start.

Scanning will start and the DCS codes will be displayed in ascending or descending order. When a DCS code is detected, a beep will be heard, and **d c s** and the DCS code will be indicated and the scan will stop. If a DCS code is not included in the received signal, the transceiver will continue scanning until given a command to stop.

4. By pressing the [PTT], ,  or the  keys, DCS scanning will stop.

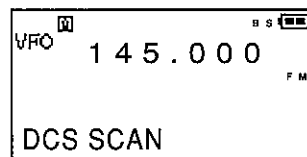

## ● How to view the level of Sweep Scan

Example: Sweep scanning in the up direction (when the channel step is 20kHz)

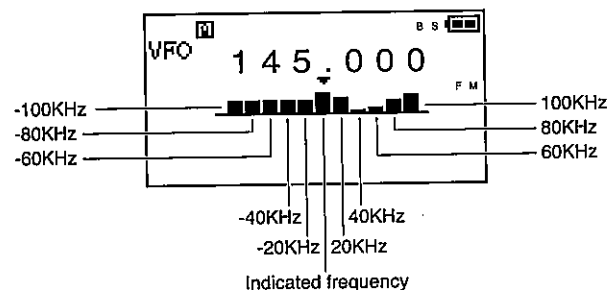

Indicates the received signal level while frequency increases by one step. The frequency levels will be displayed from the right side by one tuning step while sweep scanning, and the levels will move to the left in order. When the transceiver is scanning frequencies in a downward direction, the levels will be indicated vice versa.

While scanning, the ▼ icon will not move.



## 9-9 Sweep Scan

Sweep Scan is a function that indicates received signal levels while scanning during channel scope operation. Even if you move to the next channel, the received level of the previous channel will remain on the display. There are three types of Sweep Scan:

Band Scan, Programmed Scan and Memory Scan, the same as normal scan functions.

1. Press the  key while operating channel scope.

Sweep Scan starts. The transceiver sweep scans by the pre-selected channel step. While the Sweep Scan function is operating, the decimal point blinks and when the transceiver receives a signal at an indicated frequency, it receives the signal and will then continue scanning in accord with the selected scan function.

2. By pressing the [PTT], ,  and the  keys, the transceiver will return to channel scope operation.

## 9-10 Transmitter Detecting Function

This is a function that receives a particular frequency and indicates the relative distance to the transmitter by the strength of the detected signal. As the transmitted signal gets stronger, a beep will sound in shorter intervals (the sound heard correlates to S-meter signal strength). Use this function for fox hunting.



CAUTION

• This function operates in conjunction with the Memory mode. When using this function, it is necessary to register the target frequency into a memory channel for the Transmitter Detecting function to operate. Please refer to "Registering Memory Channels (P.40)".

1. Press the **MW C** key and switch to the Memory mode.

2. By pressing either the **MAIN** or **SUB** key and selecting the memory channel for the Transmitter Detecting function, the Transmitter Detecting function operates.

The Transmitter Detecting function will be set (the receive indicator won't light).

When using this function, received signals can't be heard.

When this function is selected, the detecting tone will automatically start to sound. However, when the tone squelch and/or the DCS are set, the detecting tone will sound only when the tone squelch frequency or DCS codes correspond.



MEMO

- When the transmitter is at close range or when the transmitter signal is strong, use the Attenuator function.
- You can hear the received signal by pressing the [MONI] key (the receive indicator will light at this time). When a microphone is attached to the transmitter, you can hear sounds around the transmitter by pressing the [MONI] key.
- Please refer to "TSF Operation Settings (P.89)" when using the dual band feature.
- The Transmitter Detecting function will operate independently of the normal squelch function.
- When the transceiver is connected to a directional antenna, it will be easier to determine the direction of the targeted signal.

# 10. Set Mode

You can customize many settings of the DJ-G7 by changing various functions to suit your needs or personal preferences. You may change settings for the following items in the Set mode. The contents of these items are called "menus" and the setting items under the menus are called "sub menus".

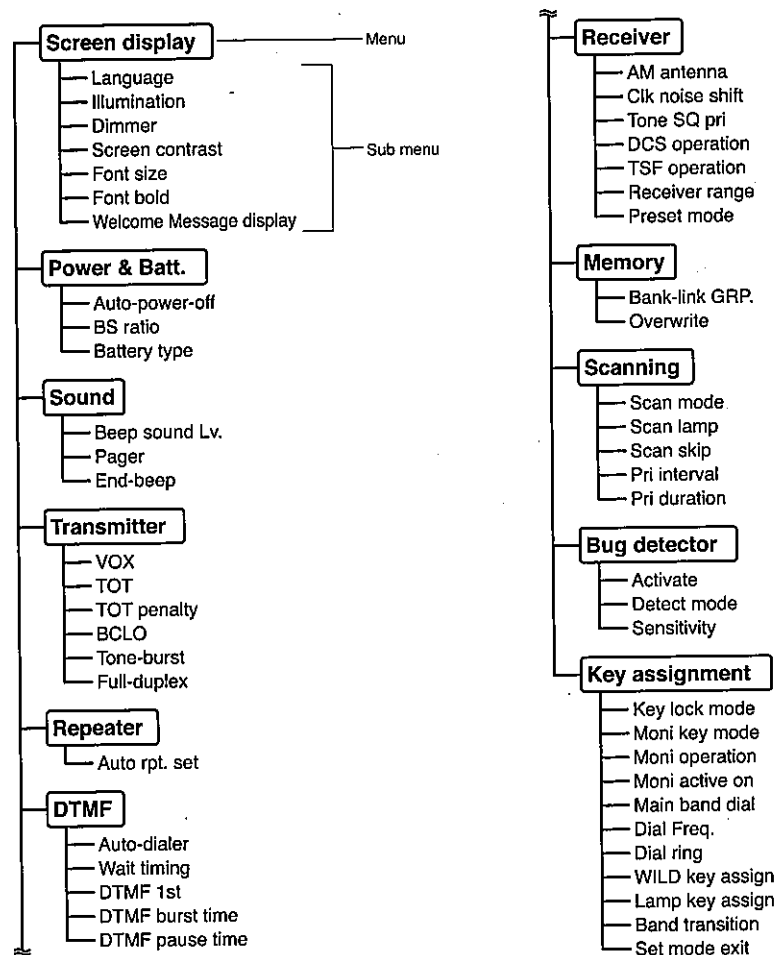

### ●How to enter the Set mode

1.Press the  key to show **F** on the display.

2.By pressing the dial, the transceiver enters the Set mode.

3.Rotate the upper dial and select the desired menu of the set mode.

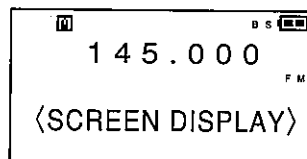

4.When you press the dial, the sub menu will be displayed.

5.Rotate the upper dial and select the sub menu; then rotate the lower dial to change the setting.

6.By pressing the [MONI] key, the display will return to the set mode menu .

7.By pressing the [PTT] key, the settings of the set mode will be in place and the procedure will be completed.

## 10-1 Screen Display

Display parameters and the illumination setting are included in this menu item.

1.Select "Screen display" from the menu of the Set mode.

2.By pressing the dial, the sub menu of "Screen display" will appear.

### 10-1-1 Language

The language can be set to either Japanese or English.

1.Rotate the dial and select "language/日本語"

"language/日本語" will be displayed as shown on the right.

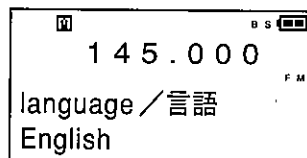

2.Rotate the lower dial and select "日本語" ↔ "English".

### 10-1-2 Illumination

The illumination settings for the display and keys can be set on or off, and the length of time the lights are on can be set. The default is five seconds.

1.Rotate the upper dial and select "Illumination".

"Illumination" and "5 Seconds" will be displayed as shown on the right.

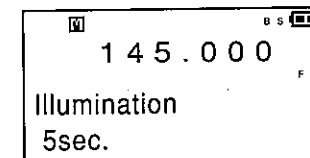

2.Rotate the lower dial and select the length of duration time .

By rotating the dial, the illumination time will switch as shown.

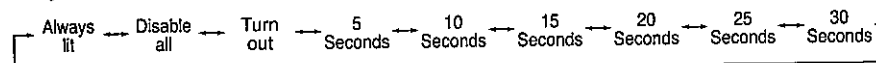

Always lit	Illumination will be permanently on.
Disable all	Illumination and the TX/RX lamps will be off.
Turn out	Illumination will remain turned off.
From 5 to 30 Seconds	Turns off the illumination after preset time has elapsed.

### 10-1-3 Dimmer

The brightness of the illuminated display and the keys can be adjusted in 5 steps. The default is 1.

1.Rotate the upper dial and select "Dimmer".

"Dimmer" will be displayed as shown on the right.

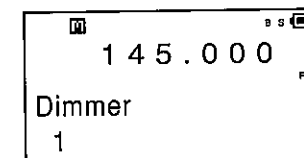

2.Rotate the lower dial and select the brightness in a range from 1 to 5.

### 10-1-4 Screen contrast

The display's contrast can be adjusted. The default is 8.

1.Rotate the upper dial and select "Screen contrast".

"Screen contrast" will be shown on the display as shown on the right.

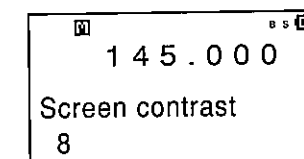

2.Rotate the lower dial and select the depth of the color of the display in a range from 1 to 10.

### 10-1-5 Font Size

You can switch the font size of the band that is not operated in dual indication.

1. Rotate the upper dial and select "Font size".

"Font size" will be displayed as shown on the right.

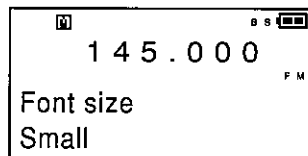

2. Rotate the lower dial and select "Small" ↔ "Large".

### 10-1-6 Font Bold

You can change boldness of the fonts used to display numbers if desired.

1. Rotate the upper dial and select "Font bold".

2. Rotate the lower dial and select the font boldness of displayed numbers.

When rotating the dial, the fonts change as shown in the illustration.



Bold all	All numbers will be displayed in boldface.
Op. band bold	Numbers on the operated band will be displayed in boldface and numbers on the non-operated band will be displayed in thin type.
OP. band thin	Numbers will be displayed in thin type on the operated band and the numbers will be displayed in boldface on the non-operated band.
Thin all	All numbers will be indicated in thin type.

### 10-1-7 Welcome Message Display

You may display up to any 16 alphanumeric characters on the DJ-G7's screen when it is powered-on as a "welcome" message.

1. Rotate the upper dial to select [Welcome/slide].

2. Press down the upper dial to enter to the edit mode.

3. Rotate the lower left dial to select how you prefer to show the message, "Slide" or "Still".

4. Rotate lower right dial to move cursor.

5. Please refer P.48 [Memory Name Function] for how to edit the characters.

**Note:** Leave it blank to display the original DJ-G7 welcome image. You may use either the original or customized message but can't skip the welcome message display.

## 10-2 Power & Batt.

Power supply settings are explained in this section.

1. Select "Power & Batt" from the Set mode menu.

2. By pressing the dial, the sub menu of "Power & Batt" will appear.

### 10-2-1 Auto-Power-Off

When active, if the transceiver has not been operated during the set-time, a beep will sound and the transceiver will automatically turns off.

1. Rotate the upper dial and select "Auto-power-off".

"Auto-power-off" will be displayed as shown on the right.

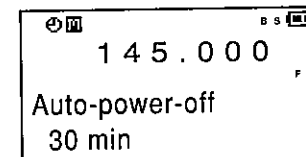

2. Rotate the lower dial and select the amount of time before the transceiver shuts down.

When rotating the dial, the Auto-power-off setting changes as shown in the illustration.

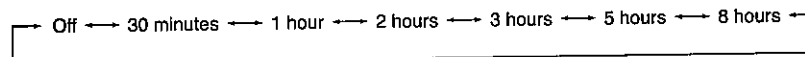

To turn the transceiver back on, press the power switch again.



•The APO (auto-power-off) time counter will not be extended by simply receiving signals, but will reset after key operations have been performed.

### 10-2-2 BS (Battery Save) ratio

This function controls battery power consumption and extends battery life between charges by turning the transceiver's internal power on and off for brief periods.

1. Rotate the upper dial and select "BS ratio".

"BS ratio" will be displayed as shown on the right.

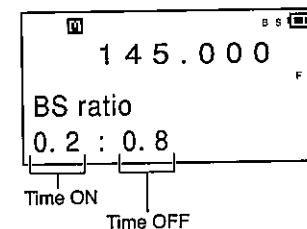

**2.Rotate the lower dial and select the time the transceiver is on and the time it is off for battery saving.**

When the BS ratio is on, **BS** will blink on the display.  
By rotating the dial, the BS ratio will switch as shown in the illustration.

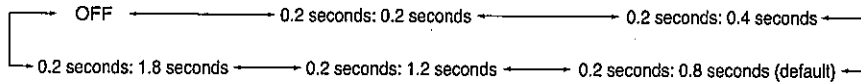

- When shipped from the factory, the BS ratio is set to 0.2 seconds : 0.8 seconds. It is not necessary to turn this function off in normal situations, but turn the BS function off when using the transceiver for packet radio communications or for receiving data such as ACARS aeronautical radio.
- The BS doesn't operate while receiving signals or when scanning.
- If you set the battery save time ratio longer, the beginning of received audio may be lost.

**10-2-3 Battery Type**

This setting is used to indicate the proper battery-level on the displayed icon.

- 1.Rotate the upper dial and select "Battery type".  
"Battery type" will be displayed as shown on the right.

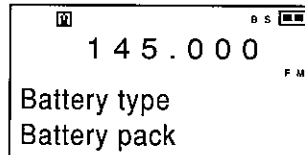

- 2.Rotate the lower dial and select "Battery Pack" ↔ "Dry Cells".



CAUTION

•If this setting is not appropriate, the battery-level (the remaining charge) will not be properly shown on the display. However, an incorrect setting of this parameter will not interfere with the normal operation of the transceiver.

**10-3 Sound**

Settings concerning sounds are explained in this section.

- 1.Select "Sound" from the Set mode menu.
- 2.By pressing the dial, the sub menu of "Sound" will appear.

**10-3-1 Beep Sound LV (Level).**

The sound heard when operating keys is called a "beep." You may select the beep volume as explained in this section. The default is 2.

- 1.Rotate the upper dial and select "Beep sound lv".  
"Beep sound lv" will be displayed as shown on the right.

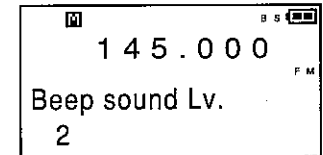

- 2.Rotate the lower dial and select the volume in a range from "OFF" or "1" to "4".  
When "OFF" is selected, the beep will not sound.



•An end-beep (see 10-3-3 below) sounds at the minimum audio level even the beep sound setting is OFF.

### 10-3-2 Pager

1. Rotate the upper dial and select "Pager".  
"Pager" will be displayed as shown on the right.

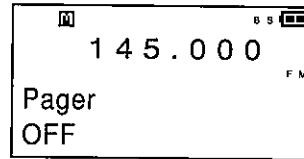

2. Rotate the lower dial and select from either "OFF", "Main Band Only" "Sub band only" or "Either Band".

When the pager is set, blinks on the display.

When the transceiver receives a signal, blinks and a bell sounds. blinks until the next operation occurs. This function can be used as confirmation of an incoming signal if you are not in proximity to the transceiver at the time it is received.

OFF	The bell will not sound.
When received on the main band	The bell will sound when a signal is received on the main band.
When received on the sub band	The bell will sound when a signal is received on the sub band.
When received on either band	The bell will sound when a signal is received on either band.

10

### 10-3-3 End-Beep

This function informs you, and those listening to your transmitted signal, that you have ended your transmission by sounding a short beep that is heard when you release the PTT.

1. Rotate the upper dial and select "End-beep".

"End-beep" will be displayed as shown on the right.

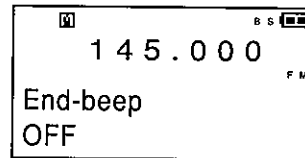

2. Rotate the lower dial and select "OFF" ↔ "ON".

### 10-4 Transmitter

The operation settings concerning transmissions of this radio are explained in this section.

1. Select "Transmitter" from the Set mode menu.

2. By pressing the dial, the sub menu of "Transmitter" will appear.

#### 10-4-1 VOX

This function allows to transmit without using the PTT by simply speaking into the microphone. When you have stopped speaking, the unit will return to receive.

1. Rotate the upper dial and select "VOX".

"VOX" will be displayed as shown on the right.

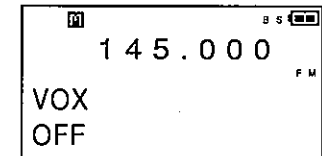

2. Rotate the lower dial and select from the VOX options.

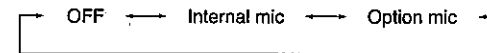

#### ●Setting the VOX sensitivity

Adjust the VOX sensitivity level. The default is 3.

1. When the VOX setting is active, press the dial two times.

The sensitivity of the "VOX Setting" will be displayed as shown on the right.

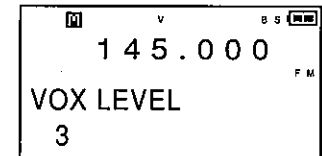

2. Rotate the upper dial and adjust for the volume of your voice when transmitting.

The VOX sensitivity can be set from 1 (low) to 7 (high). When the VOX sensitivity is set to 0, the VOX function is disabled.

**!** When the sensitivity is raised too high, there may be cases when quieter voices and/or nearby sounds are unintentionally transmitted.

**CAUTION** When the VOX is active, you can't transmit using the [PTT] key.

Even when the sensitivity is properly adjusted, there may be cases when the radio transmits when there are loud sounds nearby.

When the VOX feature is active, you can't transmit tone calls, DTMF or auto-dials.

Sub band reception is not possible when the VOX function is enabled.

10



### 10-4-2 TOT (Time Out Timer)

This function automatically stops transmission if it continues beyond a specified time.

#### ●TOT Setting

##### 1.Rotate the upper dial and select "TOT."

"TOT" will be displayed as shown on the right.

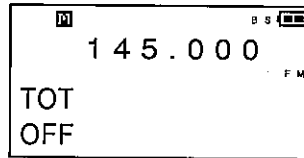

##### 2.Rotate the lower dial and select the desired TOT from a range of "OFF"↔to "450 seconds".

When the dial is rotated, TOT will switch in the increments shown in the illustration.

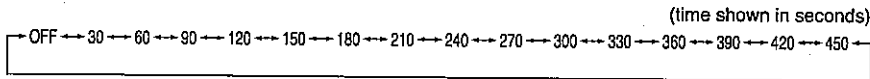

MEMO

•Just before the time exceeds the specified limit, a beep will sound and the transceiver will switch to the receive mode. When this occurs, you must release the [PTT] and press it again to resume transmitting.

•When a TOT penalty time is set, you can't transmit by pressing the [PTT] key until the specified penalty time has elapsed. Please refer to "TOT Penalty (P.80)" to set the TOT penalty time.

### 10-4-3 TOT Penalty

This function sets the TOT penalty time that prevents transmitting for a specified period of time after transmitting has been stopped by the TOT. The default is OFF.

##### 1.Rotate the upper dial and select "TOT penalty".

"TOT penalty" will be displayed as shown on the right.

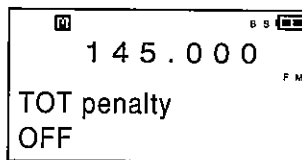

##### 2.Rotate the lower dial and select the TOT penalty time from a range of "OFF"↔to "15 seconds".

Transmission will not occur during the time period designated in the TOT penalty. If the [PTT] key is pressed during the TOT penalty period, a beep will sound.

### 10-4-4 BCLO (Busy Channel Lock Out)

This function is used on the main band and restricts transmission when another signal is present on the same frequency.

##### 1.Rotate the upper dial and select "BCLO".

"BCLO" will be displayed as shown on the right.

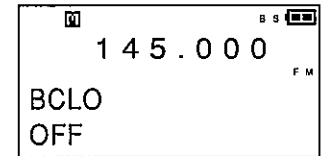

##### 2.Rotate the dial and select "on"↔"off".

When the Busy Channel Lock Out function is on, transmission will be allowed in the following cases (1), (2) and (3), and you can only transmit under these conditions:

- (1)When a signal is not present
- (2)When the tone squelch is active.
- (3)When the DCS squelch function is active.

### 10-4-5 Tone-Burst

##### 1.Rotate the upper dial and select "Tone-burst".

"Tone-burst" will be displayed as shown on the right.

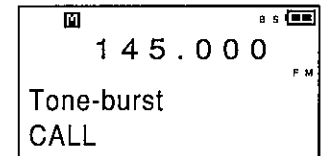

##### 2.Rotate the lower dial and select the tone frequency.

By rotating the dial, the tone frequencies change as shown in the illustration.

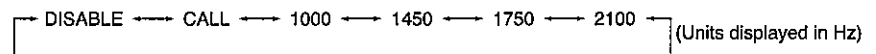

### 10-4-6 Full-Duplex Setting

In order to avoid entering receiving sound of sub-band that may cause an interference to the main-band transmission, the sub-band receive can be muted while transmitting on the main side.

##### 1.Rotate the upper main dial to select "Full-duplex" as shown.

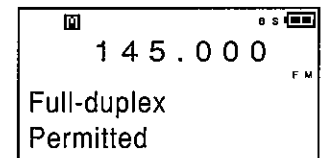

##### 2.Rotate the lower main dial to select "Permitted"↔"Prohibited".

## 10-5 Repeater

The repeater access settings are explained in this section.

### 10-5-1 Auto Repeater Set

You can select whether or not the automatic repeater access setting operates.

There are two modes in this transceiver:

- On: The transceiver will automatically apply the shift direction and frequency offset according to the standard repeater band-plans.
- Off: No offset occurs

- 1.Rotate the upper dial and select "Repeater".  
"Repeater" will be displayed as shown on the right.

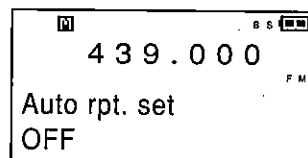

- 2.Rotate the dial and select "on"↔"off".

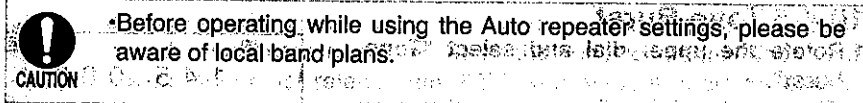

#### The standard Auto-repeater band plans

	T-version	Shift	E/EG-version	Shift
144MHz	146.610~146.995MHz	-0.6MHz	145.600~145.795MHz	-0.6MHz
	147.000~147.395MHz	+0.6MHz	N/A	N/A
430MHz	442.000~444.995MHz	+5.0MHz	N/A	N/A
	447.000~449.995MHz	-5.0MHz	N/A	N/A
1200MHz	1270.000~1275.995MHz	+12MHz	1297.000~1297.375MHz	-6.0MHz
	1282.000~1287.995MHz	-12MHz	N/A	N/A
	1291.000~1292.995MHz	-20MHz	N/A	N/A

#### ●Shift direction and offset frequencies

A repeater normally retransmits a signal received on a certain frequency to another frequency. The difference between these two frequencies is called the offset frequency.

The range of the offset frequency may be set from 0 to 999.995MHz.

When using a repeater, when the [PTT] key is pressed, the transceiver shifts from the received frequency, up or down, to the transmitted frequency monitored by the repeater.

This change in frequency (up or down) is called the shift direction.



•Please refer P.53/Tone encode or DCS to add tones. Manual change of offset/shift is suspended within the standard repeater frequencies when the auto repeater is activated.

## 10-6 DTMF (Dual Tone Multi Frequency)

This setting applies to transmitting DTMF tones (the same sounds that can be heard from the push buttons of an ordinary telephone). This function is used in accessing certain repeater functions in some areas or linking stations via the internet.

- 1.Select "DTMF" from the Set mode menu.

- 2.By pressing the dial, the sub menu of "Encoding tone" will appear.

### 10-6-1 Auto-Dialer

This section explains how to register, transmit and record DTMF tones in the memories.

Up to 16 characters can be input in one DTMF memory and 9 memory codes can be registered.

#### ●Setting the auto-dialer memory

- 1.Rotate the upper dial and select "DTMF", and press down the main dial.

"DTMF" will be displayed as shown on the right.

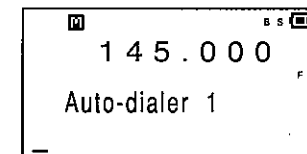

- 2.Rotate the lower sub dial and select the number of a dialer memory from 1 to 9.

- 3.Press the keypad and input the DTMF codes.

When you input the numbers, they will be displayed as follows:

The numbers will be indicated as [ 1 ]→  
[ 12 ]→[ 123 ]→[ 1234 ]→[ 12345 ]→  
[ 123456 ]. Up to 16 numbers can be input.

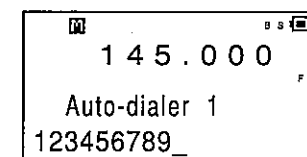

You can set the transceiver to pause instead of sending tones by pressing the key while inputting the code and then pressing the key while is displayed.

When the transceiver is in the pause position, "-" will be displayed.

When the transceiver is set to pause, it will not transmit a signal for approximately one second, corresponding with the pause position.

Press the key and press the key while is displayed in order to delete all of the DTMF codes that were input.

- 4.The input codes will be automatically recorded. The transceiver will return to the Operation mode by pressing the [PTT] key.

●Auto Dialer output

The DTMF codes will be heard from the speaker, but will not be transmitted.

1.Repeat the previously described steps in the Set mode and select the code you want to sound.

2.Press the **ENT** key after pressing the **FUNC** key.

3.The DTMF code that is indicated on the display will be output from the speaker.

If the DTMF code is not memorized, it will not be output from the speaker.

●Auto dialer transmission

1.Press the **[PTT]** key and begin transmitting.

2.Press the **FUNC** key and “D” will appear on the display.

3.By pressing any key from **WILD** to **CALL**, the DTMF codes registered in the correlating DTMF memory will be automatically transmitted.

When a numerical key is pressed that has no DTMF codes registered, DTMF codes will not be transmitted.

●Redial function

1.Press the **[PTT]** key, and begin transmitting.

2.Press the **FUNC** key.  
“D” will be indicated at the top of the display.

3.Press the **PRI** key.  
The last DTMF code sequence (the DTMF code transmitted manually) will be transmitted automatically. DTMF tones will be heard from the speaker.



•If there has been no DTMF output after shipping or resetting the transceiver, the redial function will not operate.



•The timing relative to DTMF functions is set from “10-6-2” to “10-6-4” is shown as follows;

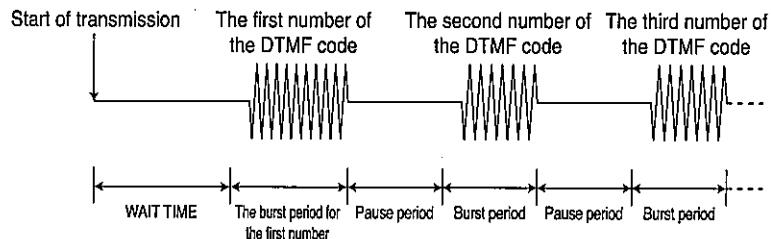

10-6-2 DTMF WAIT Time

When the auto dialer is sending DTMF tones, a tone will be sent after the WAIT time setting. The default is 100 milliseconds.

1.Rotate the upper dial and select the “DTMF WAIT time”.

“DTMF WAIT time” will be displayed as shown on the right.

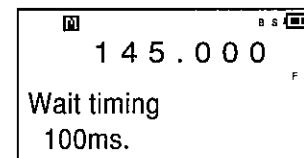

2.Rotate the lower dial and select the DTMF WAIT time in increments of 100 milliseconds ranging from 100 to 1,000 milliseconds.

When rotating the dial, the DTMF WAIT time will switch as follows;

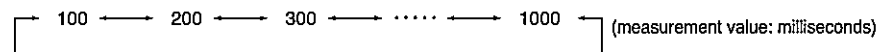

10-6-3 DTMF Burst Period for the First Number

When DTMF code is output by the auto dialer, the code output will start from the burst period for the first number set.

1.Rotate the upper dial and select “DTMF 1st”.

“DTMF 1st” will switch through a range of values from 20 ms to 2 seconds.

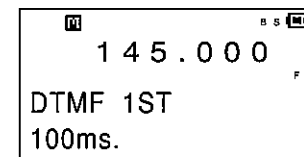

2.Rotate the lower dial and select the burst period for the first DTMF number.

When rotating the dial, the burst period will switch as follows.

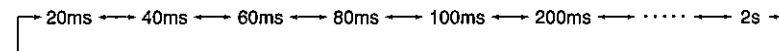

10

10

### 10-6-4 DTMF Burst Time

When the auto dialer is sending DTMF tones, they will be output by the burst time set. The default is 100 milliseconds.

1. Rotate the upper dial and select "DTMF burst time".

"DTMF burst time" will be displayed as shown on the right.

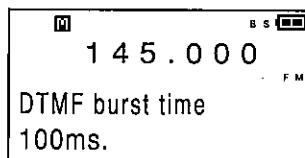

2. Rotate the lower dial and select the DTMF burst time in a range from 20 ms to 2 seconds.

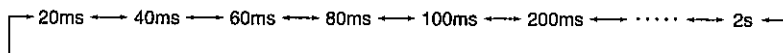

### 10-6-5 DTMF Pause Time

When the auto dialer is sending DTMF tones, they will be output by the pause time set. The default is 100 milliseconds.

1. Rotate the upper dial and select "DTMF pause time".

"DTMF pause time" will be displayed as shown on the right.

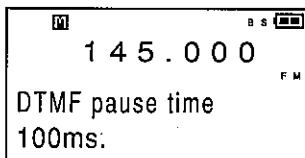

2. Rotate the lower dial and select the DTMF pause time in a range from 20 ms to 2 seconds.

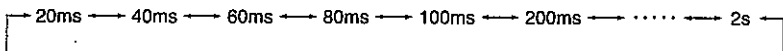

## 10-7 Reception Settings

The settings of certain reception parameters are explained in this section.

1. Select "RECEIVER" from the Set mode menu.

2. By pressing the dial, the Receiver settings sub menu will appear.

### 10-7-1 AM Antenna Settings

When you want to receive an AM radio station, you may switch between the external antenna or the built-in AM antenna.

1. Rotate the upper dial and select "AM antenna".

"AM antenna" is displayed as shown on the right.

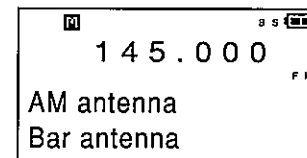

2. Rotate the lower dial and select between "Bar Antenna" ↔ "External".

The default antenna for AM broadcast reception is the internal bar antenna. When you use an external antenna, connect it to the SMA connector on the transceiver.

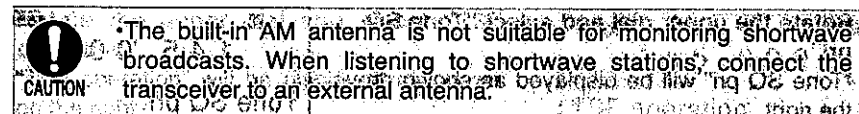

### 10-7-2 Clock Noise Shift Settings

If a faint noise is always heard in a particular frequency, there is a possibility that it is due to processor clock noise. Clock noise cannot be eliminated due to the design of circuits in the unit, but this transceiver allows to move the noise to a different frequency making reception of the desired signal possible.

1. Rotate the upper dial and select "Clk noise shift".

"Clk noise shift" will be displayed as shown on the right.

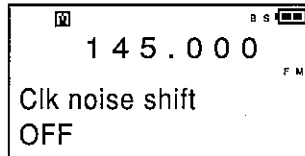

2. Rotate the lower dial and select between "ON" ↔ "OFF".



MEMO

This feature is different from the noise blanker function. Please be aware that not all noises are due to clock noise, and therefore using the clock noise shift function may not always be effective.

### 10-7-3 Tone SQ Priority Settings

When receiving in the dual band mode, tone squelch (TSQ) and DCS settings will be valid on only one band. This parameter will allow you select how those features are applied.

1. Rotate the upper dial and select "Tone SQ pri".

"Tone SQ pri" will be displayed as shown on the right.

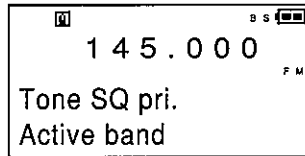

2. Rotate the lower dial and select the priority.

By rotating the dial, the priority will switch as shown.

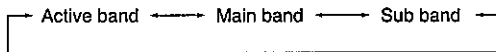

Active band	The transceiver will give tone and DCS priority to the band that is active.
Main band	The transceiver will give tone and DCS priority to the main band. (It will give priority to the band indicated at the top of the display)
Sub band	The transceiver will give tone and DCS priority to the sub band. (It will give priority to the band indicated at the bottom of the display)

### 10-7-4 DCS Operation Settings

There are cases when the squelch closes due to DCS settings and/or receiving conditions.

In such conditions, you can change the DCS setting from normal to hold. This operation allows opening the squelch by using a DCS code and closes the squelch by normal squelch.

1. Rotate the upper dial and select "DCS operation".

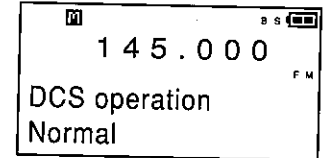

2. Rotate the lower dial and select between "normal" ↔ "Hold".



CAUTION

When set to the keep position, in a case where the squelch opens by acknowledging a DCS code, the squelch will remain open until all transmissions on that frequency have concluded.

### 10-7-5 TSF Operation Settings

When receiving a signal on the other band while detecting transmitters on the primary band, you can set whether or not you want to temporarily suspend the transmitter detecting sound.

1. Rotate the upper dial and select "TSF operation".

"TSF operation" will be displayed as shown on the right.

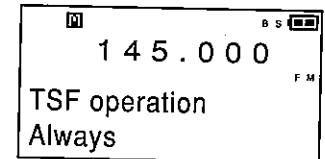

2. Rotate the lower dial and select between "Always" ↔ "Interrupt".

If the transceiver is set in the "Interrupt" position, the transmitter detecting sound will break off when you receive a signal from the band that is operating in transmitter detection mode.

### 10-7-6 Receiver Range Function

This mode will limit operation to the amateur bands of both the main band and the sub band in the VFO mode of this transceiver. The mode is not limited in the Memory or Preset modes.

1. Rotate the upper dial and select the "Receiver range".
2. Rotate the lower dial and select the range of the operation frequencies.

Wide band RX	All of the frequencies that can be operated on this transceiver will be displayed.
Amateur bands	The amateur band frequencies will be displayed.

When set to "Limited to amateur bands", a Preset mode specialized for repeater frequencies will be added to the main band and appears "PS" on the display (T-version only).

### 10-7-7 Preset Mode Settings

This setting is used when you do not want to access the Preset mode.

1. Rotate the upper dial and select the "Preset mode setting".
2. Rotate the lower dial and select between "Activate" ↔ "Deactivate".

•When you select "Deactivate", the Preset mode on both the main band and the sub band will be suspended.

## 10-8 Memory Settings

Memory function settings will be explained in this section.

1. Select "Memory Settings" from the Set mode menu.
2. By pressing the dial, the memory settings sub menu will appear.

### 10-8-1 Bank-Link Setting Function

When scanning the memories, you can combine the banks that you want to scan into scanning groups. 10 pairs of groups and one specialized group for bug device detecting can be set, and the 10 pairs correspond to keys from  $\text{PRIO}$   $\text{0}$  to  $\text{CALL}$   $\text{9}$ , and the bank for bug device detecting corresponds to the  $\text{SUB}$   $\text{B}$  key.

●How to set the bank link function.

1. Rotate the upper dial and select "Bank link".

2. Press the keys from  $\text{PRIO}$   $\text{0}$  to  $\text{CALL}$   $\text{9}$  or  $\text{SUB}$   $\text{B}$  and select the group number you want to edit.

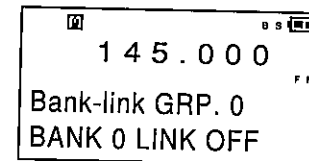

3. Rotate the lower dial and select the bank you want; the group will be registered by pressing the  $\text{RPT}$   $\text{ENT}$  key and by indicating "Yes" on the display. By pressing the  $\text{RPT}$   $\text{ENT}$  key again, "No" will be displayed, and the operation is cancelled.

•When confirming the details of a specific group, select the group and rotate the lower dial. The links of respective banks will be indicated.

## 10-8-2 Over Write Function

This function allows editing (overwriting and deleting) channels registered in the Memory mode. Default setting is "Prohibited".

### 1.Rotate the upper dial and select "Overwrite".

"Overwrite" will be indicated on the display as shown on the right.

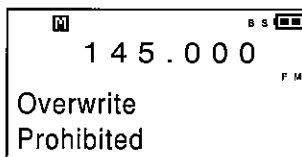

### 2.Rotate the lower dial and select one of the overwrite settings.

When rotating the dial, the settings will switch as shown in the illustration.



Accepted	This setting will make the Overwrite function valid. Memories registered can be edited.
Prohibited	This setting will make the Overwrite function invalid. Memories registered cannot be edited.
Fail-safe	Memories registered can be edited. When turning the transceiver on again, the setting will return to be fault that is "prohibited".

Please read "Deleting Memory Channels (P.43)" to learn how to delete memory channels.

## 10-9 Scanning Settings

Various scanning functions are explained in this section.

### 1.Select "Scanning" from the menu of the Set mode.

### 2.By pressing the dial, the scanning settings sub menu will appear.

## 10-9-1 Scan Mode Settings

You can set the conditions under which scanning will resume after stopping for a monitored signal.

### 1.Rotate the upper dial and select "Scan mode".

"Scan mode" will be displayed as shown on the right.

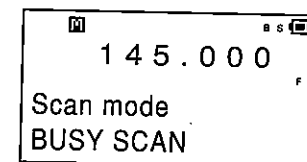

### 2.Rotate the lower dial and select from "Busy scan" to "1 second timer" to "25 seconds timer" to "1 second elapse" to "5 minutes elapse".

Set the scan mode according to the table below.

Busy scan mode	Scanning will resume if there is no signal after stopping the scan.
Timer scan mode	Scanning will resume when the selected time is up even when receiving a transmission.
Elapsed Time setting scan mode	This function will resume scanning when the selected time is up regardless of whether or not there is a signal. This function will operate even when the squelch is open. The time to stop scanning can be set from 5 seconds to 5 minutes.



MEMO

- The time setting scan mode automatically moves to the next channel when the set time is up regardless of whether or not there is a signal. As this mode operates even when the squelch is open, it is a useful function when receiving data communications such as ACARS (Aircraft Communication Addressing and Reporting System), when you want to receive data from multiple channels at a particular time interval and when you want to scan while still taking time to monitor every channel.
- This function can be used in the VFO mode, the Preset mode and the Memory mode.

### 10-9-2 Scan Skip Settings

You can select whether to skip the frequencies registered in the search pass memory channels or those memory channels designated for skipping.

The frequencies registered in the search pass memory channels will be skipped during VFO scans, Program scans and Preset scans (excluding TV channels), and the memory channels designated for skipping will be skipped when scanning memories.

When scanning memories, the frequencies registered in search pass memory channels won't be skipped.

1. Rotate the upper dial and select "Scan skip".

"Scan skip" will be displayed as shown on the right.

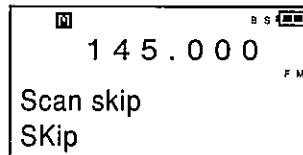

2. Rotate the lower dial and select between "Valid" ↔ "Suspend".

### 10-9-3 Priority Interval Setting

This section explains how to set priority intervals in the Priority function.

1. Rotate the upper dial and select "Pri interval".

"Pri interval" will be displayed as shown on the right.

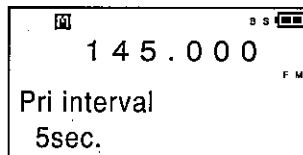

2. Rotate the lower dial and select an interval in a range from 5 to 60 seconds.

### 10-9-4 Priority Duration Setting

This section explains how to set the time allowed to receive priority channels in the Priority function.

1. Rotate the upper dial and select "Pri duration".

"Pri duration" will be displayed as shown on the right.

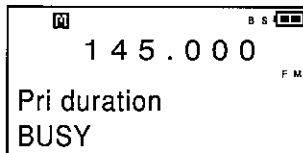

2. Rotate the lower dial and select between "Busy" ↔ or from "1 second" to "25 seconds".

### 10-9-5 Backlight Setting While Scanning

The display and keys can be illuminated when scan stops in the scan mode. This is useful for scan operation in the dark.

1. Rotate the upper dial to select [Scan lamp].

2. Rotate the lower dial to select [ON] or [OFF] of the function. When [ON] is set, the display and key illumination will be lit at each squelch-opening during scan operations.

**Note:** The [Always lit] parameter in illumination setting mode (P.73) will be disregarded and illumination turns off when [ON] is selected in this menu. The illumination stays lit until the scan resumes in accordance with the scan mode setting. Stop scanning to turn off the backlight.

### 10-10 BUG Detector Settings (T-version only)

This function automatically scans frequencies that are likely to be used by bugging devices and searches them.

There are two modes, "silent" and "sound", in this transceiver.

You can search for bugging devices by combining banks of registered memories with banks specialized for bugging device detection.

1. Select "Bug detector" from the menu of the Set mode.

2. By pressing the dial, the sub menu of the bug detector functions will appear.



MEMO

- Please read "Detect Mode Settings (P.98)" to learn how to switch from the "silent" mode to the "sound" mode.
- The searching sensitivity can be set for bug detecting in the silent mode. Please read "Sensitivity Settings (P.98)" for details.
- When using the Bug Detector function, you search the memory channels in the banks combined with the bank of the Bug Detector function. Please read the "Bank-Link Setting Function (P.91)" for details.



CAUTION

- These functions are facile and don't guarantee any security. The manufacturer declines any responsibilities against not detecting bugging devices.
- The manufacturer doesn't provide any service for detecting bugging device and disposing of bugging devices.
- The local dealers don't accept general consultations concerning bugging device detecting except the functions and operations of this transceiver.



## 10-10-1 Activate Settings

### 1. Rotate the upper dial and select "Bug detector".

"Bug detector" will be displayed as shown on the right.

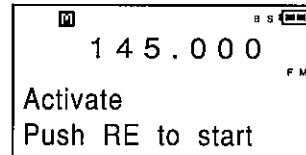

### 2. Press the dial.

### 3. By pressing the [PTT] key, the Bug Detector function will be released.

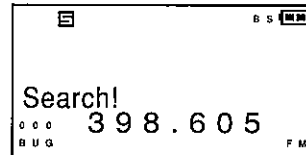

### ● Searching in the silent mode.

This mode searches for a bugging device with a high degree of accuracy by outputting a received sound when the transceiver receives a signal and outputting an unpleasant sound when the signal is transmitted from a bugging device.



CAUTION

- Do not use earphones when operating in this mode.
- There may be cases when scanning stops due to errors that are affected by noises. If the cause of the noise is a bugging device, sounds near the transceiver will be heard as unpleasant sounds.

### 1. Press the dial.

The transceiver will automatically begin scanning. While scanning, there will not be a beep. If the transceiver determines that there is a bugging device, a warning beep will sound and an alarm message will be indicated on the display as shown on the right. If sounds near the transceiver are heard, there is a possibility that a bugging device is set up. (Please be careful in this case as the sound will be louder.)

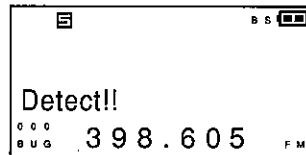

### 2. Rotate the sub dial (lower) and allow the volume to be adjusted.

The volume of this transceiver is adjusted to output an unpleasant sound for detecting bugging devices. Do not cover the speaker in this case.

### 3. Move the transceiver slowly.

The unpleasant sound will be louder as the transceiver draws close to the bugging device and quieter as the transceiver draws away from the bugging device.

### 4. Press the [PTT] key.

This function will be released.

### ● Searching in the sound mode

This mode detects a bugging device and determines the rough distance to the bugging device by outputting a sound from the transceiver, making the bugging device transmit the sound and measuring the time lag until the transceiver receives the signal. The characteristic of this mode is to inform the user of the distance to the bugging device by a sound and an indication when it determines that there is a bugging device. While searching in this mode, a loud sound will be heard.



CAUTION

- Do not use earphones when operating in this mode.
- The valid distance for the Bug Detector function is approximately from 1 to 5 meters.
- The Bug Detector functions are largely affected by sounds near the transceiver, the strength of the signal of the bugging device and the sensitivity of the microphone. There are cases when the transceiver produces improper operating signals and/or can't be used in particular environments (such as where sounds rebound).
- If you abruptly move the transceiver while searching for a bugging device, it may produce improper operating signals due to the Doppler effect.
- There are cases when the Bug Detector functions don't operate properly due to the positional relationship between the direction of the speaker and the bug detector.
- In cases when you receive signals at 2300MHz, the Bug Detector function will not operate properly.

### 1. Press the dial.

Scanning will resume automatically. A consecutive sound will be heard while scanning.

In the case of scanning in an assigned area within a certain period of time, "stop" will be indicated on the display and the searching will be complete.

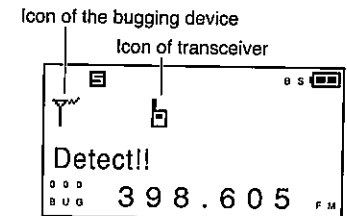

### 2. Move the transceiver slowly, and search a place where a bugging device is likely to be set.

When the transceiver determines that there is a bugging device, it will output 3 short sounds.

When the transceiver comes close to the bugging device, the space of the icon becomes narrower and the interval between the sounds becomes shorter. When the transceiver draws apart from the bugging device, the space of the icon widens and the interval between the sounds becomes longer.

**3.Press the [PTT] key.**

This function will be released.



The scanning time may be longer when searching for bugging devices by combining frequencies that are usually used for bugging devices with frequencies you want to search in the bank for bugging device detecting. Please refer to P.90 for details.

**10-10-2 Detect Mode Settings**

This section describes the search modes of the Bug Detector.

**1.Rotate the upper dial and select "Detect mode".**

"Detect mode" will be displayed as shown on the right.

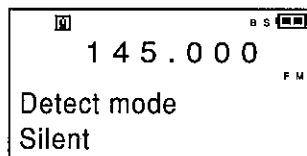

**2.Rotate the lower dial and select between "silent"↔"sound".**

Please read the details of detect mode in "BUG Detector Settings (T-version only) (P.95)".

**10-10-3 Sensitivity Settings**

This article explains the searching sensitivity of the bug detector function in the silent mode.

**1.Rotate the upper dial and select "Sensitivity".**

"Sensitivity" will be displayed as shown on the right.

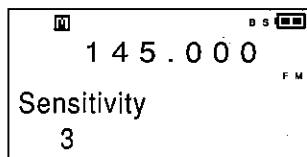

**2.Rotate the lower dial and select between "1"↔"5".**

The default is 3.

The sensitivity of the bug detector can be selected in order from "1" (low) to "5"(high).



When the sensitivity is set high, it is likely to cause errors. If the sensitivity is low, the risk of errors will be reduced although the response will become weak if the transceiver is not near the bug device.

**10-11 Key Assignment**

The settings of the key assignments for this transceiver are explained in the following:

**1.Select "Key assignment" from the Set mode menu.**

**2.By pressing the dial, the key assignment sub menu will appear.**

**10-11-1 Key Lock Mode Settings**

This section explains the allocation of the keys and dials that are to be locked.

**1.Rotate the upper dial and select "Key lock mode".**

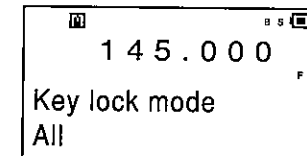

**2.Rotate the lower dial and select the type of key lock mode.**

Every time the dial is rotated, the modes switch as follows;

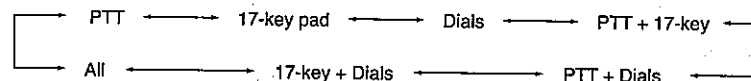

PTT	The [PTT] key will be locked.
17-key pad	Keypad operations will be locked.
Dials	Dial operations will be locked. *
PTT + 17-key	The [PTT] key and keypad operations will be locked.
PTT + Dials	The [PTT] key and dial operations will be locked.
17-key + Dials	Keypad and dial operations will be locked.
All	All operations will be locked.

\* The "volume", "squelch" and the [MONI] key can be operated.

### 10-11-2 Moni Key Mode Setting

When pressed, the [MONI] key can be set to either monitor mode or mute mode.

1. Rotate the upper dial and select "Moni key mode".

"Moni key mode" will be displayed as shown on the right.

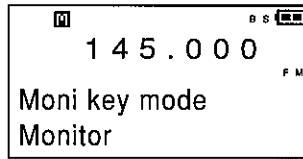

2. Rotate the lower dial and select between "monitor" ↔ "mute".

Monitor	When the [MONI] key is pressed, the squelch will open temporarily.
Mute	When the [MONI] key is pressed, the sound will mute temporarily.

### 10-11-3 Moni Operation Settings

The operational settings when the [MONI] key is pressed are explained in this section.

1. Rotate the upper dial and select "Moni operation".

"Moni operation" will be displayed as shown on the right.

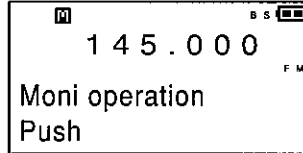

2. Rotate the lower dial and select between "Push" ↔ "Hold".

Push	The monitor function or the mute function will operate while the [MONI] key is being pressed.
Hold	Press the [MONI] to activate, repeat to cancel the operation.

### 10-11-4 Setting the Bands Subject to MONI Key Operations

The bands subject to the operation of the [MONI] key can be set.

1. Rotate the upper dial and select "Moni operation".

2. Rotate the lower dial and select the bands subject to {MONI} key operations.

Both bands	The [MONI] key will operate on both bands.
Main-band only	The [MONI] key will only operate on the main band.
Sub-band only	The [MONI] key will only operate on the sub band.
Operating band	The [MONI] key will function on the selected operating band.

### 10-11-5 Mainband Dial Setting

This setting switches the functions of the dials on the left and the right sides.

1. Rotate the upper dial and select "Mainband dial".

"Mainband dial" will be displayed as shown on the right.

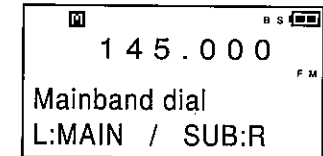

2. Rotate the lower dial and select between "Left: Main Sub: Right" ↔ "Left: Sub Main: Right".

### 10-11-6 Dial Function Setting

This setting switches the functions of the dials on the upper and the lower sides.

1. Rotate the upper dial and select "Dial".

"Dial" will be displayed as shown on the right.

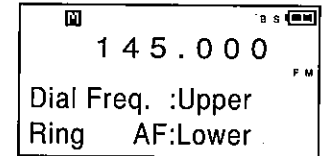

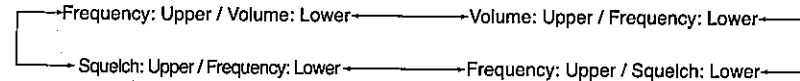

2. Rotate the lower dial and select the functions of the upper and lower dials. When rotating the dials, the functions will switch as follows:



The functions of volume and squelch that are not assigned by rotating the dials can be adjusted by pressing them.

### 10-11-7 Short-cut (Wild) key Setting

●Optional menus in the Set mode can be assigned to the  key. If you set the menus frequently used in the  key, you can change the settings quickly.

1.Rotate the upper dial and select "Wild key".

"Wild key" will be displayed as shown on the right.

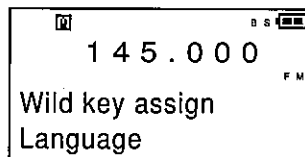

2.Rotate the lower dial and select the function you want to assign to the  key.

●Optional menus in the Set mode can be assigned to the [LAMP] (MONI) key. If you set the menus frequently used in the [LAMP] key, you can change the settings quickly.

1.Rotate the upper dial and select "Lamp key assign".

"Lamp key assign" will be displayed as shown on the right.

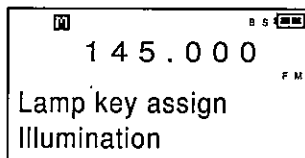

2.Rotate the lower dial and select the function you want to assign to the [LAMP] key.

### 10-11-8 Band Transition Setting

When the displayed frequency is at the top or bottom of a band, you can elect to return to the other end of the same band or choose to move to the next band while scanning or manually tuning in the VFO mode on the sub band.

1.Rotate the upper dial and select "Band transition".

"Band transition" will be displayed as shown on the right.

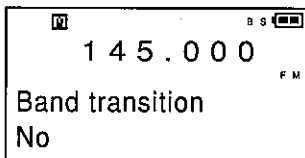

2.Rotate the lower dial and select between "Yes"↔"No".

Yes	The frequency returns to the other end of the same band.
No	The frequency moves to the next band.

### 10-11-9 Set Mode Exit Setting

This function allows the Set mode to turn off automatically when there have been no operations for a given period of time. You can select from manual and automatic (from 5 seconds to 5 minutes).

1.Rotate the upper dial and select "Set mode exit".

"Set mode exit" will be displayed as shown on the right.

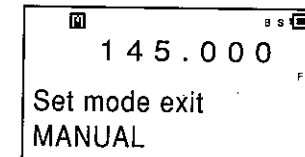

2.Rotate the lower dial and select between "Manual"↔from "5 seconds" to "5 minutes".

Manual (default)	The transceiver will wait until the  or the [PTT] key is pressed.
From 5 seconds to 5 minutes	The Set mode will turn off if keys are not operated within the selected time. The changed settings will be saved.

# 11.Channel Indication Mode

This mode displays just the bank and channel number of a memory channel, instead of frequencies, and limits other functions in the memory mode.

1.Memories must have been registered previously.

2.Set the transceiver to the memory mode and turn it off.

3.Turn the transceiver on while pressing the **SCAN** and the [PTT] keys.

The display will be shown as on the right.

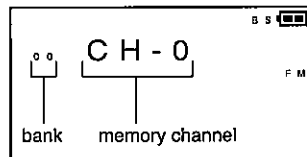

To exit the channel indication mode, turn the transceiver off, and turn it on while pressing the **SCAN** and the [PTT] keys.



MEMO

- When the transceiver is in the channel indication mode, operations are limited to changing the banks and channels, adjusting the volume, adjusting the squelch, MONI/MUTE function operations, memory scan operations and keylock operations.
- When a channel name is registered, the channel name will be displayed.
- Even when the transceiver is reset, the channel indication mode can't be released unless the procedure described above is performed again.

# 12.Cloning / PC Connection Functions

The cloning function copies data from one DJ-G7 transceiver to another DJ-G7 transceiver. Two DJ-G7 transceivers are connected by a cable and information (including memory data) from the sending unit will be copied to the receiving unit when using this function.

The DJ-G7 can also be connected to a PC and memory channels and/or the Set mode settings can be edited using specialized software downloadable from Alinco's web-site for free.

## 12-1 How to Connect

- When using the cloning function, an optional clone cable (EDS-11) will be connected from the sender's earphone/microphone terminal to the receiver's earphone/microphone terminal.
- When connecting this transceiver to a PC, an optional microphone/speaker plug conversion cable (EDS-14) is connected to the earphone/microphone terminal of this transceiver and the plug of a PC connecting cable (ERW-7/ERW-4C) and connected to the PC.

### ●Clone cable (EDS-11)

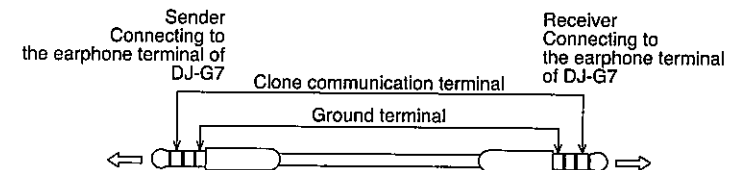

## 12-2 Operating the Transceiver Sending Data

When sending and receiving clone data between DJ-G7 transceivers, or when transferring data with a PC, follow these procedures:

- 1.Connect a clone cable (EDS-11) to the earphone/microphone terminal while the transceiver is turned off, and then turn the transceiver on.
- 2.Press and hold the [MONI] key then press the [PTT] key 3 times. The transceiver will be in the clone mode and is ready to transfer data.

When the transfer of data to another DJ-G7 transceiver is complete, the power automatically turns off and then turns on again.



CAUTION

- When transferring data, do not press any keys.
- When transferring data, do not disconnect the cables. If a cable disconnects, [ERROR] will be shown on the display of the sending transceiver and data transfer will stop.
- When using the cloning function, data in the receiving unit will be completely replaced with data of the sender. Please be careful when there is already data stored in the receiving radio.

## 12-3 Operating the Radio Receiving Data

This operation is unnecessary for radios connected to a PC.

1. With the transceiver turned off, connect a clone cable (EDS-11) to the earphone/microphone terminal of the unit that will receive data and then turn the transceiver on.

2. Press and hold the [MONI] key and press the [PTT] key 3 times.  
"CLONE" will be displayed as shown in the right.

CLONE 57600dps

3. By pressing the dial, data will be transferred to the receiver.

4. When the transfer is finished, "FINISHED!" will be displayed.  
If "ERROR" is displayed, redo from step 1.

5. Turn the power off to cancel the clone mode.  
If the power supply is not turned off, the clone mode will not be released.

## 12-4 Packet Communications

Packet communication enables data transmission and reception through a TNC (modem) unit.

### 12-4-1 Packet Communication Connections

When using this transceiver for packet communications, refer to the illustration below and connect it to a TNC following these steps:

Connect an optional EDS 14 microphone/speaker plug conversion cable to the earphone/microphone terminal at the top of this transceiver, and connect a TNC (Terminal Node Controller) to the speaker terminal (using a 3.5ø plug) and to the microphone terminal (using a 2.5ø plug).

•Adjusting the input level:

This transceiver doesn't have a function to adjust the microphone input level. Adjust that level from the TNC, if necessary.

•Adjusting the output level:

Adjust the output level from the earphone/microphone terminals using the audio output dial on the transceiver.

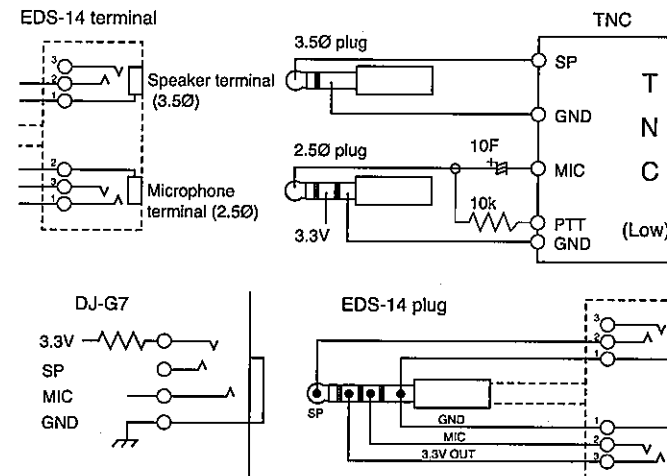

\*Voltage will be supplied through a 100 ohm resistor from the internal 3.3V line.



CAUTION

- Please follow the TNC instruction manual for information on connecting the TNC to a PC.
- If this transceiver, the TNC and the PC are in close proximity, noise may be present.
- During packet communications, turn the Battery Save function off.
- Do not exceed 1,200 bps during packet operations.

# 13.Reset Functions



•Please be careful. Data deleted from the memory mode cannot be recovered!

There are two types of reset functions in this transceiver; a partial reset function that initializes only the display and the "all reset" function that deletes memory data.

## 13-1 Partial Reset



This function doesn't initialize memory data but returns the transceiver to its factory settings.

This function is used when the transceiver is not operating properly or if the operator is confused about the transceiver's current condition.

1. Turn the transceiver off.
2. Turn the transceiver on while pressing the  key.
3. When "Reset completed" is displayed, release the key.

## 13-2 All Reset

This function is only for limited use such as resetting all memory data.

1. Press the ,  and  keys in order while turning the transceiver on.
2. When "All reset completed" is displayed, release the key.  
The transceiver will return to the default VFO mode.



# 14.Maintenance and Reference

## 14-1 Troubleshooting

The following symptoms are not malfunctions, please check the possible causes and take proper actions. If a problem persists, please reset the unit. Problems with settings and CPU-related difficulties are often resolved by a reset.

Symptom	Possible Cause	Action
Nothing appears on the display when turning on the power.	Poor battery pack connection.	Remove dirt or corrosion from the battery pack terminals.
	Battery is exhausted.	Recharge or replace the batteries in the dry cell case.
	You are releasing the power key too quickly.	Hold the power key down until the display appears.
	The [PTT] key is pressed.	Release the [PTT] key.
No speaker audio.	Volume too low.	Adjust the audio level.
	Squelch level too high.	Adjust the squelch level.
	Tone squelch is on.	Turn off tone squelch.
	DCS in on.	Turn off DCS.
	You are pressing the PTT key and transmitting.	Release the [PTT] key.
Frequency display is incorrect.	The mute function is on.	Release the mute function.
	CPU error.	Remove the external power supply and the battery pack, wait for more than 10 seconds and attach them again. If the trouble isn't resolved by following these steps, reset the unit.
Won't scan.	A channel name is set.	Refer to "Memory Name Function".
	Squelch is unmuted.	Set squelch so that noise mutes.
Frequency and memory channel number don't change.	Key lock is on.	Turn off Key lock.
Key entry not possible.	Key lock is on.	Turn off Key lock.

Symptom	Possible Cause	Action
Repeater-Access can't be used.	Incorrect setting of parameters.	Confirm the repeater settings.
Can't transmit.	Battery is exhausted.	Replace or charge the battery pack.
Display flashes or goes out when you transmit.	Not pressing the PTT key firmly enough.	Press the PTT key and confirm that the TX/RX lamp is lit red.
	The transceiver will not transmit out of the authorized band. (The shift setting is incorrect.)	Transmit within the range of authorized frequencies. Confirm the repeater settings.
	The frequency is incorrect.	Properly adjust the frequency at the other station.
The display flashes or disappears during reception.	Battery is exhausted.	Replace or charge the battery pack.

- Waterproof portions such as DC power supply jack caps are consumable items that must be replaced from time to time.
- If after-sales service or support is necessary, please contact the dealer you purchased this transceiver from. To locate your nearest dealer, please read the "US/CANADA DEALERS" or the "INT'L DISTRIBUTION" sub menus in the "DISTRIBUTION" menu of our website (<http://alinco.com/usa.html>).
- An update of firmware is possible for this product and the detail is posted on our website at <http://www.alinco.com/Products/DJ-G7/firmdown.html>. For this reason, your DJ-G7 may operate slightly different from the explanations given in this manual after such update is performed.
- In case of requesting technical assistances over the phone to your local Alinco dealer, we recommend you to identify the version of firmware in advance as follows:
  - 1:Press and hold  key for 2 seconds to lock the keys.
  - 2:Press  key 10 times consecutive. Copy the numbers that appears on the display.
  - 3:Press PTT to return to the operating mode.

## 14-2 Options

- Li-ion Battery Pack (EBP-73: 7.4V 1,200mAh)
- Dry Cell Case (EDH-35)
- Desk top charger (EDC-173)
- Desk top charging Set (EDC-173T: T-version)
- Desk top charging Set (EDC-173E: E-version)
- Desk top charging Set (EDC-173UK: EUK-version)
- AC Adapter for Charging (EDC-170: T-version)
- AC Adapter for Charging (EDC-151A: E-version)
- AC Adapter for Charging (EDC-152A: EUK-version)
- Cigar Lighter Cable for Charging (EDC-43)
- Cigar Lighter Cable with Filter (EDC-36)
- DC Cable (EDC-37)
- Speaker Microphone (EMS-59)\*
- Speaker Plug (EMS-62: Waterproof plug)
- Tie pin Type Microphone with VOX Function (EME-15A)\*
- Headset with VOX Function (EME-12A)\*
- Headset with VOX Function (EME-13A)\*
- Earphone Microphone (EME-21A: heavy duty specification)\*
- Earphone Microphone (EME-32A: heavy duty specification with waterproof plug)
- Earphone Microphone (EME-34A: tie pin-type)\*
- Earphone Microphone (EME-36A: waterproof plug)
- Straight Code Earphone (EME-6)\*
- Curled Code Earphone (EME-26)\*
- Clone Cable (EDS-11: waterproof plug)
- Microphone/Speaker Conversion Cable (EDS-14: waterproof plug)
- PC Connection Cable (ERW-4C: serial port)\* (ERW-7: USB port)\*
- Soft Case (ESC-50)



CAUTION

- When using options marked with the \*, please purchase the EDS-14 cable.
- When using external DC cables, connect the cables to the transceiver before turning it on.
- EME-32A/36A and EMS-62's microphone units are not waterproof (The plugs protect the radio from water to penetrate through the jack).

### Note: FOR EUROPEAN USERS:

Please be advised that some of the accessories listed above are not RoHS compliant at the moment this manual has been edited, and they are intended for the sales to where RoHS order is not effective. Please consult with your local dealer for any updates about RoHS compliance of our products before purchase. Use of external power source cables are your own risk per IEC/EN60950-1.



## 14-2-1 Microphone/Speaker Plug Conversion Cable (EDS-14)

1. Turn the transceiver off.

2. Rotate the plug clockwise (right). When it stops, confirm that the plug is securely connected.

3. Connect the microphone/speaker cables to their respective jacks.

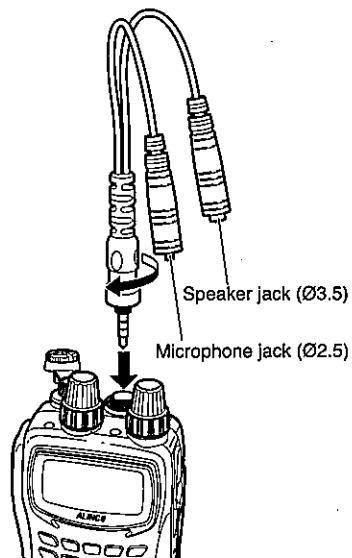

•Never use tools like pliers to screw the plugs. It may cause a serious damage to the cable and/or the unit.

# 15. Specifications

## ■General

- Frequency range: E-version TX/RX: 144.000 - 145.995MHz  
430.000 - 439.995MHz  
1240.000 - 1299.995MHz  
AM/FM/TV(analog) broadcasting bands  
T/EG-version TX: 144.000 - 147.995MHz  
430.000 - 449.995MHz  
1240.000 - 1299.995MHz  
RX: 0.530 - 1299.995MHz  
(Cellular frequencies 824.000 - 849.995MHz,  
869.000-894.995MHz blocked on T-version)
- Antenna impedance: 50 ohm (SMA)
  - Supply voltage: DC 7.4V (EBP-73 Li-Ion battery pack)  
DC 4.5~16V (external regulated source)
  - Ground: Negative ground
  - Current consumption:
    - TX approx. 1.6A/144MHz, 1.8A/430MHz, 0.8A/1200MHz
    - RX approx. 200mA
    - Battery save (1:4) approx. average : Dual 56mA/Single 50mA
  - Temperature range: -10°C~+45°C per CE (+14~+113°F)  
\* Rated Duty Cycle: 30s TX, 30s RX, 30s Standby ⚠
  - Frequency stability: +2.5ppm (@-10 - +45°C)
  - Dimensions (WxHxD Projections exclusive):  
60 x 115 x 30 mm  
or 2.36 x 4.53 x 1.18 in.
  - Weight (Antenna/EBP-73 inclusive):  
Approx. 296 g /9.55 oz

## ■Transmitter

- Output power (approx):
  - DC13.8V:144MHz/430MHz 5/2/1/0.3W, 1200MHz 1/0.3W
  - EBP-73:144MHz 5/2/0.8/0.3W, 430MHz 4.5/2/0.8/0.3W,  
1200MHz 1/0.3W
  - 4 x AA cells (Max): 144MHz 2W, 430MHz 1.5W, 1200MHz 0.5W
- Modulation mode: TX:F1D/F2D/F3E (RX only:WFM/AM)
- Spurious emission: -60dB or less
- Maximum frequency deviation: ±5KHz

■Receiver

- System: Double-conversion super heterodyne (NFM,AM)  
Single-conversion super heterodyne (WFM)
- IF frequencies (1st/2nd):
  - Main-band FM 51.65MHz / 450KHz
  - Sub-band AM/FM 50.75MHz / 450KHz
  - Sub-band WFM 10.7MHz
- Sensitivity: 144/430MHz ham-radio bands -15dB $\mu$  or better  
1200MHz ham-radio band -13dB $\mu$  or better

Sub-band receiver (Best values):

- AM (10dB S/N): Lower than 50MHz -1dB $\mu$   
50MHz and above -6dB $\mu$
- FM (12dB SINAD): 30-470MHz -15dB $\mu$   
470MHz and above -7dB $\mu$
- WFM 76-470MHz -6dB $\mu$ :  
470MHz and above -3dB $\mu$
- Selectivity: AM/FM -6dB 12KHz or more / -60dB 35KHz or less  
WFM -6dB 130KHz or more / -60dB 300KHz or less
- Audio output power: 400mW (8 $\Omega$  / 10% THD)