

**User Manual**

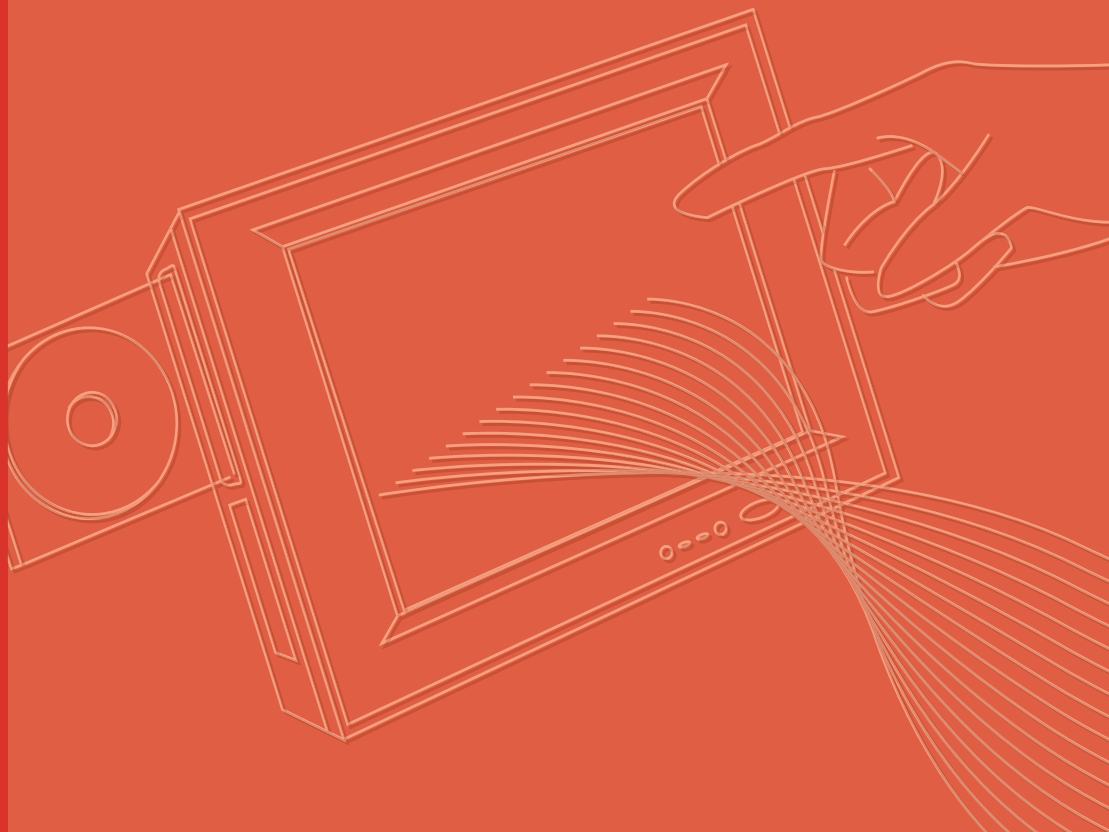

# PPC-L128T

**Intel® Atom™ N270 Processor-  
based Fanless Panel PC with  
12.1" TFT-LCD**

**ADVANTECH**

*Enabling an Intelligent Plan*

---

## Copyright

The documentation and the software included with this product are copyrighted 2011 by Advantech Co., Ltd. All rights are reserved. Advantech Co., Ltd. reserves the right to make improvements in the products described in this manual at any time without notice. No part of this manual may be reproduced, copied, translated or transmitted in any form or by any means without the prior written permission of Advantech Co., Ltd. Information provided in this manual is intended to be accurate and reliable. However, Advantech Co., Ltd. assumes no responsibility for its use, nor for any infringements of the rights of third parties, which may result from its use.

## Acknowledgements

Award is a trademark of Award Software International, Inc. Intel and Celeron are trademarks of Intel Corporation.

IBM, PC/AT, PS/2 and VGA are trademarks of International Business Machines Corporation.

Intel and Pentium are trademarks of Intel Corporation.

Microsoft Windows is a registered trademark of Microsoft Corp. RTL is a trademark of Realtek Semiconductor Co., Ltd.

All other product names or trademarks are properties of their respective owners.

For more information on this and other Advantech products, please visit our websites at:

<http://www.advantech.com>

<http://www.advantech.com/ppc>

For technical support and service, please visit our support website at:

<http://support.advantech.com>

This manual is for the PPC-L128T.

# Declaration of Conformity

## FCC Class B

Note: This equipment has been tested and found to comply with the limits for a Class B digital device, pursuant to part 15 of the FCC Rules. These limits are designed to provide reasonable protection against harmful interference in a residential installation. This equipment generates, uses and can radiate radio frequency energy and, if not installed and used in accordance with the instructions, may cause harmful interference to radio communications. However, there is no guarantee that interference will not occur in a particular installation. If this equipment does cause harmful interference to radio or television reception, which can be determined by turning the equipment off and on, the user is encouraged to try to correct the interference by one or more of the following measures:

- Reorient or relocate the receiving antenna.
- Increase the separation between the equipment and receiver.
- Connect the equipment into an outlet on a circuit different from that to which the receiver is connected.
- Consult the dealer or an experienced radio/TV technician for help.

**Warning!** *Any changes or modifications made to the equipment which are not expressly approved by the relevant standards authority could void your authority to operate the equipment.*



## Packing List

Before you begin installing your card, please make sure that the following materials have been shipped:

- PPC-L128T series panel PC
- User manual
- Accessories for PPC-L128T
  - Y-shaped adapter for PS/2 mouse and keyboard
  - Warranty card
  - DC plug-in housing (female) is connected on the AC/DC power adapter
  - Driver DVD-RW disc
  - Mounting kits and packet of screws

If any of these items are missing or damaged, contact your distributor or sales representative immediately.

## Additional Information and Assistance

1. Visit the Advantech web site at [www.advantech.com](http://www.advantech.com) where you can find the latest information about the product.
2. Contact your distributor, sales representative, or Advantech's customer service center for technical support if you need additional assistance. Please have the following information ready before you call:
  - Product name and serial number
  - Description of your peripheral attachments
  - Description of your software (operating system, version, application software, etc.)
  - A complete description of the problem
  - The exact wording of any error messages

**Caution!** *Danger of explosion if battery is incorrectly replaced. Replace only with the same or equivalent type recommended by the manufacturer. Dispose of used batteries according to the manufacturer's instructions.*



- Warning!**
1. *Input voltage rated 12 ~ 24 V, 5 A ~ 3.75 A*
  2. *Use a 3 V @ 195 mA lithium battery*
  3. *Packing: please carry the unit with both hands, handle with care*
  4. *Maintenance: to properly maintain and clean the surfaces, use only approved products or clean with a dry applicator*
  5. *CompactFlash: Turn off power before inserting or removing CompactFlash storage card.*



*Contact information:*

*Our European representative: Advantech Europe GmbH Kolberger StraÙe 7*

*D-40599 Dsseldorf, Germany*

*Tel: 49-211-97477350*

*Fax: 49-211-97477300*

# Safety Instructions

1. Read these safety instructions carefully.
2. Keep this User Manual for later reference.
3. Disconnect this equipment from any AC outlet before cleaning. Use a damp cloth. Do not use liquid or spray detergents for cleaning.
4. For plug-in equipment, the power outlet socket must be located near the equipment and must be easily accessible.
5. Keep this equipment away from humidity.
6. Put this equipment on a reliable surface during installation. Dropping it or letting it fall may cause damage.
7. The openings on the enclosure are for air convection. Protect the equipment from overheating. **DO NOT COVER THE OPENINGS.**
8. Make sure the voltage of the power source is correct before connecting the equipment to the power outlet.
9. Position the power cord so that people cannot step on it. Do not place anything over the power cord.
10. All cautions and warnings on the equipment should be noted.
11. If the equipment is not used for a long time, disconnect it from the power source to avoid damage by transient overvoltage.
12. Never pour any liquid into an opening. This may cause fire or electrical shock.
13. Never open the equipment. For safety reasons, the equipment should be opened only by qualified service personnel.
14. If one of the following situations arises, get the equipment checked by service personnel:
  - The power cord or plug is damaged.
  - Liquid has penetrated into the equipment.
  - The equipment has been exposed to moisture.
  - The equipment does not work well, or you cannot get it to work according to the user's manual.
  - The equipment has been dropped and damaged.
  - The equipment has obvious signs of breakage.
15. **DO NOT LEAVE THIS EQUIPMENT IN AN ENVIRONMENT WHERE THE STORAGE TEMPERATURE MAY GO BELOW -20° C (-4° F) OR ABOVE 60° C (140° F). THIS COULD DAMAGE THE EQUIPMENT. THE EQUIPMENT SHOULD BE IN A CONTROLLED ENVIRONMENT.**
16. **CAUTION: DANGER OF EXPLOSION IF BATTERY IS INCORRECTLY REPLACED. REPLACE ONLY WITH THE SAME OR EQUIVALENT TYPE RECOMMENDED BY THE MANUFACTURER, DISCARD USED BATTERIES ACCORDING TO THE MANUFACTURER'S INSTRUCTIONS.**

The sound pressure level at the operator's position according to IEC 704-1:1982 is no more than 70 dB (A).

**DISCLAIMER:** This set of instructions is given according to IEC 704-1. Advantech disclaims all responsibility for the accuracy of any statements contained herein.



# Contents

<b>Chapter 1</b>	<b>General Information .....</b>	<b>1</b>
1.1	Introduction .....	2
1.2	General Specifications .....	2
1.2.1	General .....	2
1.2.2	Standard PC functions .....	2
1.2.3	VGA/LCD Interface .....	3
1.2.4	Audio function .....	3
1.2.5	PCIe bus Ethernet interface .....	3
1.2.6	Touchscreen (Optional) .....	3
1.2.7	Optional modules .....	4
1.2.8	Environment .....	4
1.3	LCD Specifications .....	4
1.3.1	PPC-L128T-R80 series .....	4
1.3.2	PPC-L128T-R81 Series .....	4
1.4	Dimensions .....	5
	Figure 1.1 Dimensions of PPC-L128T .....	5
<b>Chapter 2</b>	<b>System Setup .....</b>	<b>7</b>
2.1	A Quick Tour of the Panel PC .....	8
	Figure 2.1 Front view of PPC-L128T panel PC .....	8
	Figure 2.2 Rear view of Panel PC .....	8
	Figure 2.3 Side view of the panel PC .....	9
	Figure 2.4 Bottom view of the panel PC .....	9
2.2	Installation Procedures .....	9
2.2.1	Connecting the power cord .....	9
2.2.2	Connecting the keyboard or mouse .....	9
2.2.3	Switching on the power .....	10
	Figure 2.5 Connect the power cord to the DC inlet .....	10
2.3	Running the BIOS Setup Program .....	10
2.4	Installing System Software .....	11
2.4.1	Method 1: Use the Ethernet .....	11
2.4.2	Method 2: Use the COM .....	11
2.4.3	Method 3: Use a DVD-RW .....	11
2.5	Installing the Drivers .....	11
<b>Chapter 3</b>	<b>Hardware Installation and Upgrading .....</b>	<b>13</b>
3.1	Introduction .....	14
3.2	Installing the 2.5" Hard Disk Drive (HDD) .....	14
	Figure 3.1 Installing primary 2.5" HDD .....	14
3.3	Installing the battery pack .....	15
	Figure 3.2 Installing the battery pack .....	15
<b>Chapter 4</b>	<b>Jumper Settings and Connectors ....</b>	<b>17</b>
4.1	Jumpers and Connectors .....	18
4.1.1	Setting jumpers .....	18
4.1.2	Jumpers and connectors .....	19
	Table 4.1: Jumpers and Connector functions .....	19

4.1.3	Locating jumpers and connectors.....	20
	Figure 4.1 Jumpers and Connectors on the PPC-L128T mother- board .....	20
4.2	CMOS Clear for External RTC (CN13(2-3)).....	20
	Table 4.2: CMOS clear (CN13) .....	20
4.2.1	COM1/COM2/COM3 pin 9 output setting (CN20&CN21) .....	21
	Table 4.3: COM1/ COM2 pin 9 output setting (CN20).....	21
	Table 4.4: COM3 pin 9 output setting (CN21) .....	21
4.3	VGA Interface .....	21
4.3.1	LCD panel power setting .....	21

## **Appendix A I/O Pin Assignments ..... 23**

A.1	Keyboard and PS/2 Mouse Connector (CN27).....	24
	Table A.1: Keyboard and mouse connector (CN27).....	24
A.2	USB port (CN19).....	24
	Table A.2: USB port (CN19) .....	24
A.3	COM1 RS-232 serial port (CN37).....	24
	Table A.3: COM1 RS-232 serial port (CN37) .....	24
A.4	COM2 (CN28).....	25
	Table A.4: COM2 (CN28) .....	25
A.5	COM3 RS-232 serial port (CN38).....	25
	Table A.5: COM3 RS-232 serial port (CN38) .....	25
A.6	GPIO port (CN29) .....	26
	Table A.6: GPIO port (CN29).....	26
A.7	VGA Connector (CN39) .....	26
	Table A.7: VGA connector (CN39) .....	26
A.8	PCI Bus connector (CN18) .....	27
	Figure A.1 PCI connector.....	27
	Table A.8: PCI pin assignments .....	28
A.9	PCI Express Bus connector (CN16) .....	29
	Table A.9: PCIExpress pin assignments .....	29
A.10	How to setup Teaming function on PPC-L128T-R80 series .....	30
	A.10.1 Team together .....	30
	A.10.2 Dismiss! .....	35
	A.10.3 TESTING .....	37
A.11	How to setup team function on PPC-L128T-R81 series .....	38
	A.11.1 Create team function .....	38
	A.11.2 Remove Teaming Flow.....	42



# Chapter 1

## General Information

This chapter gives background information on the PPC-L128T panel PC.

Sections include:

- Introduction
- General Specifications
- LCD Specifications
- Dimensions

---

## 1.1 Introduction

The PPC-L128T panel PC is an Intel low-power Intel® Atom™ N270 processor computer that is designed to serve as a human machine interface (HMI) and as a multimedia computer. It is a PC-based system with 12.1" color TFT LCD display, on-board PCIe Ethernet controller, multi-COM port interfaces and an audio controller. With a built in internal IDE connector (for CF card), One SATA connector for HDD and one for ODD, and an PCI/PCIe expansion socket, the PPC-L128T is as compact and user friendly as a multifunction computer. In addition, its "fit anywhere" design makes it very flexible and able to be used in many different kinds of installations. It can be wall mounted, panel mounted or stood upright on a desktop.

For system integrators, this simple, complete, compact and highly integrated multimedia system lets you easily build a panel PC into your applications. Common industrial applications include factory automation systems, precision machinery, and production process control. It is also suitable for many nonindustrial applications, including interactive kiosk systems, entertainment management, and car park automation. Our panel PC is a reliable, cost-effective solution to your application's processing requirements.

## 1.2 General Specifications

### 1.2.1 General

- **Dimensions (W x H x D):** 340.5 x 269.3 x 70.5 mm
- **Weight:** 3.63 kg
  - Power supply: ATX type
  - Input Voltage: +12 ~ 24 VDC, 5 A ~ 3.75 A
  - Power adaptor: AC/DC (Optional PS-DC19-L157E ) Input voltage: 100 ~ 240 VAC
  - Output voltage: 19 V @ 4.74 A
- **Disk drive housing:** Space for one 2.5" SATA HDD, one slim type DVD-RW
- **Front panel:** IP65/NEMA4 compliant

### 1.2.2 Standard PC functions

- **CPU:** On board Intel® Atom™ N270, 1.6 GHz with 512 L2 cache
- **BIOS:** Award 8 Mbit flash BIOS, ACPI 2.0 Compliant
- **System Chipset:** Intel® 945GSE + Intel ICH7M
- **Front side bus:** 533 MHz
- **2nd level cache:** 512 KB
- **System Memory:** One 200-pin SO-DIMM socket, accepting up to 2 GB DDR2 400/ 533
- **PCI bus interface:** PCI 33MHz/32Bit Supports one connectors.
- **Keyboard/mouse connector:** Supports PS/2 Keyboard and Mouse
- **GPIO port:** One GPIO port supports controller and surveillance function.
- **Serial ports:** Three serial ports with two RS-232 ports (COM 1 and 3), one RS-232/422/485 port (COM2). All ports are compatible with 16C550 UARTs, +5 V (0.5 A) / +12 V (0.5 A) power supply selectable
- **Universal serial bus (USB) port:** Support Up to 6 USB V2.0 ( 4 x external, 2 x internal.
- **PCIe bus expansion slot:** Accepts one PCIe card

- **Mini PCIe bus expansion slot:** Accepts one mini PCIe bus card(Wire less LAN card)
- **Solid State Disk:** Supports one 50-pin socket for CompactFlash type I/II (True IDE mode)
- **Watchdog timer:** 255-level timer intervals, from 15 sec to 14835 sec, setup by software, jumperless selection, generates system reset
- **Battery:** 3.0 V @ 195 mA lithium battery
- **Power management:** Supports power saving modes including S0:Normal/S1:Standby/S3:Suspend modes. APM 1.2 compliant

### 1.2.3 VGA/LCD Interface

- **Chipset:** Integrated in Intel 945GSE
- **Frame buffer:** Supports 128MB frame buffer with system memory
- **Interface:** VGA/ LCD interface, support for 18-bit TFT
- **Display mode:** CRT Modes: 2048 x 1536 @ 32bpp (60Hz);  
**LCD/Simultaneous Modes:** 1024 x768 @ 16bpp (60 Hz)

### 1.2.4 Audio function

- **Chipset:** Intel ICH7M South Bridge
- **Audio controller:** PPC-L128T-R80 series: ALC888; PPC-L128T-R81 series: ALC89. HD Audio Ver 2.0 compliant interface, Multi- stream Direct sound and Direct Sound 3D acceleration
- **Stereo sound:** 24-bit full-duplex codec
- **Audio interface:** Microphone in, Line in, Line out, Speaker L, Speaker R

### 1.2.5 PCIe bus Ethernet interface

- **Chipset:** PPC-L128T-R80 series: Marverll 88E8053-A3-NNC1C000; PPC-L128T-R81 series: REALTEK RTL8111D-GR. PCIe local bus Ethernet controller
- **Ethernet interface:** Full compliance with IEEE 802.3, 1000Base-T 100Base-T and 10 Base-T specifications.Support 802.1p, 802.1q. Includes software drivers and boot ROM
- **1000/100/10Base-T auto-sensing capability**
- **Wake-on-LAN:** Supports Wake-on-LAN function with ATX power control
- **Teaming Function:** Support Teaming Function(refer to A.10)

### 1.2.6 Touchscreen (Optional)

	PPC-L128T-R80 Series	PPC-L128T-R81 Series
Type	Analog Resistive	Analog Resistive
Resolution	Continuous	Continuous
Light Transmission	80%	80%
Controller	USB interface	COM interface
Power Consumption	<5 V @ 60 mA	<5.5 V @ 70 mA
Software Driver	Supports Windows 2000/XP /Vista	Supports Windows 2000/XP/ Vista
Durability (touches in a lifetime)	35 million	36 million

## 1.2.7 Optional modules

- **Memory:** One 200-pin SO-DIMM socket, accepting up to 2 GB DDR2 400/533
- **DVD-RW Module:** Slim type DVD-RW Module 989KL128T00E
- **Combo Module:** Slim type Combo Module 989KL128T01E
- **Wireless LAN module:** 989KL128T02E (Build in IEEE 802.11b/g AzureWave AW-NE768 Mi MINI PCIe card)
- **Adaptor:** PS-DC19-L157E
- **HDD:** 2.5" SATA HDD
- **Operating System:** Windows XP,Vista
- **Touchscreen:** Analog resistive
- **Battery pack:** Rechargeable Li-ion 3S2P 11.1 V 4400 mAh(1760000837)

## 1.2.8 Environment

- **Operating Temperature:** 0 ~ 45° C (32 ~ 113° F)
- **Operating Temperature with battery:** 0 ~ 35° C (32 ~ 95° F)
- **Storage Temperature:** -20 ~ 60° C
- **Relative humidity:** 10 ~ 95% @ 40° C (non-condensing)
- **Shock:** 10 G peak acceleration (11 ms duration)
- **Certification:** EMC: CE, FCC, BSMI, VCCI. Safety: UL 60950, CB, CCC, BSMI
- **Vibration:** 5 ~ 500 Hz 1 G RMS Random vibration

## 1.3 LCD Specifications

### 1.3.1 PPC-L128T-R80 series

- **Display type:** 12.1" TFT LCD
- **Max. resolution:** 1024 x 768
- **Colors:** 262 K
- **Dot size (mm):** 0.24 x 0.24
- **Viewing angle:** 80° (left), 80° (right), 80° (up), 80° (down)
- **Luminance:** 450 cd/m<sup>2</sup>
- **Temperature:** -30 ~ 70° C
- **Backlight lifetime:** 50,000 hours

### 1.3.2 PPC-L128T-R81 Series

- **Display type:** 12.1" TFT LCD
- **Max. resolution:** 1024 x 768
- **Colors:** 262 K/16.2M
- **Dot size (mm):** 0.24 x 0.24
- **Viewing angle:** 70° (left), 70° (right), 80° (up), 80° (down)
- **Luminance:** 600 cd/m<sup>2</sup>
- **Temperature:** -30 ~ 80° C
- **\*VR control:** Brightness could be modified through BIOS
- **Backlight lifetime:** 50,000 hours

**Note!**  The color LCD display installed in the panel PC is high-quality and reliable. However, it may contain a few defective pixels which do not always illuminate. With current technology, it is impossible to completely eliminate defective pixels. Advantech is actively working to improve this technology.

## 1.4 Dimensions

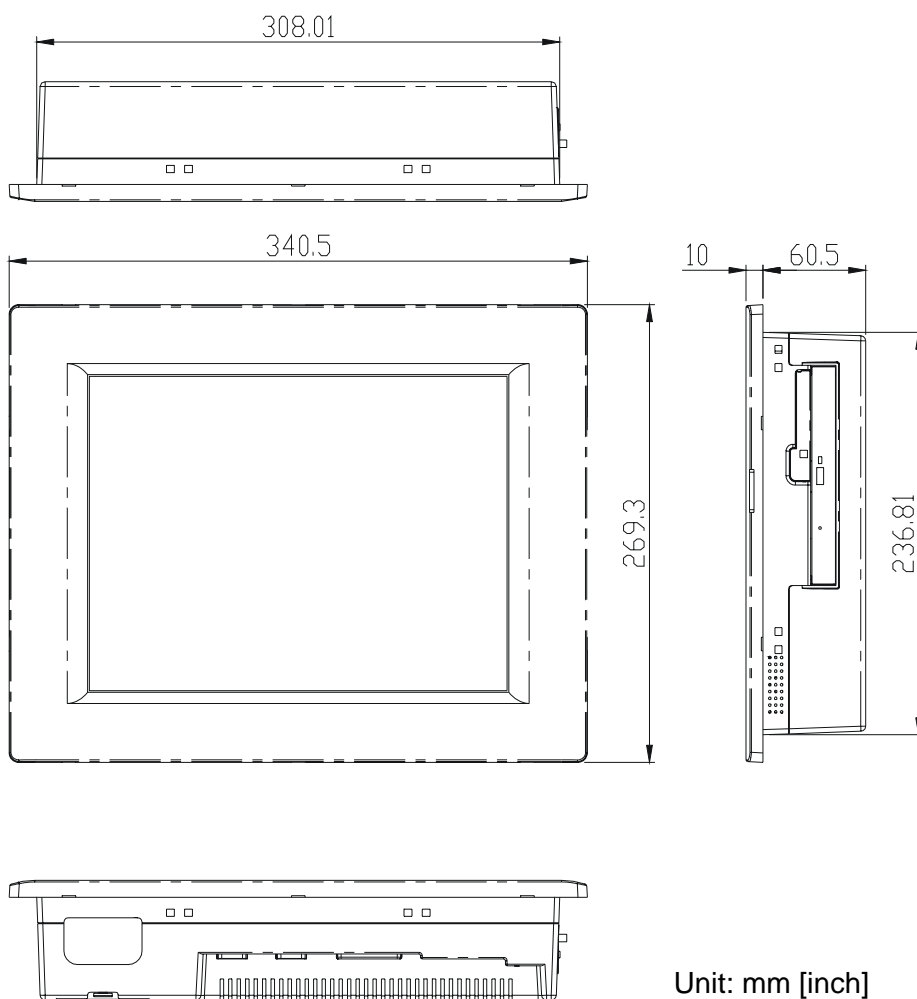

**Figure 1.1 Dimensions of PPC-L128T**



# Chapter 2

## System Setup

This chapter details system setup on the PPC-L128T panel PC.

Sections include:

- A Quick Tour of the Panel PC
- Installation procedures
- Running the BIOS Setup Program
- Installing System Software
- Installing the Drivers

## 2.1 A Quick Tour of the Panel PC

Before you start to set up the panel PC, take a moment to become familiar with the locations and purposes of the controls, drives, connectors and ports, which are illustrated in the figures below.

When you place the panel PC upright on the desktop, its front panel appears as shown in Figure 2.1.



Figure 2.1 Front view of PPC-L128T panel PC

When you turn the panel PC around and look at its rear cover, you will find the I/O section as shown in Fig. 2.2. (The I/O section includes various I/O ports, including serial ports, the Ethernet port, USB ports, the Line-in/Line-out jack, and so on.) The battery door cover is at the bottom of the panel PC, as shown in Fig. 2.4.

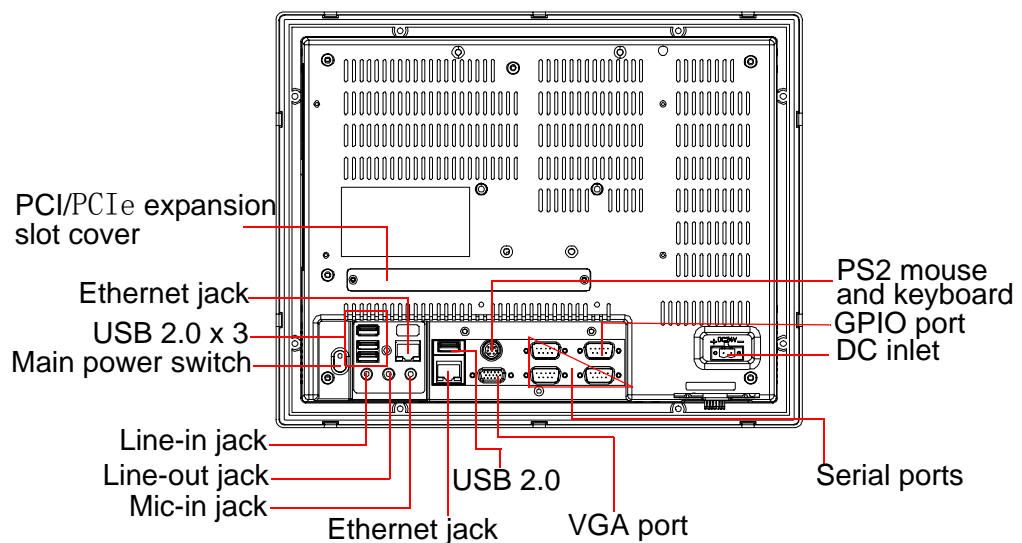

Figure 2.2 Rear view of Panel PC



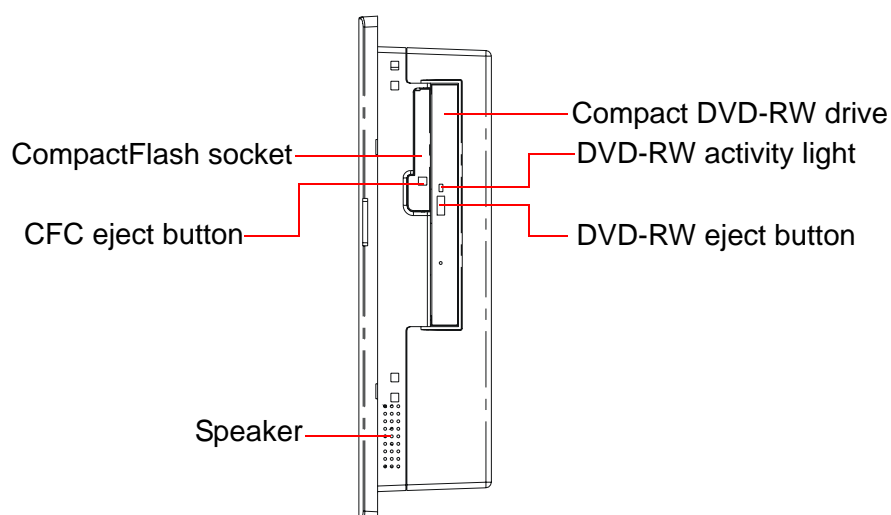

Figure 2.3 Side view of the panel PC

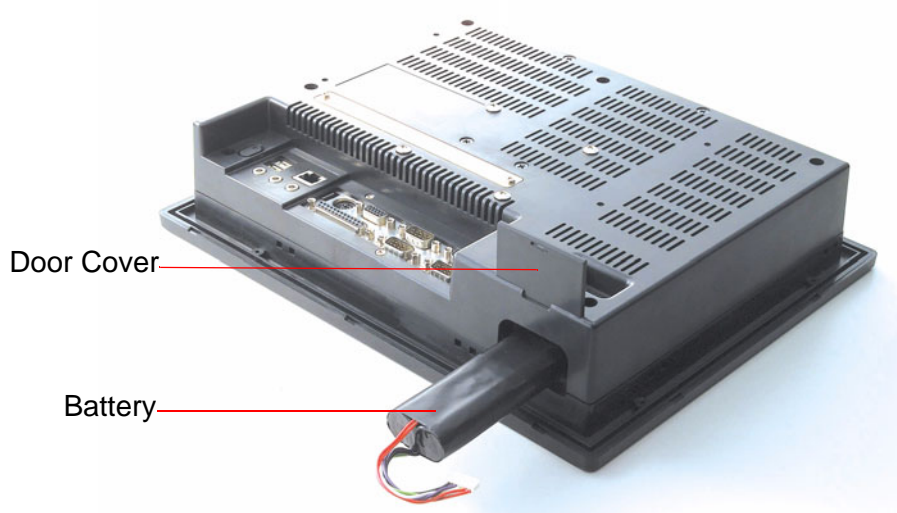

Figure 2.4 Bottom view of the panel PC

## 2.2 Installation Procedures

### 2.2.1 Connecting the power cord

The panel PC can be powered by a DC electrical outlet or the battery. Be sure to always handle the power cords by holding the plug ends only. Please follow the Figure 2-5 to connect the male plug of the power cord to the DC inlet of the panel PC.

### 2.2.2 Connecting the keyboard or mouse

Before you start the computer, please connect the Y-shaped adaptor to the PS/2 mouse and keyboard port on the I/O section of the panel PC, then connect the necessary mouse or keyboard to the Y-shaped adaptor or serial ports.

### 2.2.3 Switching on the power

When you look at the rear side of the panel PC, you will see the power switch as shown in Figure 2.2.

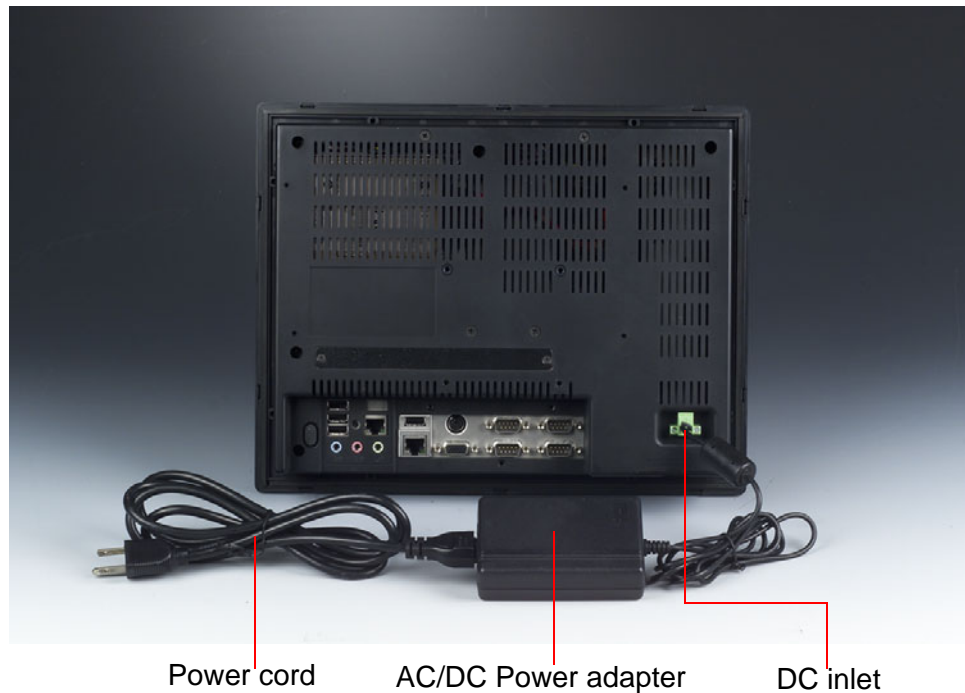

**Figure 2.5 Connect the power cord to the DC inlet**

## 2.3 Running the BIOS Setup Program

Your panel PC is likely to have been properly set up and configured by your dealer prior to delivery. You may still find it necessary to use the panel PC's BIOS (Basic Input-Output System) setup program to change system configuration information, such as the current date and time or

your type of hard drive. The setup program is stored in read-only memory (ROM). It can be accessed either when you turn on or reset the panel PC, by pressing the 'Del' key on your keyboard immediately after powering on the computer.

The settings you specify with the setup program are recorded in a special area of memory called CMOS RAM. This memory is backed up by a battery so that it will not be erased when you turn off or reset the system. Whenever you turn on the power, the system reads the settings stored in CMOS RAM and compares them to the equipment check conducted during the power on self-test (POST). If an error occurs, an error message will be displayed on screen, and you will be prompted to run the setup program.

If you want to change the setup of BIOS, refer to Chapter 9 for more detailed information.

## 2.4 Installing System Software

Recent releases of operating systems from major vendors include setup programs which load automatically and guide you through hard disk preparation and operating system installation. The guidelines below will help you determine the steps necessary to install your operating system on the panel PC hard drive.

**Note!** *Some distributors and system integrators may have already pre-installed system software prior to shipment of your panel PC.*



Installing software requires an installed HDD. Software can be loaded in the PPC-L128T using any of four methods:

### 2.4.1 Method 1: Use the Ethernet

You can use the Ethernet port to download software to the HDD.

### 2.4.2 Method 2: Use the COM

You can use Lap Link 6 or similar transmission software. Connect another PC to the PPC-L128T with an appropriate cable and transmit the software to the PPC-L128T.

### 2.4.3 Method 3: Use a DVD-RW

If required, insert your operating system's installation or setup diskette into the diskette drive until the release button pops out.

The BIOS of the panel PC supports system boot-up directly from the DVD-RW drive. You may also insert your system installation DVD-RW into the DVD-RW drive.

Power on your panel PC or reset the system by pressing the 'Ctrl+Alt+Del' keys simultaneously. The panel PC will automatically load the operating system from the diskette or DVD-RW.

If you are presented with the opening screen of a setup or installation program, follow the instructions on screen. The setup program will guide you through preparation of your hard drive, and installation of the operating system. If you are presented with an operating system command prompt, such as A:\>, then you must partition and format your hard drive, and manually copy the operating system files to it. Refer to your operating system user manual for instructions on partitioning and formatting a hard drive.

## 2.5 Installing the Drivers

After installing your system software, you will be able to set up the Ethernet, SVGA, audio, and touchscreen functions. All drivers are stored in a DVD-RW disc entitled "Drivers and Utilities" which can be found in your accessory box.

The various drivers and utilities in the DVD-RW disc have their own text files which help users install the drivers and understand their functions. These files are a very useful supplement to the information in this manual.

**Note!** *The drivers and utilities used for the PPC-L128T panel PCs are subject to change without notice. If in doubt, check Advantech's website or contact our application engineers for the latest information regarding drivers and utilities.*





# Chapter 3

## Hardware Installation and Upgrading

This chapter details installing the PPC- L128T panel PC hardware.

Sections include:

- Overview of Hardware Installation and Upgrading
- Installing the 2.5" Hard Disk Drive (HDD)
- Installing the battery pack

## 3.1 Introduction

The panel PC consists of a PC-based computer that is housed in a plastic rear panel and a metal shielding case. You can install a HDD, DRAM, and battery pack by removing the rear panel and shielding case. Any maintenance or hardware upgrades can be easily completed after removing the rear panel and shielding case.

If you are a systems integrator and need to know how to completely disassemble the panel PC, you can find more useful information in Appendix C.

**Warning!** Do not remove the plastic rear cover until you have verified that no power is flowing within the panel PC. Power must be switched off and the power cord must be unplugged. Every time you service the panel PC, you should be aware of this.



## 3.2 Installing the 2.5" Hard Disk Drive (HDD)

You can attach one Serial Advanced Technology Attachment (SATA) hard disk drive to the panel PC's internal controller. The SATA controller supports faster data transfer and allows the SATA hard drive to exceed 150 MB. The following are instructions for installation:

1. Detach and remove the plastic rear cover.
2. There is a metal brace which holds the HDD to the upper left-hand side of the metal shielding case. (See Fig. 3.1.)
3. Place the HDD in the metal brace, and tighten the screws.
4. The HDD cable (SATA 7P+1\*5P-2.5/SATA(15+7)P) is next to the metal brace. Connect the HDD cable to the PC board (CN5&CN6). Plug the other end of the cable into the SATA hard drive.
5. Put the plastic rear cover on and tighten the screws.

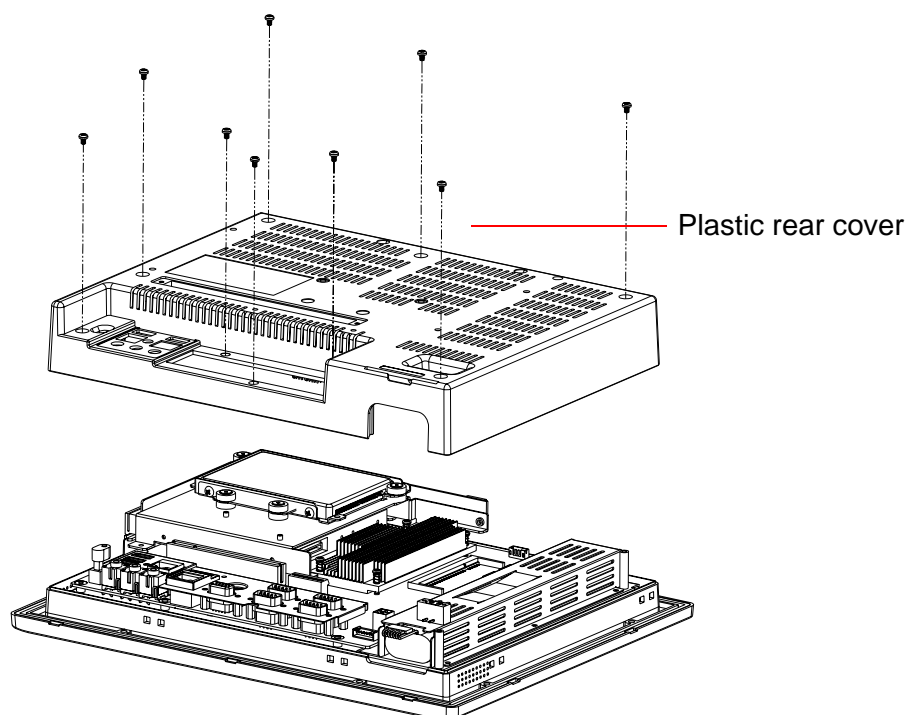

Figure 3.1 Installing primary 2.5" HDD

### 3.3 Installing the battery pack

1. Pull up the battery door cover on the right bottom of PPC-L128T.
2. Put the battery pack in, and then connect the battery cable to battery connector in the PPC-L128T. Make sure the red wire corresponds to Pin 1 on the connector.
3. Close the battery door cover.

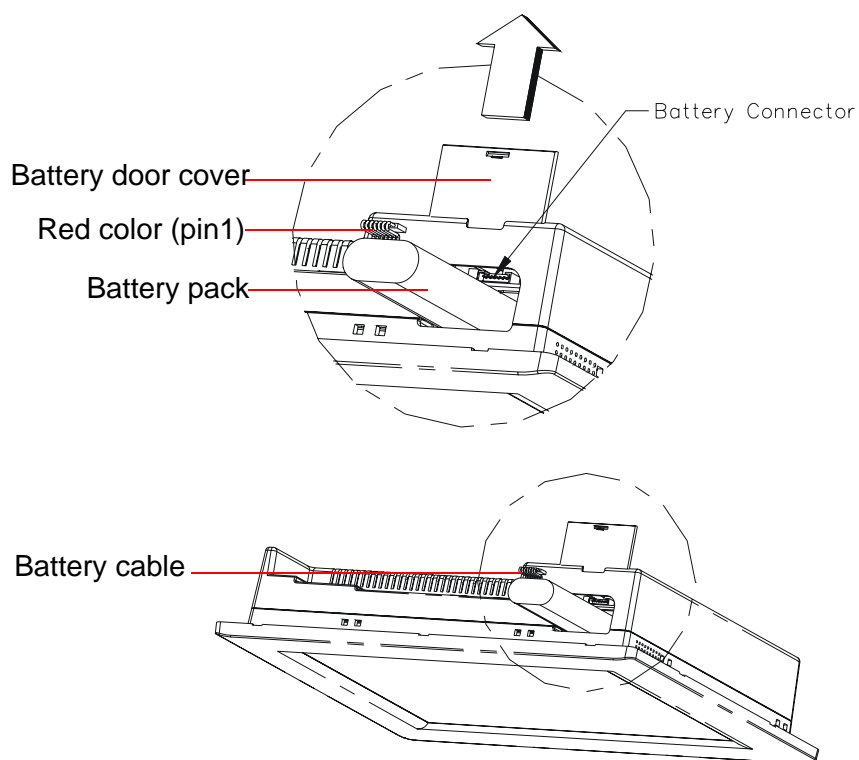

Figure 3.2 Installing the battery pack





# Chapter 4

## Jumper Settings and Connectors

This chapter tells how to set up the panel PC hardware, including instructions on setting jumpers and connecting peripherals, switches and indicators. Be sure to read all the safety precautions before you begin the installation procedures.

Sections include:

- Jumpers and Connectors
- CMOS Clear for External RTC (J5)
- COM Port Interface
- VGA Interface
- Watchdog Timer Configuration

## 4.1 Jumpers and Connectors

### 4.1.1 Setting jumpers

You can configure your panel PC to match the needs of your application by setting jumpers. A jumper is the simplest kind of electrical switch. It consists of two metal pins and a small metal clip (often protected by a plastic cover) that slides over the pins to connect them. To “close” a jumper, you connect the pins with the clip. To “open” a jumper you remove the clip. Sometimes a jumper will have three pins, labeled 1, 2 and 3. In this case, you would connect either pins 1 and 2 or pins 2 and 3.

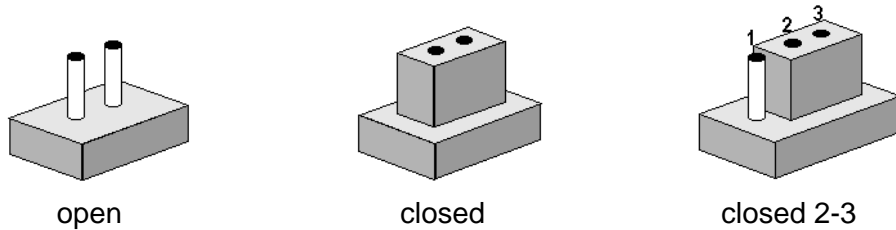

The jumper settings are schematically depicted in this manual as follows:.

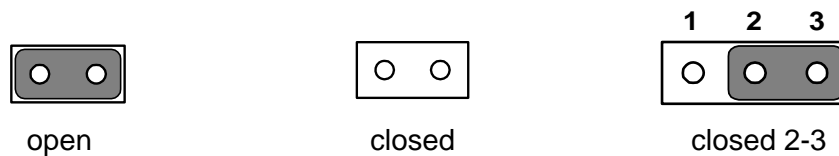

A pair of needle-nose pliers may be helpful when working with jumpers.

If you have any doubts about the best hardware configuration for your application, contact your local distributor or sales representative before you make any changes.

## 4.1.2 Jumpers and connectors

The motherboard of the PPC-L128T has a number of jumpers and connectors that allow you to configure your system to suit your applications. The table below lists the function of each of the board's jumpers.

**Table 4.1: Jumpers and Connector functions**

CN1	LVDS connector
CN3	Inverter power connector
CN4	CF Slot ,TYPEII
CN5	SATA HDD signal connector (2.5" HDD)
CN6	SATA HDD power connector (2.5" HDD)
CN7	DDR2 SO-DIMM
CN8	MINI PCIe slot
CN9	5 Wires T/S connector
CN11	SATA ODD signal connector
CN12	SATA ODD power connector
CN16	PCIe (x1) slot
CN18	PCI bus expansion slot
CN19	Internal USB connector
CN23	Internal Speaker connector
CN33	Internal power connector
CN40	LCD light sensor connector
CN41	Front panel connector
PCN1	Battery connector
CN13	Clear CMOS connector
CN14	AT/ATX selection connector
CN20	COM1/2 Pin9 function selection
CN21	COM3 Pin9 function selection

### 4.1.3 Locating jumpers and connectors

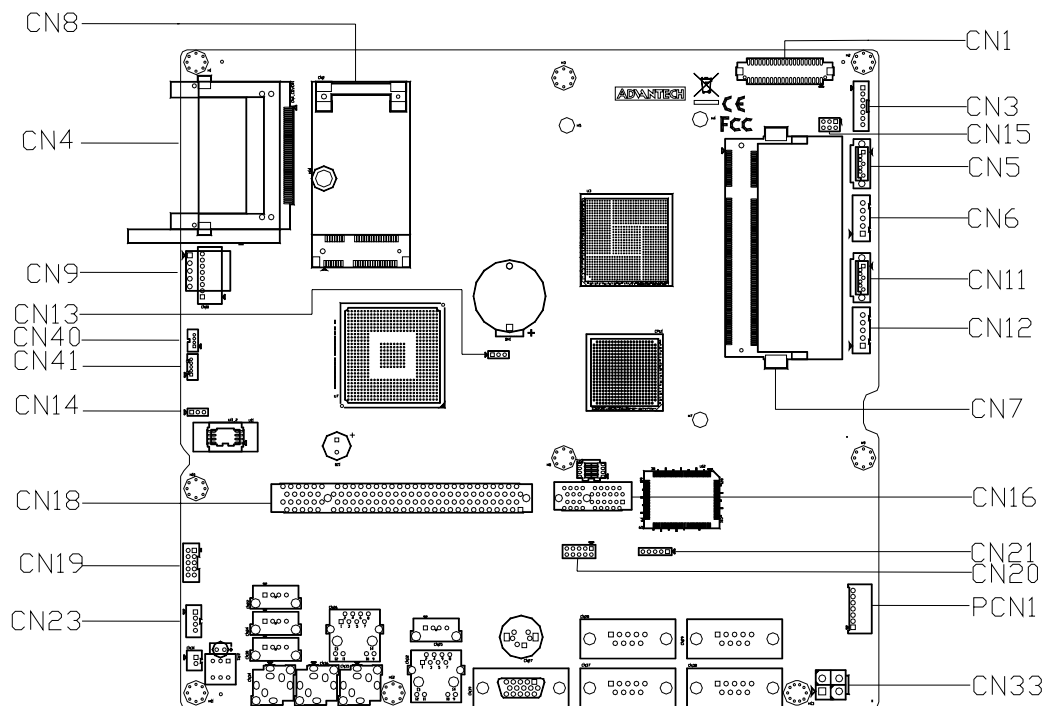

Figure 4.1 Jumpers and Connectors on the PPC-L128T motherboard

## 4.2 CMOS Clear for External RTC (CN13(2-3))

**Warning!** To avoid damaging the computer, always turn off the power supply before setting "Clear CMOS". Set the jumper back to "Normal operation" before turning on the power supply.



This jumper is used to erase CMOS data and reset system BIOS information. The procedure for clearing CMOS is:

1. Turn off system.
2. Short pin 2 and pin 3.
3. Return jumper to pins 1 and 2.
4. Turn on the system. The BIOS is now reset to its default setting.

Table 4.2: CMOS clear (CN13)

* Normal operation	Clear CMOS
--------------------	------------

\* Default normal operation setting

## 4.2.1 COM1/COM2/COM3 pin 9 output setting (CN20&CN21)

**Table 4.3: COM1/ COM2 pin 9 output setting (CN20)**

CN20

Default Ring function

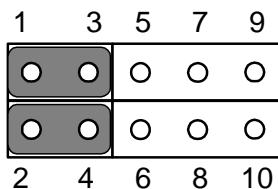

\* +5V output

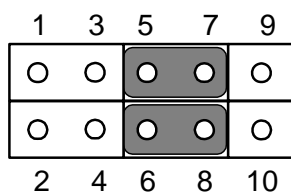

\* +12V output

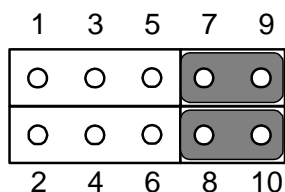

**Note!** Pins 1, 3, 5, 7 and 9 are dedicated to COM1.



Pins 2, 4, 6, 8 and 10 are dedicated to COM2.

**Table 4.4: COM3 pin 9 output setting (CN21)**

CN21

Default Ring function

Ring function (1-2)



Output 5 V(3-4)



Output 12 V(4-5)



## 4.3 VGA Interface

### 4.3.1 LCD panel power setting

The panel PC's AGP SVGA interface supports 12V LCD displays. The LCD cable already has a built-in default setting. You do not need to adjust any jumper or switch to select the panel power.



# Appendix **A**

I/O Pin Assignments

## A.1 Keyboard and PS/2 Mouse Connector (CN27)

**Table A.1: Keyboard and mouse connector (CN27)**

Pin	Signal
1	KB_DATA
2	MS-DATA
3	GND
4	+5 V
5	KB_CLK
6	MS-CLK

## A.2 USB port (CN19)

**Table A.2: USB port (CN19)**

Pin	Signal
1	+V5_USB
3	DATA-
5	DATA+
7	GND
9	GND
2	+V5_USB
4	DATA-
6	DATA+
8	GND
10	GND

## A.3 COM1 RS-232 serial port (CN37)

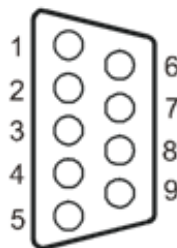
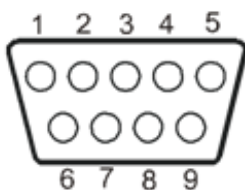

**Table A.3: COM1 RS-232 serial port (CN37)**

Pin	Signal	Pin	Signal
1	DCD#	2	RX
3	TX	4	DTR#
5	GND	6	DSR#
7	RTS#	8	CTS#
9	RI#		



## A.4 COM2 (CN28)



**Table A.4: COM2 (CN28)**

Pin	Signal RS-232	RS-422	RS-485
1	DCD	TX-	DATA-
2	RX	TX+	DATA+
3	TX	RX+	
4	DTR	RX-	
5	GND	GND	
6	DSR		
7	RTS		
8	CTS		
9	RI		

## A.5 COM3 RS-232 serial port (CN38)

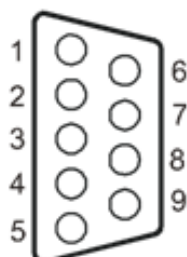

**Table A.5: COM3 RS-232 serial port (CN38)**

Pin	Signal	Pin	Signal
1	DCD#	2	RX
3	TX	4	DTR#
5	GND	6	DSR#
7	RTS#	8	CTS#
9	RI#		

## A.6 GPIO port (CN29)

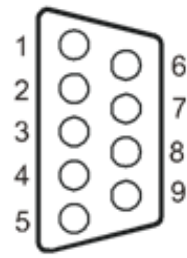

**Table A.6: GPIO port (CN29)**

1	GPIO0	2	GPIO1
3	GPIO2	4	GPIO3
5	GND	6	GPIO4
7	GPIO5	8	GPIO6
9	GPIO7		

## A.7 VGA Connector (CN39)

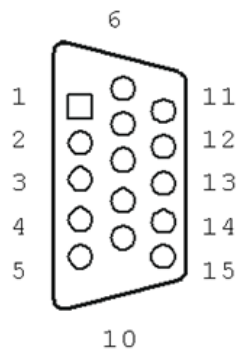

**Table A.7: VGA connector (CN39)**

Pin	Signal
1	RED
2	GREEN
3	BLUE
4	N/A
5	GND
6	GND
7	GND
8	GND
9	N/A
10	GND
11	N/A
12	SPDAT
13	HSYNC
14	VSYNC
15	SPCLK

## A.8 PCI Bus connector (CN18)

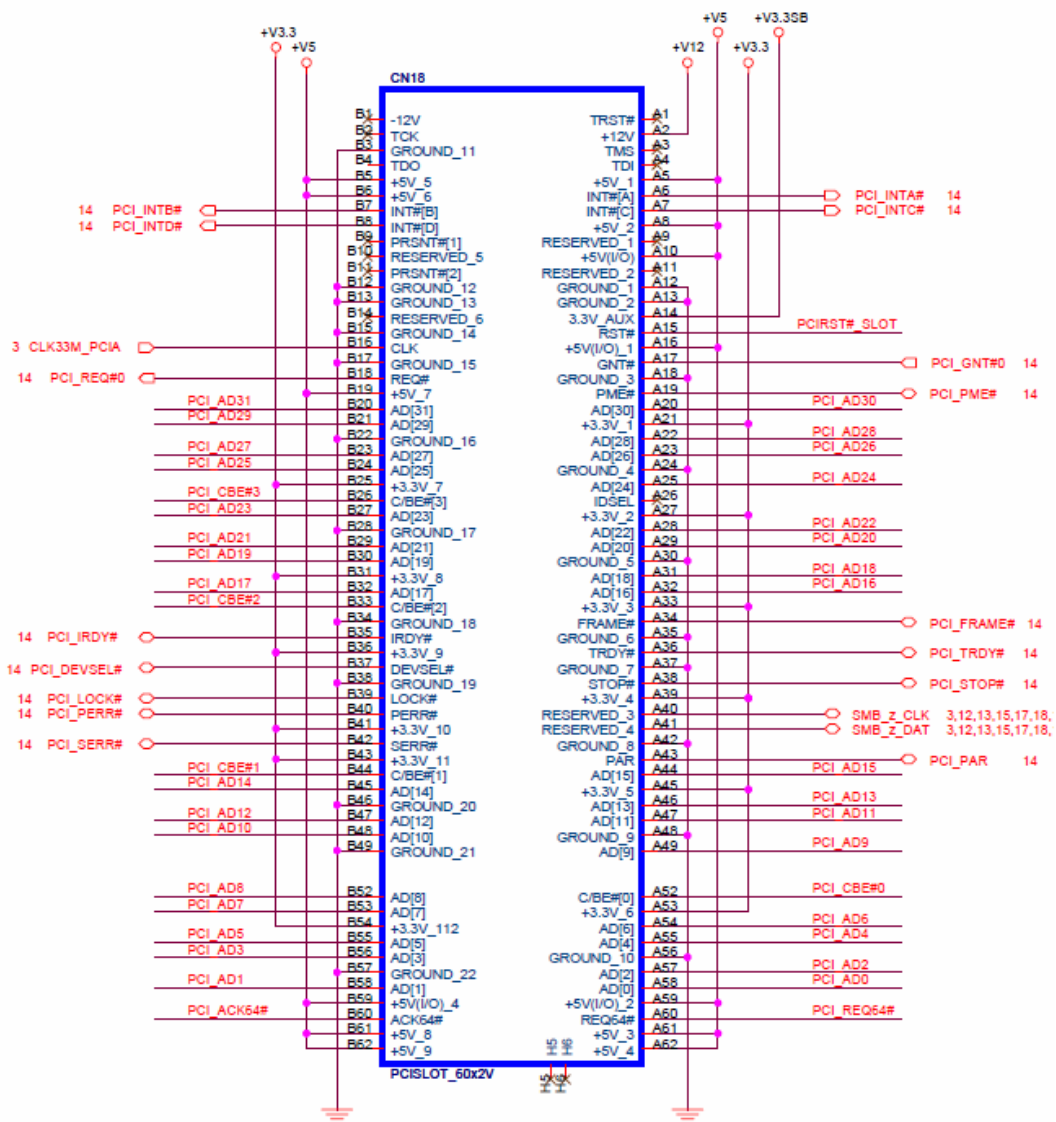
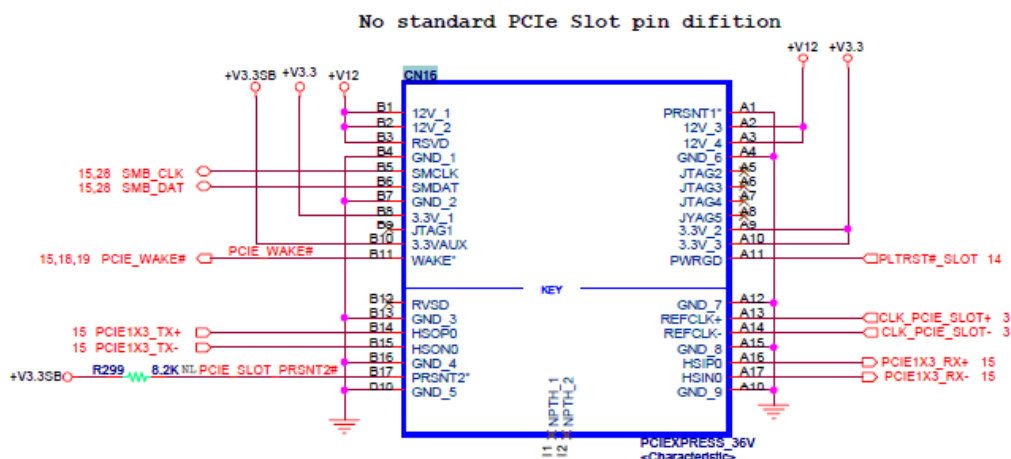

Figure A.1 PCI connector

**Table A.8: PCI pin assignments**

<b>Pin</b>	<b>Signal</b>	<b>Pin</b>	<b>Signal</b>
A1	IOCHK	B1	GND
A2	SD7	B2	RST
A3	SD6	B3	VCC
A4	SD5	B4	IRQ9
A5	SD4	B5	-5 V
A6	SD3	B6	DRQ2
A7	SD2	B7	-12 V
A8	SD1	B8	OWS
A9	SD0	B9	+12 V
A10	IORDY	B10	GND
A11	AEN	B11	SMW
A12	SA19	B12	SMR
A13	SA18	B13	IOW
A14	SA17	B14	IOR
A15	SA16	B15	DACK3
A16	SA15	B16	DRQ3
A17	SA14	B17	DACK1
A18	SA13	B18	DRQ1
A19	SA12	B19	RFSH
A20	SA11	B20	SCLK
A21	SA10	B21	IRQ7
A22	SA9	B22	IRQ6
A23	SA8	B23	IRQ5
A24	SA7	B24	IRQ4
A25	SA6	B25	IRQ3
A26	SA5	B26	DACK2
A27	SA4	B27	TC
A28	SA3	B28	ALE
A29	SA2	B29	VCC
A30	SA1	B30	OSC
A31	SA0	B31	GND

## A.9 PCI Express Bus connector (CN16)



**Table A.9: PCIeExpress pin assignments**

Signal	Pin	Pin	Signal
GND	A1	B1	+V12
+V12	A2	B2	+V12
+V12	A3	B3	+V12
GND	A4	B4	GND
NC	A5	B5	SMB_CLK
NC	A6	B6	SMB_DATA
NC	A7	B7	GND
NC	A8	B8	+V3.3
+V3.3	A9	B9	NC
+V3.3	A10	B10	+V3.3SB
PLTRST#	A11	B11	PCIE_WAKE#
GND	A12	B12	NC
CLK_PCIE+	A13	B13	GND
CLK_PCIE-	A14	B14	PCIE_TX+
GND	A15	B15	PCIE_TX-
PCIE_RX+	A16	B16	GND
PCIE_RX-	A17	B17	PRSNT#
GND	A18	B18	GND

## A.10 How to setup Teaming function on PPC-L128T-R80 series

### A.10.1 Team together

Step 1. PPC-L128/L157 supports dual LAN function with each 1Gbps speed.

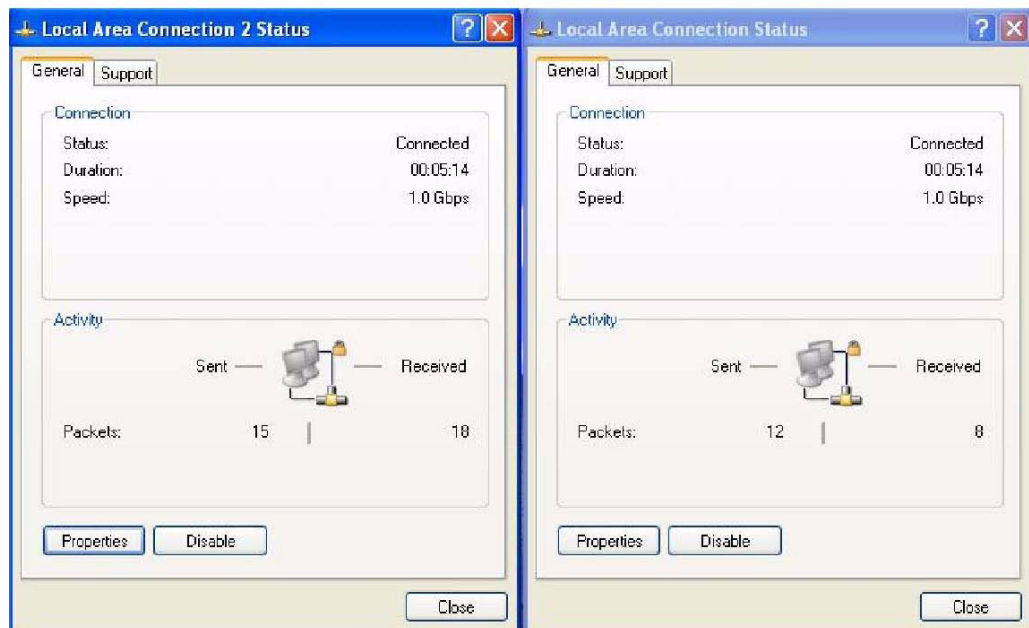

Step 2. First, choose 1 LAN and open the properties panel. Then click on the Configure button.

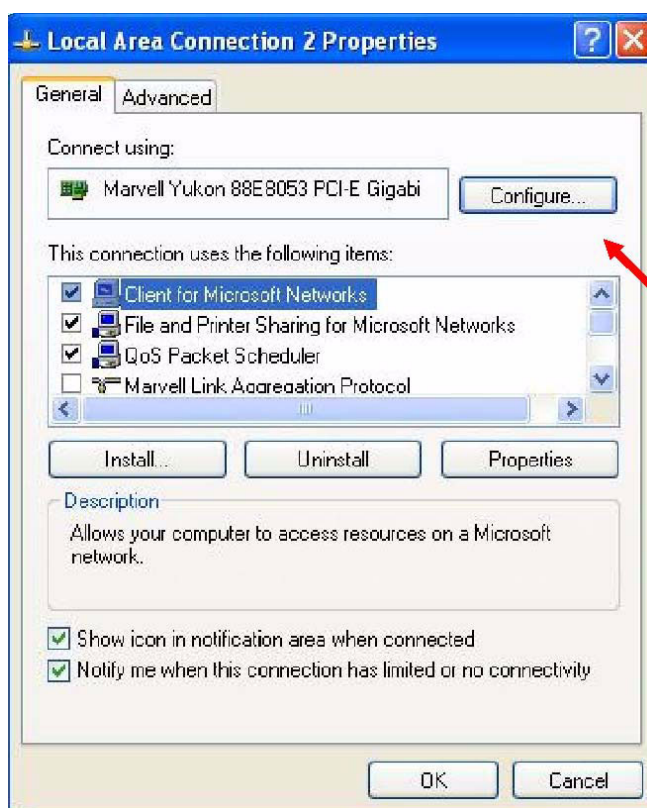

Step 3. Turn to Team page. Here you can create a new team or add to team. Click Create New Team.

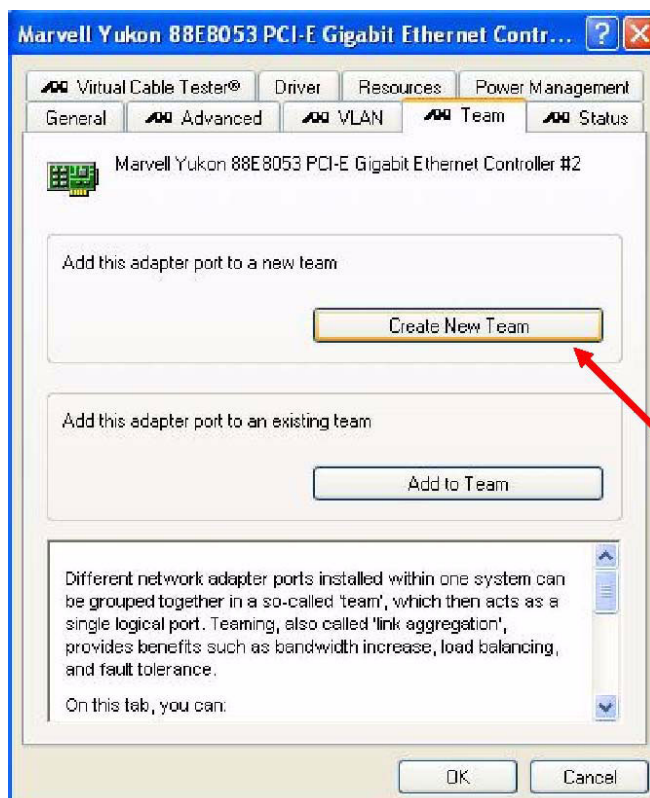

Step 4. Name your team, and select the mode "Basic".

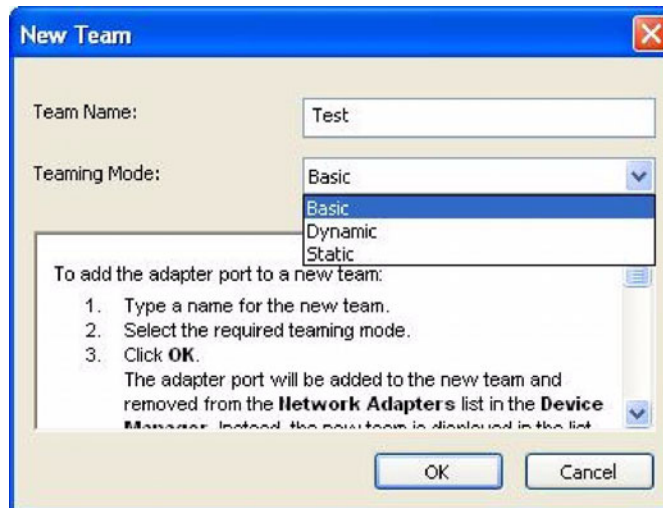

Step 5. Continue anyway.



Step 6. The team has been created.





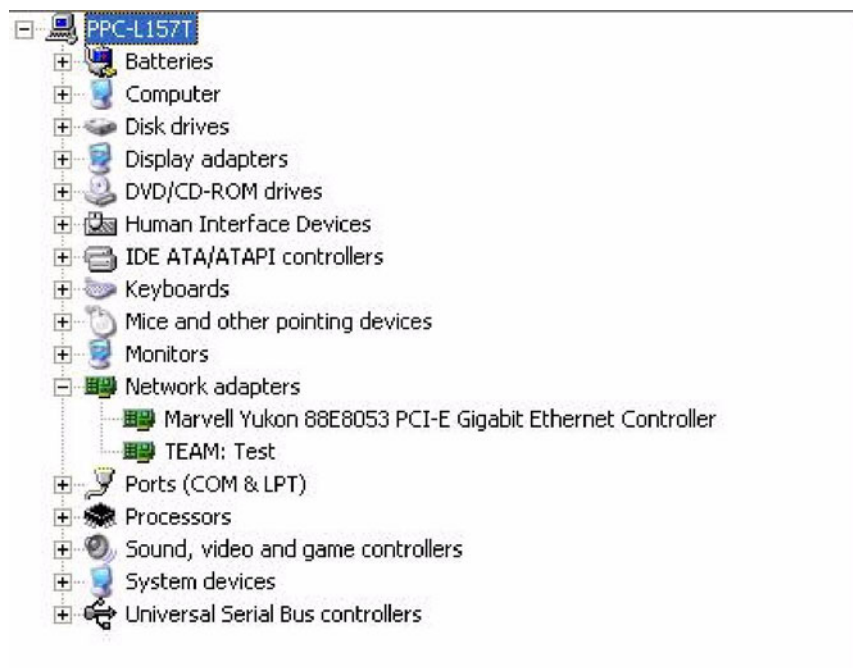

Step 7. Open the properties of another LAN, click “Add to Team” button.

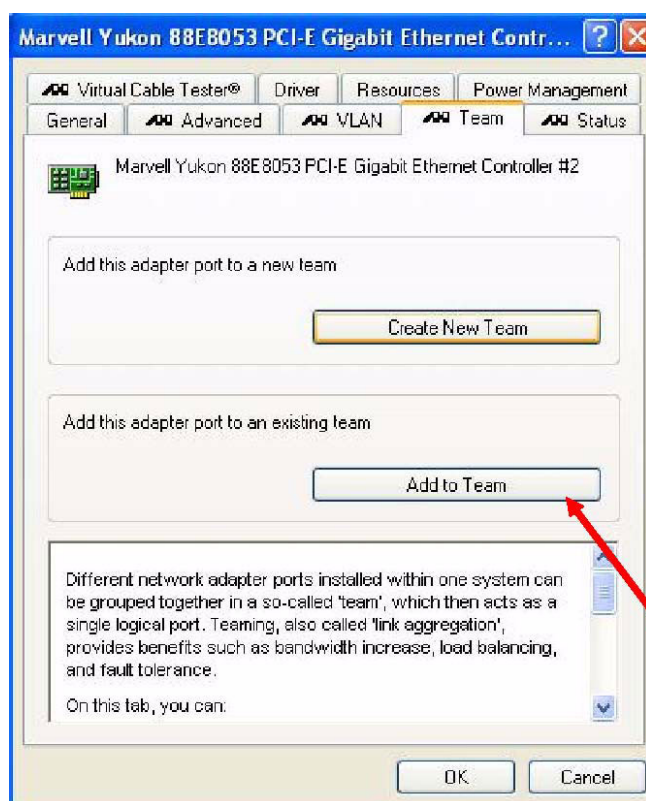

Step 8. Choose the team this LAN should join in.

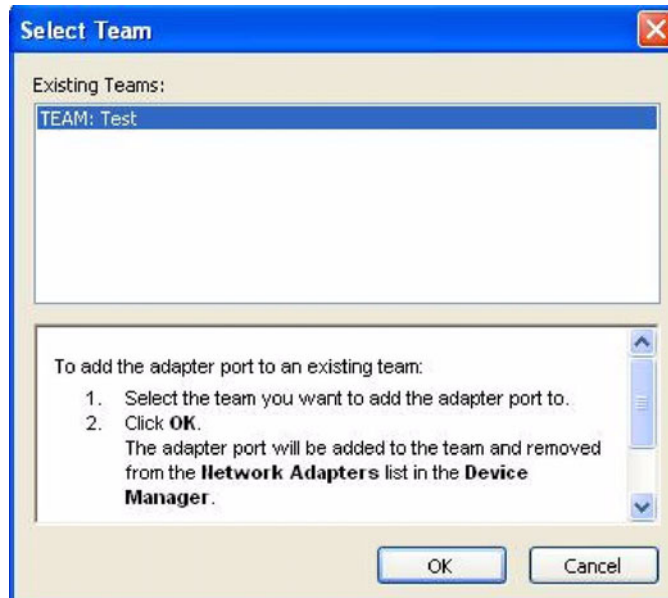

Step 9. Now two LAN become one team with 2Gbps.



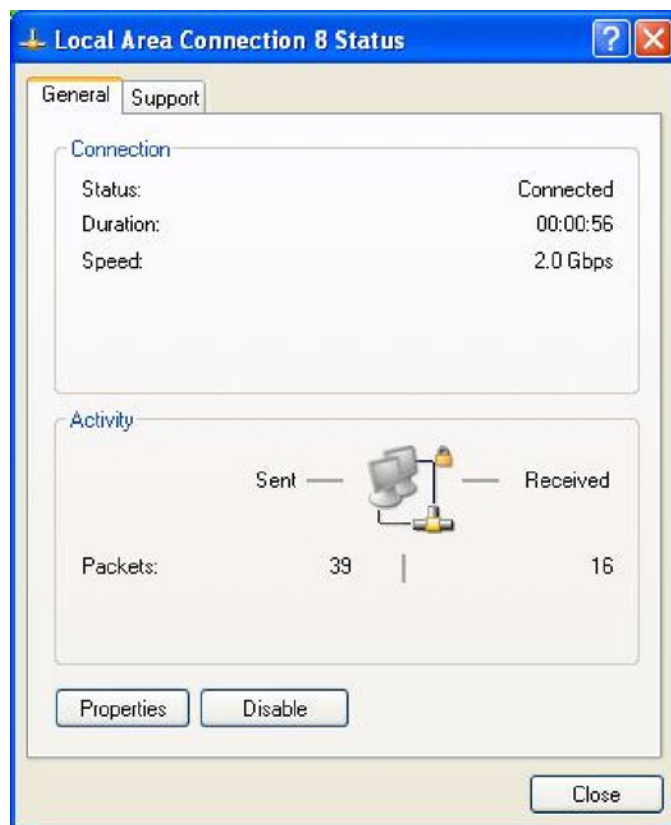

### A.10.2 Dismiss!

Step 1. Open the configure page of teaming LAN. Two team members will show inside.

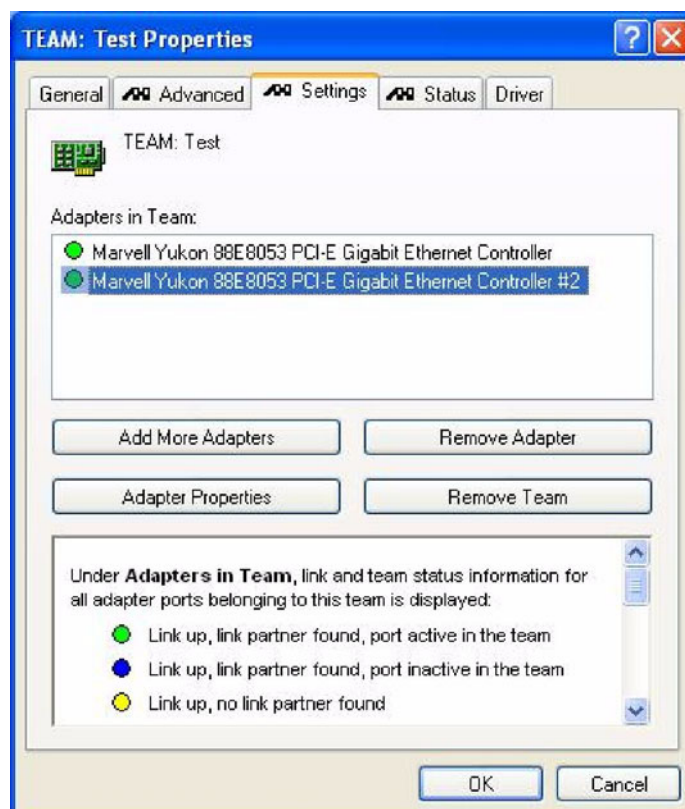

Step 2. Choose the team member you want to kick out. Then click Remove Adapter button.

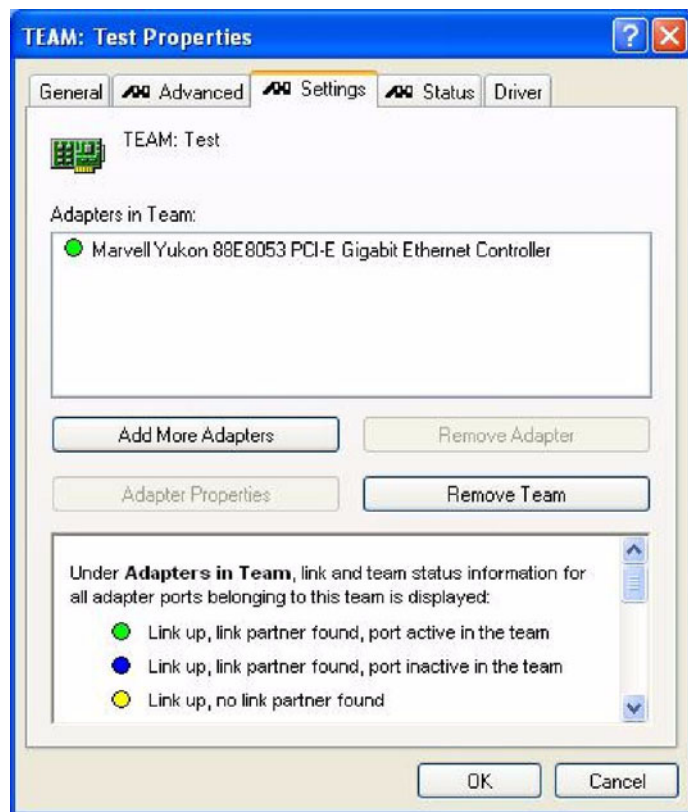

Step 3. If you want to dismiss whole team. Click the Remove Team button and the team will be not available anymore.



### A.10.3 TESTING

Step 1. Copy a big file to your disk through teaming LAN.

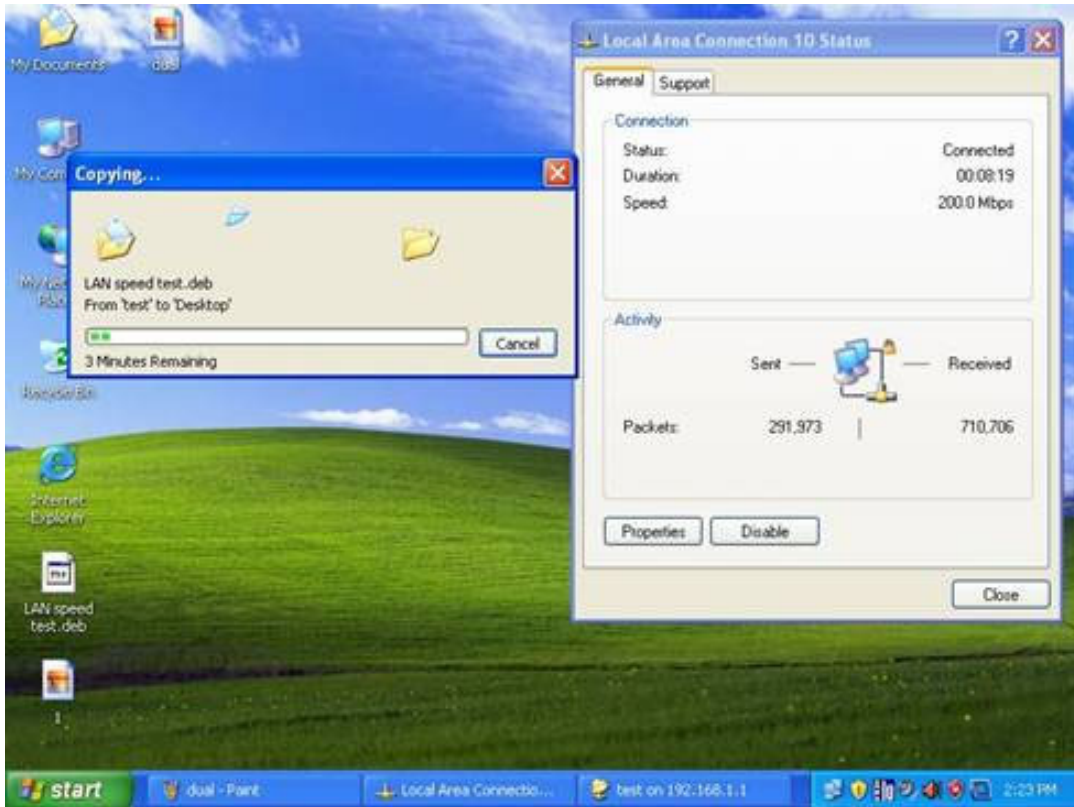

Step 2. Unplug one cable. And the transmission of file still alive. Teaming function works!!

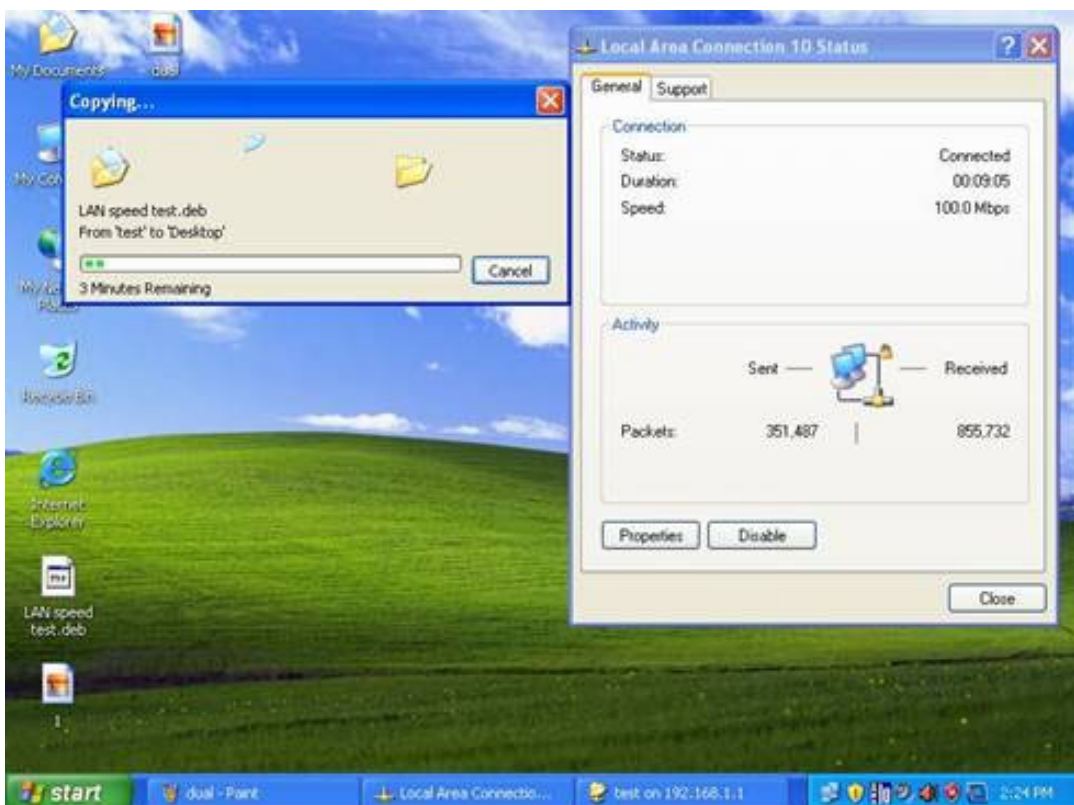

## A.11 How to setup team function on PPC-L128T-R81 series

### A.11.1 Create team function

1. Start the Utility software

From the start up menu, left click the icon in All Programs→Realtek→Diagnostic Utility→Realtek Ethernet Diagnostic Utility, as shown in the figure below:

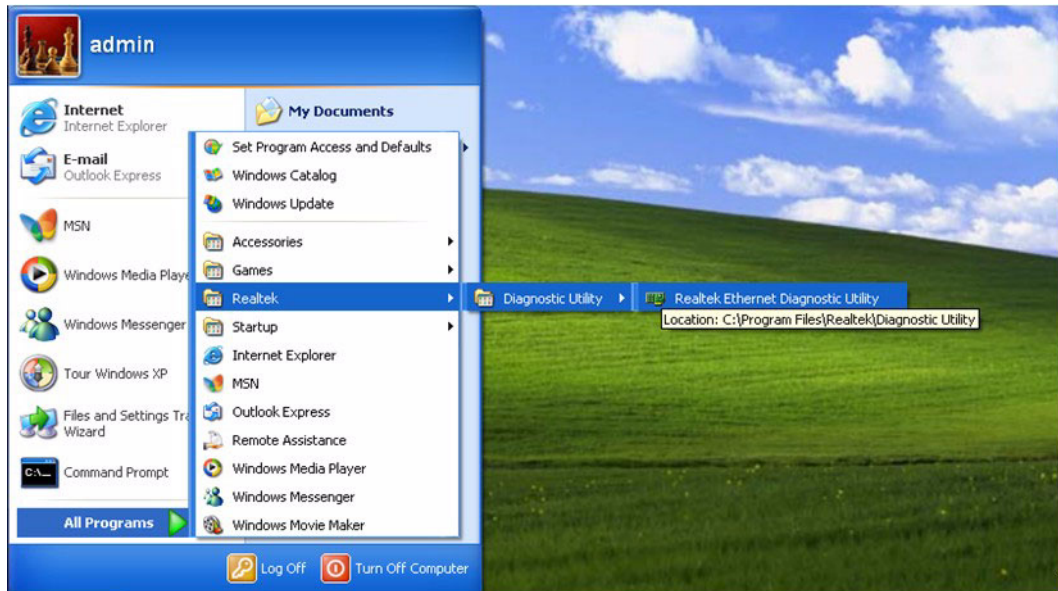

2. Select Adapter and Teaming Function

Select the adapter from the first column. The first column shows all the adapters are on the teaming server. The selected adapter will be the standard. In the following step, we will find the similar adapters form the all network adapters. Select the teaming function from the second column.

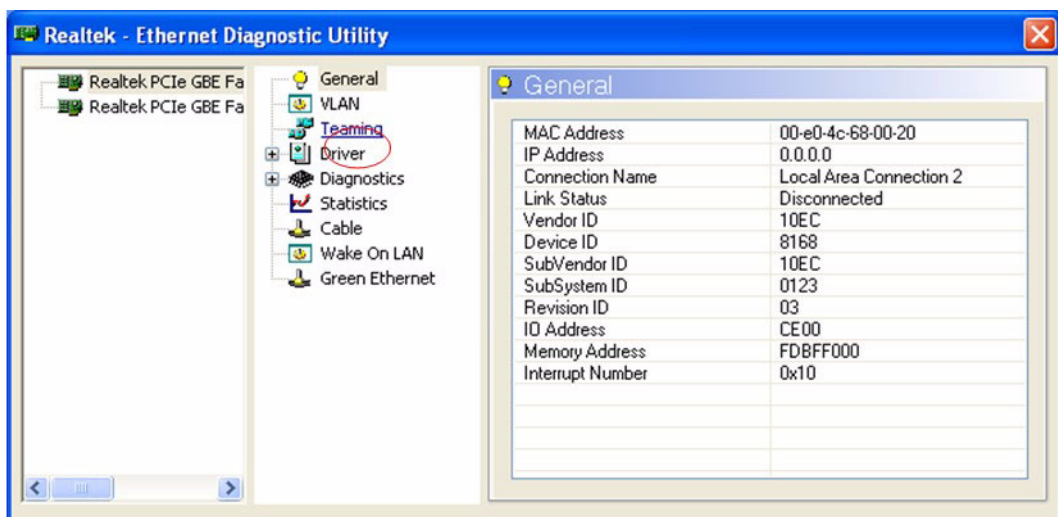

3. Create Teaming Function  
Left click the icon "Create Team" on the third column.

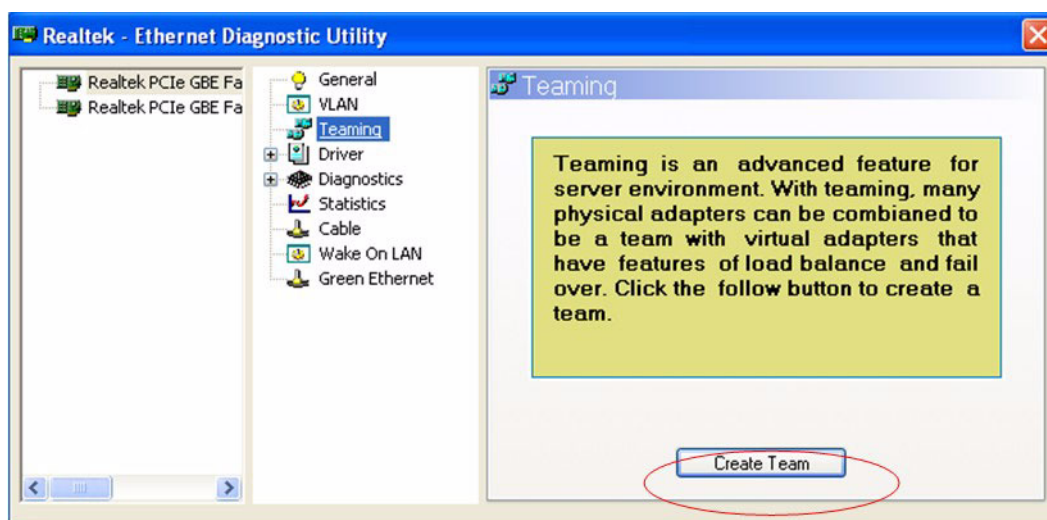

4. Setup Teaming Function  
The teaming includes the Basic Information, Setting, and Add Member Adapters.

#### Basic Info:

The user could type in the team name of the teaming. The teaming name is used for representing the teaming.

#### Settings:

There are three teaming modes for user choice.

##### (1) General Switch Mode

This mode is a round-robin method to decide the packets sent by the adapter. For example, if the teaming contains two adapters. The first adapter sends the packet whose number is odd. The other adapter sends the packet whose number is even.

##### (2) FEC/GEC

The mode needs the switch to support FEC/GEC. So, the switch has to be set up in FEC/GEC mode and which ports are used for teaming.

##### (3) Link Aggregation \ LACP (802.3ad)

The mode needs switch support LACP. LACP is similar to FEC/GEC. But LACP doesn't setup which ports are used for teaming. LACP negotiates the ports with the switch that will make up the team.

#### Add Member Adapters:

The area shows the similar adapters with the selected adapter. The user can choose adapters on the checkbox. These chosen adapters will become teaming members in the next step.

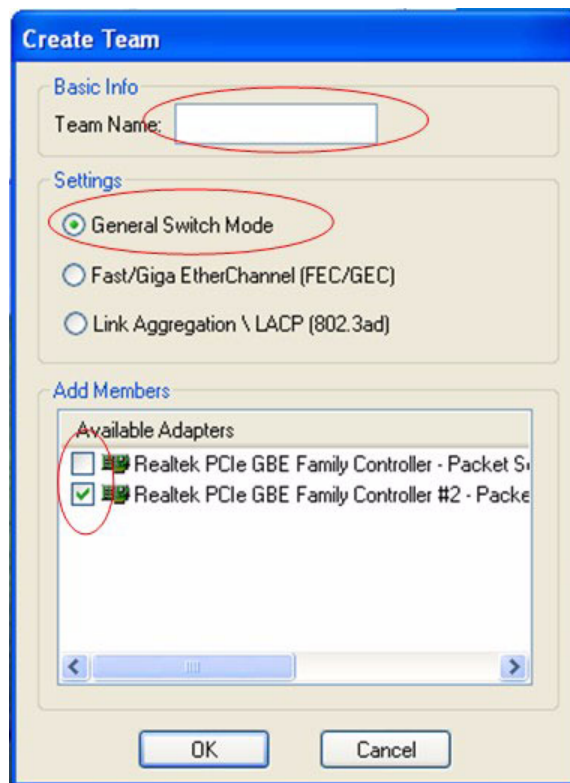

5. Start to Create Teaming Function  
Left click the icon “OK” on the Dialog.

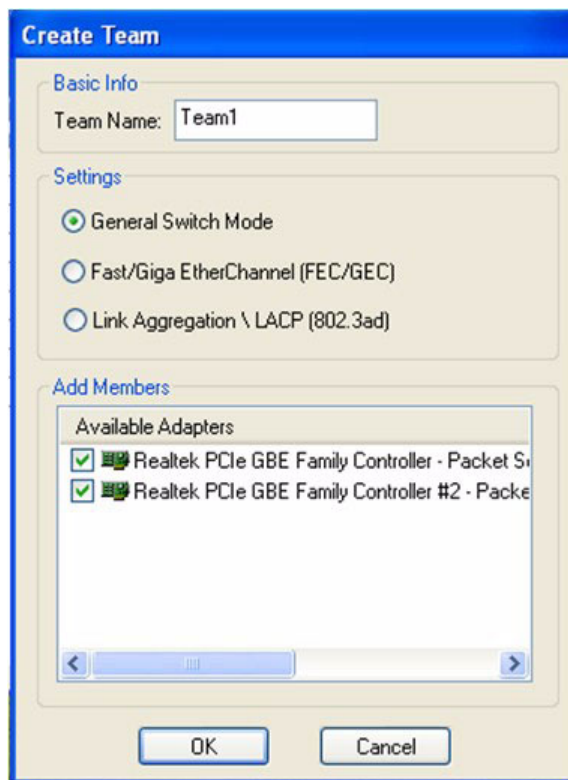

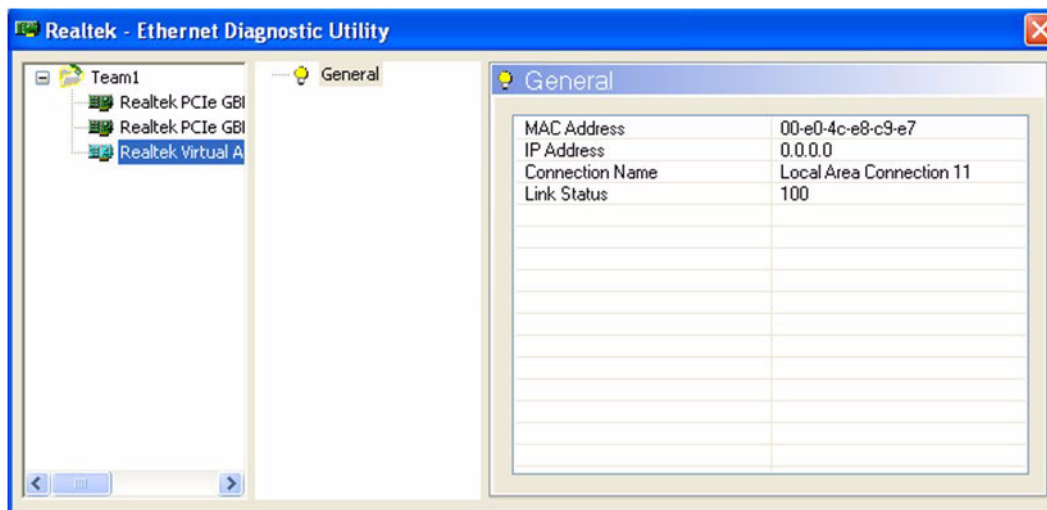

## 6. Create Teaming Function Completed.

**Teaming Testing Notes**

1. The gigabit switch prefer supporting teaming function (likely FEC/GEC, LACP...) If the gigabit switch doesn't support teaming function, the performance of Inbound Traffic (Rx) will only have one adapter performance.
2. Take care the teaming switch how to decide the port to send packets. Although the teaming switch could upgrade the Rx performance, some particulars would cause the Rx performance same with not using gigabit teaming switch. The Rx traffic of the teaming server is from client to server through the teaming switch. So, if the teaming switch decides which port to send the packets by the information of the client, the situation all packets form client to server send by the same port may be occurred. For example, some gigabit teaming switches decide the port send the packets by the last-bit MAC address of the client (Source). So, if the last-bit MAC address of the two clients is the same, all the packets will send by the same port. Therefore, the teaming only has one adapter to receive the packets. That causes the Rx performance cannot upgrade. The solution is to make sure the last-bit MAC address of the two clients is different.
3. Teaming switch has the port mirror function  
Some switches have the port mirror function. We need to disable to function or not to plug in these ports.
4. Server and Switch mode is conflict  
In general case, the mode of the teaming server and the teaming switch should be the same. When the mode of the teaming server is LACP and the mode of the teaming switch is FEC/GEC, the adapters will send LACP packets to negotiate the ports with the switch that will make up the team. But teaming switch will ignore the LACP packets and the network works likely FEC/GEC mode. When the mode of the teaming server is FEC/GEC and the mode of the teaming switch is LACP, the teaming switch will send LACP packets to the teaming server and wait the response form the teaming server. But the teaming server will not reply the teaming switch due to set FEC/GEC mode. So, the teaming is failed.

## A.11.2 Remove Teaming Flow

1. Start the Utility software  
From the start up menu, left click the icon in All Programs→Realtek→Diagnostic Utility→Realtek Ethernet Diagnostic Utility, as shown in the figure below:

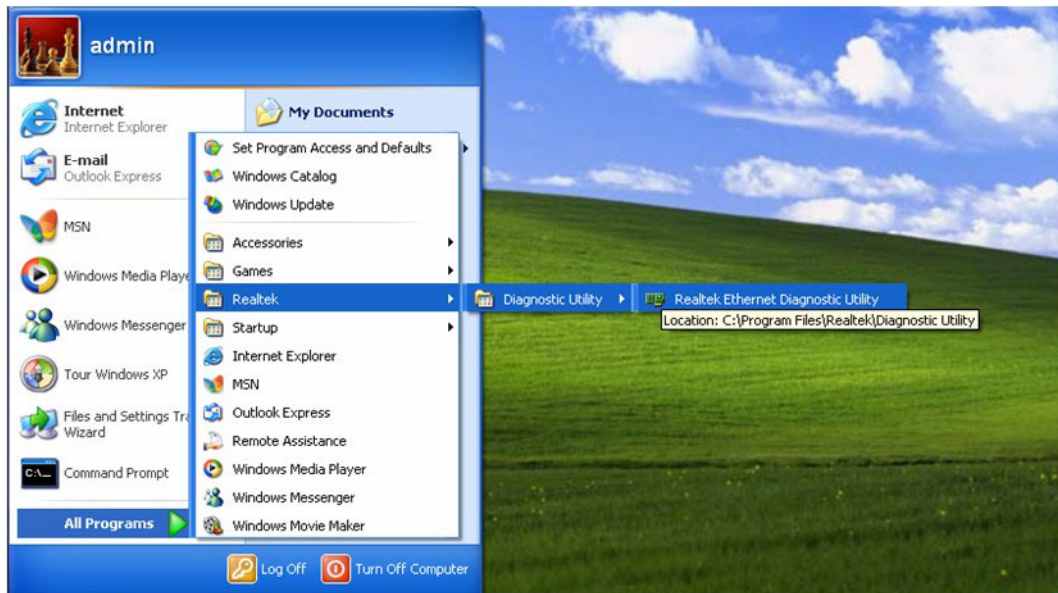

2. Select Remove Teaming  
Select the team Name of the teaming which want to remove

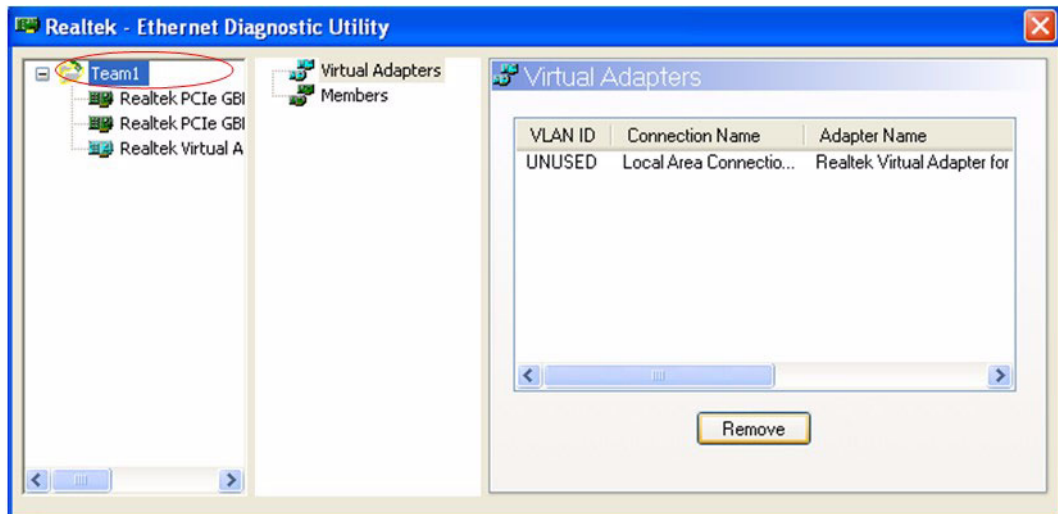

3. Select Remove Virtual Adapter  
Select the Virtual adapter of the teaming which want to remove.

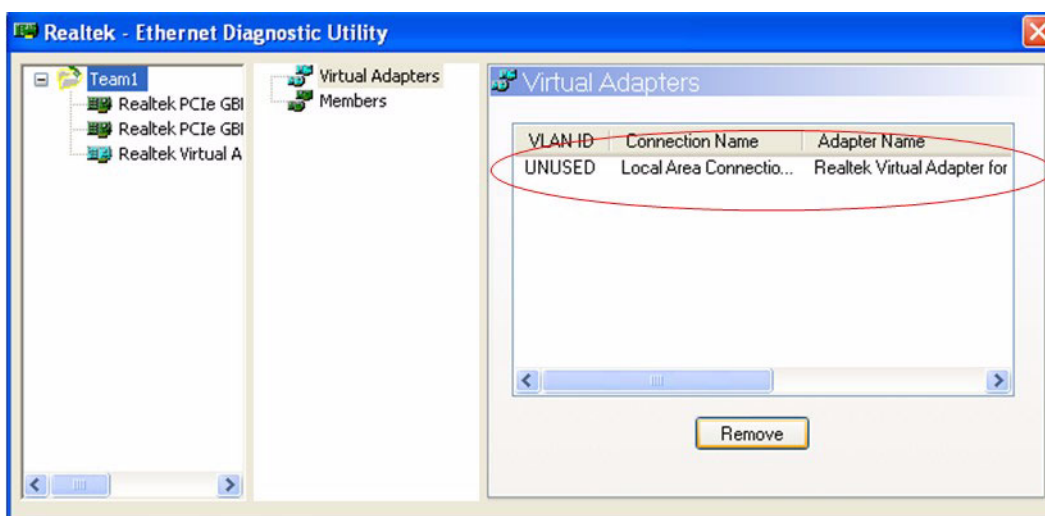

4. Start to Remove Teaming  
Left click the icon "Remove" on the Dialog.

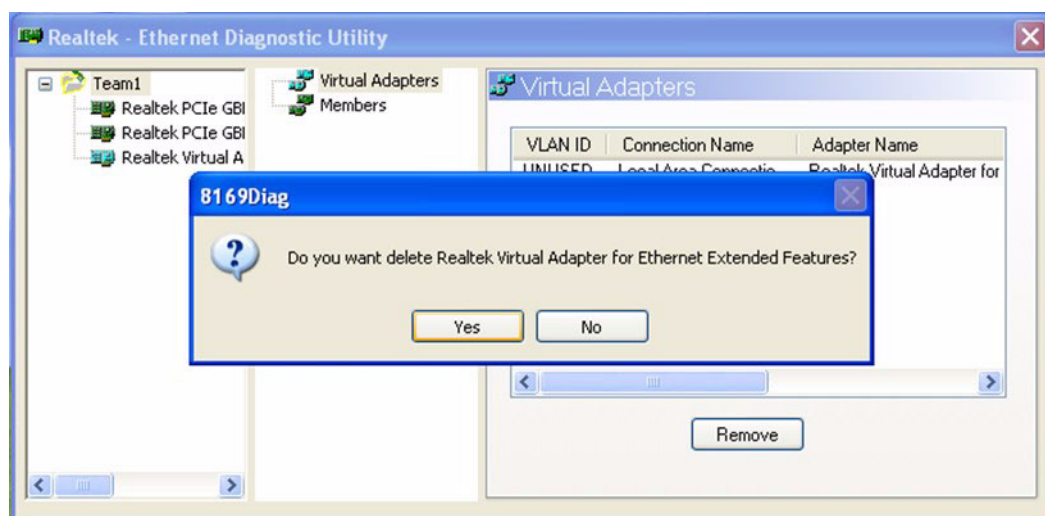
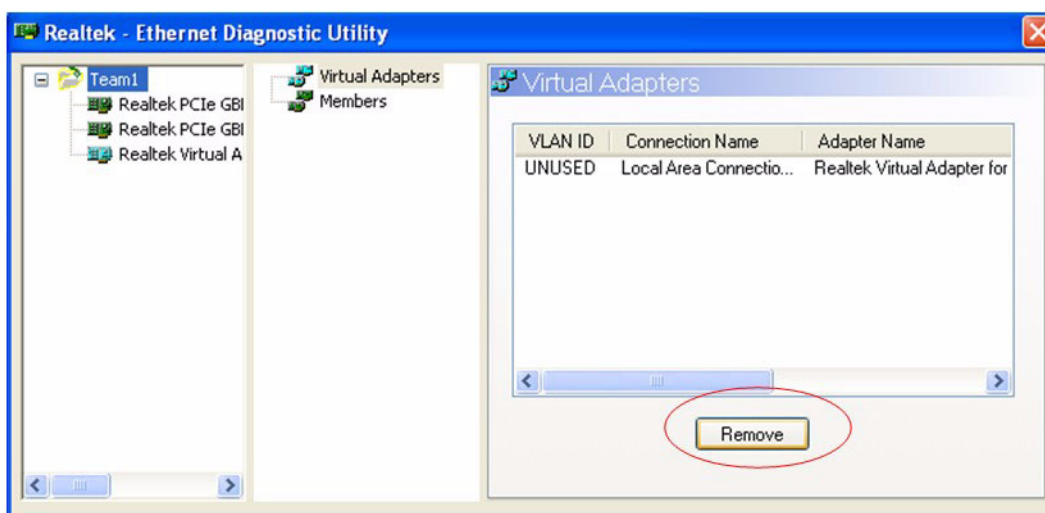

**ADVANTECH**

*Enabling an Intelligent Planet*

**[www.advantech.com](http://www.advantech.com)**

Please verify specifications before quoting. This guide is intended for reference purposes only.

All product specifications are subject to change without notice.

No part of this publication may be reproduced in any form or by any means, electronic, photocopying, recording or otherwise, without prior written permission of the publisher.

All brand and product names are trademarks or registered trademarks of their respective companies.

© Advantech Co., Ltd. 2011